

# ANDERSEN PRICELIST FURNITURE

EUR – RETAIL EXCL. VAT

AT – BE – CH – CZ – EE – ES – FR – IS – LT – LV – NL – PL – PT – RO – SK

VALID FROM 01.06 2026



**ANDERSEN**  
QUALITY MEETS DESIGN

- A part of Design Concept Denmark



# CONTENTS

General information	4		
Care kits	6		
<b>TABLES</b>	<b>7</b>		
AD1 - Series	9		
AD1 - Tables	10		
AD1 - High tables	11		
AD1 - Extendable tables	12		
AD1 - Bench	13		
Andersen - High tables	14		
Classic 255 /290 - Extendable tables	16		
Delta - Tables with bases	18		
DK10 - Extendable tables	20		
Grip - Tables	22		
Grip Basic - Tables	23		
Grip Metting - Tables	25		
Grip Wood - Tables	27		
Grip Powerbox	28		
Link - Tables	29		
Link Bar - High tables	34		
Link - Features / Accessories	35		
Space - Tables	37		
Space - High tables	40		
Space - Flip tables	41		
Space - Extendable tables	42		
Space Add - Table	43		
Tube - Tables	45		
Tube - Collection	46		
Tube - Weight Overview	48		
Tube Basic - Tables	49		
Tube Fold - Tables	53		
Tube Wood - Tables	57		
Tube Counter - High tables	59		
Tube Stay - Tables	60		
Tube - Modesty Panel / End Panel	63		
Tube - Transport Trolley	63		
T1 - Series	65		
T1 - Tables	66		
HT1 - High tables	68		
T1 - Extendable tables	70		
B2 - Bench	71		
T3 - Extendable tables	72		
T7 - Extendable tables	74		
T8 - Tables	76		
T9 - Extendable tables	78		
T10 - Extendable table	80		
T11 - Extendable table	81		
Solutions for cables & power	82		
D1 - Desk	84		
<b>COFFEE TABLES</b>	<b>85</b>		
C1 - Coffee tables	86		
C2 - Coffee tables	88		
C6 - Coffee tables	89		
Evoke - Coffee tables	90		
<b>CHAIRS</b>	<b>91</b>		
Fabric overview - Chairs	92		
AC2 - Chair	94		
Anch - Chair	97		
Dry - Chair	98		
Anch - Chair	100		
Dry Outdoor - Chair	101		
HC1 - Bar stool	102		
HC2 - Bar stool	104		
		Mood - Chairs	105
		Mood 4-legs - Chair	106
		Mood 4-legs - Arm chair	107
		Mood Tube - Chair	108
		Mood Low - Bar stool	109
		Mood High - Bar stool	110
		Mood Conference - Chair	111
		Mood Wood - Chair	112
		Mood Classic - Chair	113
		Mood Learn - Chair	114
		Mood Learn - Arm chair	115
		Mood Learn - Chair	116
		Pure - Chairs	117
		Pure - Chair	118
		Pure - Stool / Bar stool	119
		Pure X - Chair	120
		Rail - Chairs	121
		Rail - Chair	122
		Scope - Chairs	123
		Scope - Chair	124
		Scope - Arm chair	125
		Scope - Stool / Bar stool	126
		Scope - Lounge chair	127
		Scope Retail - Chair	128
		Scope Retail - Arm chair	129
		TAC - Chairs	130
		Tono - Chairs	132
		Tono 4-legs - Chair	133
		Tono Wood - Chair	134
		Tono Conference - Chair	135
		Unite - Chair	136
		Chair trolleys / Chair suspension	137
		<b>SOFAS/LOUNGE</b>	<b>139</b>
		Fabric / Leather groups - Sofas	140
		A1 Sofa & Pouf	141
		A2 - Sofa	142
		A2 - Sofa - Diner	143
		A3 - Sofa	144
		LC1 - Loungechair	146
		<b>STORAGE</b>	<b>147</b>
		S1 - Sideboard	148
		S2 - Shelf system	150
		S2 - Shelf system (Height 51 cm)	151
		S2 - Shelf system (TV-Modul)	152
		S3 - S5 - S6 - S7 - S8 Series	153
		S3 / S5 - Storage	154
		S6 / S7 - Sideboard	155
		S8 - Storage	156
		S10 Signature - Cabinets	157
		Uniques - Sideboard	158
		<b>RUGS</b>	<b>158</b>
		Flow - Rugs	161
		<b>DESIGN INTERIOR</b>	<b>163</b>
		Living	166
		Shelves	171
		Textiles	177
		Kitchen	178
		Bath	181
		Furniture	183

# GENERAL INFORMATION

## Conditions of sale and terms of delivery:

This pricelist is valid from 01.06 2026 and will replace all previous pricelists.  
Current sale terms should at all times be observed.

Please send orders to: [order@designconceptdenmark.dk](mailto:order@designconceptdenmark.dk)

The order is registered and accepted when written order confirmation is present.

Confirmed delivery time is ex. works. It is the customers responsibility to check order confirmations forwarded by Design Concept Denmark and thereby reassure that it is consistent with the order.

If your order is not already packed and in transit, you can cancel the order within 24 hours.

All orders require a credit approval equal to the total order amounts.

Design Concept Denmark may postpone delivery of any order or cancel orders in writing without incurring any liability for them if the buyer or companies or persons affiliated with the buyer have any unpaid overdue invoices relating to previously delivered orders or otherwise have any outstanding unpaid amounts.

We accept no liability for misprints, image errors, price changes, discontinued goods or errors.

## Environmental fee

All orders will be charged an EUR 11,- environmental fee.

## Breach of sales colli

It is not possible to break the sales unit.

## Transportinformation:

Delivery terms: DAP

Note regarding UK and CH: Regardless of DAP delivery terms, a customs clearance fee of EUR 50 will be charged.

This is to ensure the most efficient and cost-effective customs clearance for the customer

For orders lower than EUR 600,- net excl. VAT there will be a freight cost on EUR 75,-

Free shipping on orders above EUR 600,- net excl. VAT

The above freight condition will only include mainland. The freight condition will NOT apply to islands and the rest of the world – here we will calculate an actual freight charge.

Please note that we only ship to warehouse addresses and if your address requires repacking to a smaller vehicle, a surcharge can be added.

## Damage during transport:

If the goods are damaged during transportation, or a suspicion occurs, the goods MUST be examined and any damages reported to the forwarding agent immediately, therefore the packaging must be examined carefully when receiving the goods. Design Concept Denmark cannot be held responsible for transport damages that are reported after the deadline according to the carrier's conditions.

## Complaints:

Agreement required for returning goods. When returning goods, the furniture damaged MUST be wrapped up securely. Design Concept Denmark is not responsible for any transportation damages which are caused by inadequately packing.

If there is no visible damage to the packaging, transport damage must be reported no later than 7 days after receiving the goods  
If an order has been transported further, all cover for nonvisible damage is waived. In case of missing number of colli and/ or packaging, this must be reported no later than 7 days after receiving the order.

## GENERAL INFORMATION

Returning goods: Design Concept Denmark will pay the transport costs from/to Design Concept Denmark and the customer. If the claim hasn't been approved by Design Concept Denmark the customer pays for the transport. It is the customer's responsibility to inspect the claim together with a representative from Design Concept Denmark. Design Concept Denmark will make an assessment whether the claim shall be repaired or replaced. The customer cannot demand a refund by repairing the claim.

### Limitations of liability:

Design Concept Denmark will assume no liability for any loss as a result of delays, defects or any other breach of contract, unless such loss was caused by gross negligence on the part of Design Concept Denmark. Design Concept Denmark will assume no liability for any indirect loss, including loss of profits, operating loss, goodwill, loss of customers, running costs or any other consequential economic loss.

### Measurement:

Please note that a difference in measurement may occur.

### Targets, Technical Information and Intellectual Rights:

Product information, illustrations, drawings, information on technical data (e.g. weight, dimensions, volume, strength, load capacity and surface), materials in catalogues, brochures or other materials are solely indicative. We reserve the right to modify specifications and descriptions without warning. All drawings and technical documents regarding products are the property of Design Concept Denmark and may not be copied, reproduced or disclosed to third parties.

Design Concept Denmark retains ownership of all intellectual property rights associated with the products, and the buyer does not obtain any right to make use of Design Concept Denmark's intellectual property rights above and beyond what may be necessary for the normal use of the purchased products.

### Ownership

Design Concept Denmark shall retain the ownership rights to the delivered products until the buyer has paid the entire purchase amount in full plus any incurred costs.

### Guarantee and liability:

Design Concept Denmark grants a 2-year guarantee on all products in our official price lists. The guarantee shall be voided if the product shows signs of misuse, improper handling or other physical damage.

No guarantee is provided for damage occurring as a result of incorrect fitting by a third-party fitter. Design Concept Denmark may never be held liable for indirect losses, such as operating losses, loss of profit, loss of income or other indirect losses, regardless of whether such losses are due to liability for defects, delays, products or similar.

The amount of Design Concept Denmark's liability for compensation is always limited to the amount of the order that gave rise to the liability for compensation.

Minor defect in the laminate can occur, which are within the supplier's tolerance and permitted values according to the European standard EN438. In addition a colour difference between table and leaves can occur.

Direct sunlight, heat, alcohol and moisture are bad for wooden furniture. Regardless of how the wood is treated, we therefore recommend limiting direct sunlight and avoiding direct contact with heat and moisture. For optimal treatment of the product, we refer to our treatment instructions.

## CARE KITS

Care kits		Min. order quantity	Price
9-OL005L	White oil - No. 760 (bottle with 250 ml.)	12	31
9-OL005M	Natural oil - nature/dark - no. 244 (bottle 250 ml.)	12	31
9-100-006S	Care kit contain. 240 gr. white soapflakes, sand paper and sprong	12	27
9-100-008S	White soapflakes (bag 500 gr.)	8	15
9-100-007	Laminate cleaning (500 ml. bottle with spray)	12	19
9-100-009	Linoleum cleaning (500 ml. bottle with spray)	12	19
9-200	Repair lacquer	1	19

# TABLES





# AD1 - SERIES

Design: Andersen Design Team

## TABLE TOP - LAMINATE (HPL)



White (Alpino)  
K1040



Kashmir  
F0187



Cafe  
F0903



Terril  
F2297



Diamond Black  
F2253



Ocean Grey  
F7853



Pumice  
F7858



Silver  
F2791



Iron  
F7902



Pale Olive  
F3007



Artic Blue  
F5493



Lead  
F7924



Mouse  
F7928

## TABLE TOP - FENIX LAMINATE



Black (Nero Ingo)  
0720



Bianco Male  
0029



Beige Luxor  
0719



Beige Arizona  
0748



Castoro Ottawa  
0717



Cacao Orinoco  
0749



Grigio Efeso  
0725



Grigio Antrim  
0752



Grigio Londra  
0718



Grigio Bromo  
0724



Rosso Jaipur  
0751



Verde Comodoro  
0750



Blu Fes  
0754

## TABLE TOP - LINOLEUM



Black (Nero)  
4023



Ash  
4132



Burgundy  
4154



Mauve  
4172



Mushrom  
4176



Olive  
4184



Pebble  
4175



Pewter  
4155



Pistachio  
4183



Smokey Blue  
4179



Vapour  
4177



Charcoal  
4166



Conifer  
4174

## LEGS / SUPPORTING FRAME



Oak  
Whitepig. matt lacquer



Oak  
Smoked matt lacquer



## AD1 - TABLES

Design: Andersen Design Team

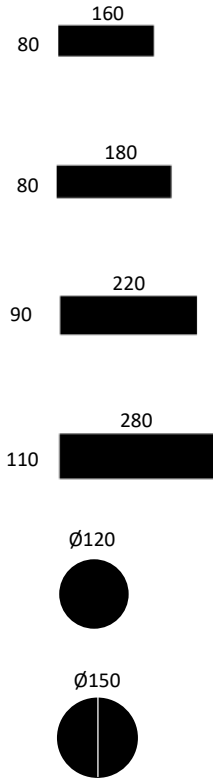

Table top	White Laminate (HPL)	Coloured Laminate (HPL)	Black Fenix Laminate *	Black Linoleum **
Edge	Edge whitepainted ***	Edge blackpainted ***	Edge blackpainted ***	Edge blackpainted ***
<b>0-6001- 160x80xH73,5 cm</b> Legs: Oak - Lacquered (Whitepig. or smoked lacquer)	<b>1.388</b>	<b>1.500</b>	<b>1.597</b>	<b>1.597</b>
<b>0-6003- 180x80xH73,5 cm</b> Legs: Oak - Lacquered (Whitepig. or smoked lacquer)	<b>1.454</b>	<b>1.571</b>	<b>1.673</b>	<b>1.673</b>
<b>0-6005- 220x90xH73,5 cm</b> Legs: Oak - Lacquered (Whitepig. or smoked lacquer)	<b>1.522</b>	<b>1.642</b>	<b>1.749</b>	<b>1.749</b>
<b>0-6007- 280x110xH73,5 cm</b> Legs: Oak - Lacquered (Whitepig. or smoked lacquer)	<b>1.986</b>	<b>2.146</b>	<b>2.285</b>	<b>2.285</b>
<b>0-6020- Ø120xH73,5 cm</b> Legs: Oak - Lacquered (Whitepig. or smoked lacquer)	<b>1.256</b>	<b>1.356</b>	<b>1.444</b>	<b>1.444</b>
<b>0-6040- Ø150xH73,5 cm</b> Legs: Oak - Lacquered (Whitepig. or smoked lacquer)	<b>1.786</b>	<b>1.931</b>	<b>2.056</b>	<b>2.056</b>

### Surcharge

\* Additional fee for other Fenix laminate colours than black: 15%

\*\* Additional fee for other linoleum colours than black: 15%

\*\*\* Additional fee for oak veneer edge banding or edge painted in colour as laminate: 10%

Model 0-6001-

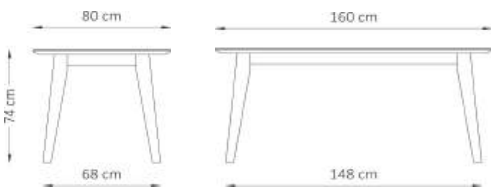

Model 0-6007-

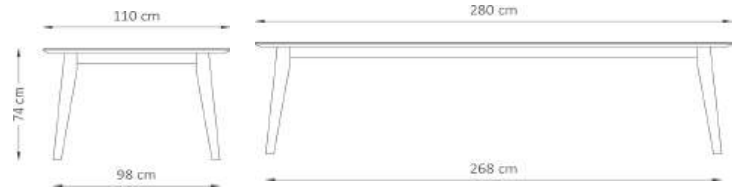

Model 0-6003-

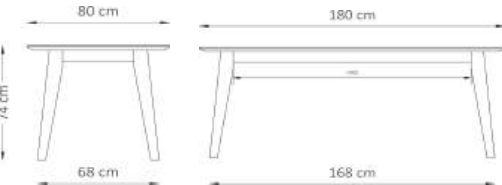

Model 0-6020-



Model 0-6005-



Model 0-6040-

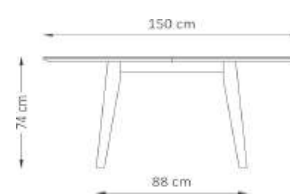



## AD1 - HIGH TABLES

Design: Andersen Design Team

Tabletop	White Laminate (HPL)	Coloured Laminate (HPL)	Black Fenix Laminate*	Black Linoleum**
Edge	Edge whitepainted ***	Edge blackpainted ***	Edge blackpainted ***	Edge blackpainted ***

### Height 93 cm

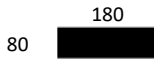

#### 0-60702- 180x80xH92,5 cm

Legs: Oak - Lacquered (Whitepig. or smoked lacquer)

1.522

1.642

1.749

1.749

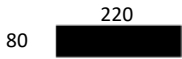

#### 0-60712- 220x80xH92,5 cm

Legs: Oak - Lacquered (Whitepig. or smoked lacquer)

1.654

1.786

1.902

1.902

### Height 105 cm

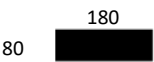

#### 0-60701- 180x80xH104,5 cm

Legs: Oak - Lacquered (Whitepig. or smoked lacquer)

1.522

1.642

1.749

1.749

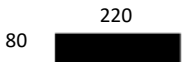

#### 0-60711- 220x80xH104,5 cm

Legs: Oak - Lacquered (Whitepig. or smoked lacquer)

1.654

1.786

1.902

1.902

### Surcharge

\* Additional fee for other Fenix laminate colours than black: 15%

\*\* Additional fee for other linoleum colours than black: 15%

\*\*\* Additional fee for oak veneer edge banding or edge painted in colour as laminate: 10%

Model 0-60702- / 0-60712-



Model 0-60702-



Model 0-60712-



Model 0-60701- / 0-60711-



Model 0-60701-

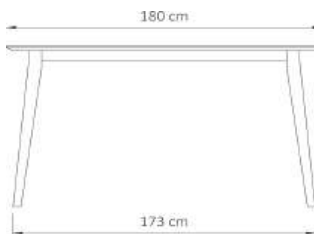

Model 0-60711-





## AD1 - EXTENDABLE TABLE

Design: Andersen Design Team

Table top	White Laminate (HPL)
Edge	White lacquered Bevelled

Ø110



<b>0-6010-</b>	<b>Ø110xH74 cm</b>	
Extension for 2 leaves		
Legs: Oak/Whitepigmented matt lacquer		<b>1.444</b>

<b>Leaf</b>		
<b>0-6011-</b>	<b>110x50 cm</b>	
White laminate		<b>259</b>

### PRODUCT HIGHLIGHTS

- W 32 kg / CBM 0,18

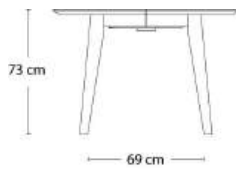



# AD1 - BENCH

Design: Andersen Design Team

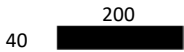

Seat	White Laminate (HPL)	Oak Whitepig. matt lacquer
------	-------------------------	-------------------------------

<b>0-6320A1010213</b>	<b>200x40xH45 cm</b>	
Legs: Oak/Whitepigmented matt lacquer	<b>1.388</b>	
<b>0-6320M0213</b>	<b>200x40xH45 cm</b>	
Legs: Oak/Whitepigmented matt lacquer		<b>1.522</b>

### PRODUCT HIGHLIGHTS

- W 25 kg / CBM 0,10



# ANDERSEN - HIGH TABLES

Design: Andersen Design Team

## HIGH TABLE - LAMINATE (HPL)



White full coloured

## HIGH TABLE - FENIX LAMINATE



Black (Nero Ingo)  
0720

## HIGH TABLE - OAK VENEER



Oak

Whitepig. matt lacquer



Oak

Clear matt lacquer







## ANDERSEN - HIGH TABLES

Design: Andersen Design Team

Tabletop	Solid white Laminate*	Black Fenix Laminate*	Oak veneer Lacquer**
Edge	Edge whitepainted	Edge blackpainted	Edge banding in oak veneer

Height 93 cm Without footrest	Bevelled edge C Mitre joint	Straight edge E Butt joint
-------------------------------	-----------------------------	----------------------------

60 	0-3710- 180x60xH93 cm	2.707	2.905	2.769
--	-----------------------	-------	-------	-------

80 	0-3715- 180x80xH93 cm	3.549	3.944	2.781
--	-----------------------	-------	-------	-------

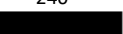
60 	0-3720- 240x60xH93 cm	2.766	2.964	3.081
--	-----------------------	-------	-------	-------

80 	0-3725- 240x80xH93 cm	3.581	3.976	3.092
--	-----------------------	-------	-------	-------

Height 108 cm With footrest in brushed stainless steel	Bevelled edge C Mitre joint	Straight edge E Butt joint
--	-----------------------------	----------------------------

60 	0-3810- 180x60xH108 cm	3.103	3.405	3.164
--	------------------------	-------	-------	-------

80 	0-3815- 180x80xH108 cm	3.858	4.254	3.186
--	------------------------	-------	-------	-------

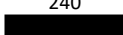
60 	0-3820- 240x60xH108 cm	3.256	3.559	3.627
--	------------------------	-------	-------	-------

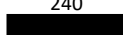
80 	0-3825- 240x80xH108 cm	3.975	4.371	3.639
--	------------------------	-------	-------	-------

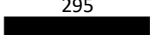
60 	0-3830- 295x60xH108 cm	3.346	3.676	
--	------------------------	-------	-------	--

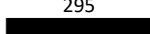
80 	0-3835- 295x80xH108 cm	4.019	4.442	
--	------------------------	-------	-------	--

Laminate on 28 mm MDF

\*\* Choose between surface in: White pigm. matt lacquer / Clear matt lacquer

### PRODUCT HIGHLIGHTS

- The high tables have adjustable feet attached and integrated wheels in one of the panels

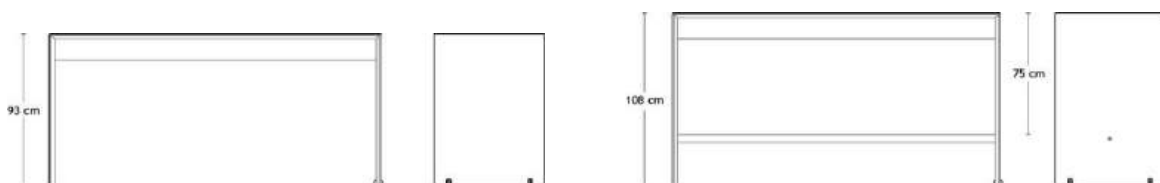

# CLASSIC 255 / 290 - EXTENDABLE TABLES

Design: Andersen Design Team

## TABLE TOP & LEGS - SOLID OAK



Oak  
White oil



Oak  
Natural oil



Oak  
Soap

Edge - Choose between:



Full rounded edge B



Bevelled edge C

Model 2-255L / 2-255XL



Model 2-255L

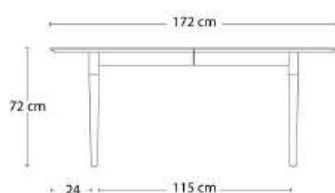

Model 2-255XL

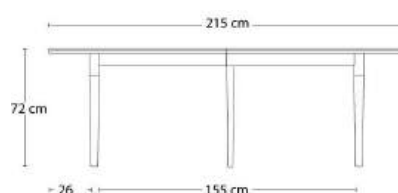

Model 2-265 / 2-265XL

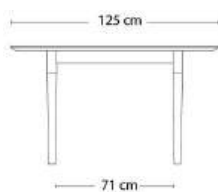

Model 2-265

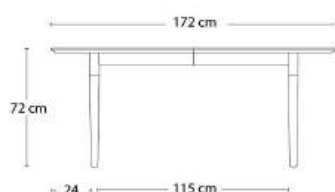

Model 2-265XL

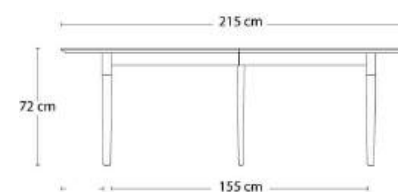

Model 2-290

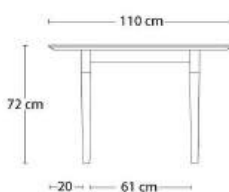

2-295

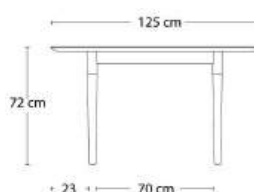



## CLASSIC 255 / 290 - EXTENDABLE TABLES

Design: Andersen Design Team

Tabletop and legs in solid wood

Oak  
Soap

Oak  
Oil \*

**The tables has an extension for 3 leaves. Can be supplied with extra extension at an additional cost**

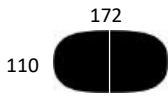

### 2-255L 110x172xH72 cm

Possibility of extension for max. 8 leaves

Oak (1 pc. black supporting leg included)

2.651

2.773

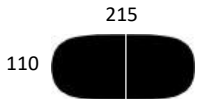

### 2-255XL 110x215xH72 cm

Possibility of extension for max. 8 leaves

Oak (1 pc. supporting leg in oak intended for permanent use included)

3.014

3.136

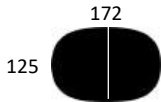

### 2-265 125x172xH72 cm

Possibility of extension for max. 8 leaves

Oak (1 pc. black supporting leg included)

2.651

2.773

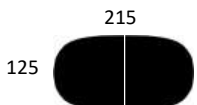

### 2-265XL 125x215xH72 cm

Possibility of extension for max. 8 leaves

Oak (1 pc. supporting leg in oak intended for permanent use included)

3.014

3.136

Ø110



### 2-290 Ø110xH72 cm

Possibility of extension for max. 5 leaves

Oak (1 pc. black supporting leg included)

2.410

2.531

Ø125



### 2-295 Ø125xH72 cm

Possibility of extension for max. 5 leaves

Oak (1 pc. black supporting leg included)

2.531

2.651

Leaves

Anthracite  
grey

Oak  
Soap

Oak  
Oil

#### Leaf for model 2-255 / 2-290

2-256 110x50 cm

780

839

2-257 110x50 cm

332

#### Leaf for model 2-265 / 2-295

2-296 125x50 cm

780

839

2-297 125x50 cm

356

#### Surcharge - Extra extension

For 4  
leaves

For 5 eller  
6 leaves

For 7 eller  
8 leaves

Number of included black supporting legs

4

6

6

337

453

536

#### Surcharge - Table height 74 cm

120

#### Surcharge - Supporting leg in oak (per leg)

27

\* Oak/Oil - Choose between: White oil - Natural oil

#### PRODUCT HIGHLIGHTS

- Model 255L: W 60 kg / CBM 0,22

- Model 255XL: W 70 kg / CBM 0,27

- Model 265L: W 60 kg / CBM 0,25

- Model 265XL: W 80 kg / CBM 0,33

- Model 290: W 55 kg / CBM 0,15

- Model 295: W 55 kg / CBM 0,15

# DELTA - TABLES WITH BASES

Design: Andersen Design Team

## TABLE TOP - LAMINATE (DECOR)



Light Grey

## TABLE TOP - LAMINATE (HPL)



White  
NCS S500-N



Light Grey  
F7961

## TABLE TOP - FENIX LAMINATE



Black (Nero Ingo)  
0720



Grigio Londra  
0718

## TABLE TOP - LINOLEUM



Black (Nero)  
4023

## BASE



Black matt powder coated  
RAL 9005

Bases  
Item no.

40x40xH72,5 cm  
D0-404070001H0725

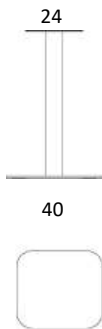

60x40xH72,5 cm  
D0-604070001H0725

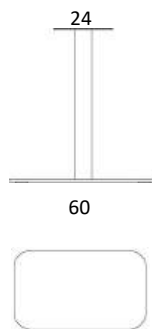

Ø45xH72,5 cm  
D0-457000001H0725

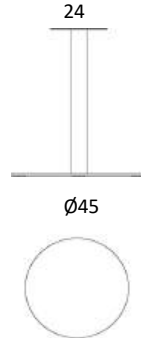

60x60xH72,5 cm  
D0-X6070001H0725

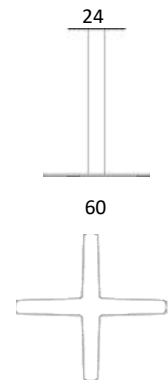



## DELTA - TABLES WITH BASES

Design: Andersen Design Team

Tabletop	Decor Laminate	HPL Laminate	Fenix Laminate	Linoleum*	HPL Laminate	Fenix Laminate	Linoleum*
Edge	ABS edge				Plywood edge Clear lacquer		

70 

### DE-101- 70x70xH74,5 cm

Table top with optional Delta column base

1-4 pcs.

700 737 822 842 842 925 893

**5+ pcs.**

**559 597 681 702 700 785 753**

Choose between column base: 40x40 cm - Ø45 cm - 60x60 cm

79 

### DE-102- 79x79xH74,5 cm

Table top with optional Delta column base

1-4 pcs.

712 763 869 880 886 997 944

**5+ pcs.**

**571 622 729 739 746 856 803**

Choose between column base: 40x40 cm - Ø45 cm - 60x60 cm

90 

### DE-103- 90x90xH74,5 cm

Table top with optional Delta column base

1-4 pcs.

725 788 924 922 931 1.069 993

**5+ pcs.**

**583 649 783 781 790 927 853**

Choose between column base: 40x40 cm - Ø45 cm - 60x60 cm

70 

### DE-110- 120x70xH74,5 cm

Table top with Delta column base 60x40 cm

1-4 pcs.

763 834 983 988 990 1.142 1.120

**5+ pcs.**

**622 693 842 847 849 1.002 980**

79 

### DE-111- 120x79xH74,5 cm

Table top with Delta column base 60x40 cm

1-4 pcs.

771 853 1.024 1.029 1.025 1.200 1.175

**5+ pcs.**

**631 712 883 888 883 1.059 1.034**

Ø79 

### DE-120- Ø79xH74,5 cm

Table top with optional Delta column base

1-4 pcs.

759 812 920 912 873 983 931

**5+ pcs.**

**617 671 780 771 732 842 790**

Choose between column base: 40x40 cm - Ø45 cm - 60x60 cm

Ø90 

### DE-121- Ø90xH74,5 cm

Table top with optional Delta column base

1-4 pcs.

775 842 976 953 912 1.051 973

**5+ pcs.**

**632 700 836 812 771 908 832**

Choose between column base: 40x40 cm - Ø45 cm - 60x60 cm

Ø100 

### DE-122- Ø100xH74,5 cm

Table top with Delta column base 60x60 cm

1-4 pcs.

861 944 1.110 1.139 1.024 1.195 1.207

**5+ pcs.**

**719 803 969 998 883 1.053 1.066**

Ø110 

### DE-123- Ø110xH74,5 cm

Table top with Delta column base 60x60 cm

1-4 pcs.

878 978 1.178 1.192 1.068 1.275 1.264

**5+ pcs.**

**737 839 1.037 1.051 927 1.132 1.124**

Choice of other colours - Formica Colors, Forbo Linoleum and Fenix laminate: 10% surcharge

### Surcharge

Tilting functionality mounted on table

24

# DK10 - EXTENDABLE TABLES

Design: Ditlev Karsten

## TABLE TOP - LAMINATE (HPL)



White (full coloured)

## TABLE TOP - SOLID WOOD



Oak  
Soap



Oak  
Natural oil

## LEGS / SUPPORTING FRAME



Oak  
White oil



Oak  
Natural oil



Oak  
Soap



Chrome



# DK10 - EXTENDABLE TABLES

Design: Ditlev Karsten



Tabletop in laminate

Solid white  
Laminate

Edge

Edge  
whitepainted

**0-8200 110x190xH72 cm**

Extension for 3 leaves

Legs in chromed steel

**2.168**

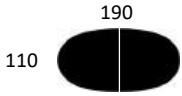

**0-8205 110x190xH72 cm**

Extension for 3 leaves

Oak/Soap legs

**2.168**

Oak/Oil (White oil/Natural oil) legs

**2.168**



Leaf

Solid white  
Laminate

**Leaf**

**0-8209 50x110 cm**

**344**

**Table legs**



Chrome



Oak/Soap



Oak/Oil

**Table top**



White Laminate



**Table top and legs in solid oak**

Oak  
Soap

Oak  
Natural oil

**0-8230 110x190xH72 cm**

Extension for 3 leaves

Oak

**2.290**

**2.410**

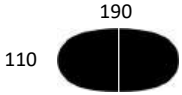

Leaf

Anthracite grey  
lacquered

Oak  
Soap

Oak  
Natural oil

**Leaf**

0-8294 50x110 cm

**271**

0-8293 50x110 cm

**598**

**658**

**Table top / Legs**



Oak/Soap



Oak/Natural oil

## PRODUCT HIGHLIGHTS

Model 2-5702: W 68 kg / CBM 0,27

Model 0-8220



Model 0-8225 / 0-8230

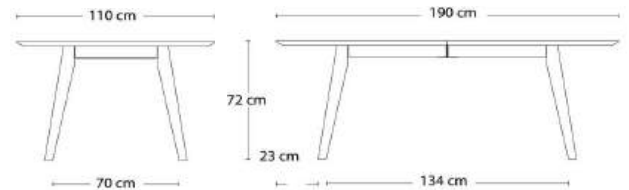

# GRIP - TABLES

Design: Troels Grum-Schwensen

## TABLE TOP - LAMINATE (HPL)



White  
NCS S500-N



Light Grey  
F7961

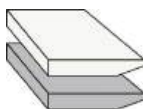

Edge profile chamfered - Lacquered

## TABLE TOP - FENIX LAMINATE



Black (Nero Ingo)  
0720



Grigio Londra  
0718



Edge profile chamfered - Lacquered

## TABLE TOP - LINOLEUM



Black (Nero)  
4023



Edge profile chamfered - Lacquered

## TABLE TOP - VENEER



Oak  
Veneer



Edge profile chamfered - Lacquered

## FRAME COLOURS - GROUP 1



Black  
RAL 9005

## FRAME COLOURS - GROUP 2



Dark Petrol  
NCS 7010 B10G



Dusty Green  
NCS S6010 G10Y



Sandy Grey  
NCS 5502Y



Dusty Olive  
RAL 7009



Terracotta  
RAL 8002



Warm Charcoal  
RAL 7022



## GRIP BASIC - TABLES

Design: Troels Grum-Schwensen

Frame	Frame black Lacquered**	Frame colour Lacquered**
Edge	Edge profile chamfered lacquered	

### G69100 - 131x80xH73,5 cm, 2 legs

131  
80

HPL laminate	1.856	1.898
Fenix laminate	1.997	2.041
Linoleum	1.941	1.985
Veneer*	2.136	2.183

### G69110 - 179x80xH73,5 cm, 2 legs

179  
80

HPL laminate	1.939	1.981
Fenix laminate	2.139	2.181
Linoleum	2.024	2.066
Veneer*	2.225	2.273

### G69120 - 239x80xH73,5 cm - 2 legs

239  
80

HPL laminate	2.217	2.397
Fenix laminate	2.478	2.622
Linoleum	2.327	2.514
Veneer*	2.561	2.608

### G69130 - 299x80xH73,5 cm - 2 legs

299  
80

HPL laminate	2.619	2.739
Fenix laminate	2.880	3.037
Linoleum	2.739	2.946
Veneer*	2.897	2.946

### Surcharge

G69900 - GRIP leg	447	492
G69500 - GRIP linking device		120

\*Please note deviation in colour and grain may occur and we cannot recommend linking veneer tables. Other finishes and colours are available upon request, please contact our sales office.

Choice of other colours: Formica Colors and Forbo Linoleum + 10%

### Frame colour

\*\*Lacquered



Dark  
Petrol



Dusty  
Green



Sandy  
Grey



Dusty  
Olive



Terra-  
cotta



Warm  
Charcoal

### PRODUCT HIGHLIGHTS

- Modular construction - the table can be expanded and linked
- Removable legs, allows you to adjust positioning to meet individual needs
- Media integration is available - Grip powerbox
- Extremely stable frame construction
- Up to 3m span between the legs



## GRIP BASIC - TABLES

Design: Troels Grum-Schwensen

Frame	Frame black Lacquered**	Frame colour Lacquered**
Edge	Edge profile chamfered lacquered	

### G69140 - 359x80xH73,5 cm - 3 legs, table top in 2 parts (2x179 cm)



HPL laminate	3.547	3.612
Fenix laminate	3.944	4.010
Linoleum	3.715	3.781
Veneer*	4.086	4.158

### G69150 - 443x80xH73,5 cm - 4 legs, table top in 3 parts (2x131, 1x179 cm)

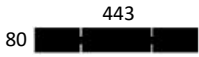

HPL laminate	4.988	5.075
Fenix laminate	5.469	5.556
Linoleum	5.237	5.324
Veneer*	5.761	5.856

### G69160 - 479x80xH73,5 cm - 3 legs, table top in 2 parts (2x239 cm)



HPL laminate	4.263	4.414
Fenix laminate	4.622	4.922
Linoleum	4.408	4.651
Veneer*	4.754	4.825

### G69170 - 563x80xH73,5 cm - 4 legs, table top in 3 parts (2x131, 1x299 cm)

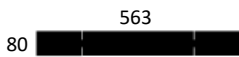

HPL laminate	5.539	5.737
Fenix laminate	6.151	6.237
Linoleum	5.849	6.054
Veneer*	6.434	6.529

### G69180 - 599x80xH73,5 cm - 3 legs, table top in 2 parts (2x299 cm)

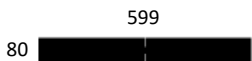

HPL laminate	4.841	5.144
Fenix laminate	5.471	5.753
Linoleum	5.229	5.498
Veneer*	5.427	5.498

### Surcharge

G69900 - GRIP leg	447	492
G69500 - GRIP linking device		120

\*Please note deviation in colour and grain may occur and we cannot recommend linking veneer tables. Other finishes and colours are available upon request, please contact our sales office.

Choice of other colours: Formica Colors and Forbo Linoleum + 10%

### Frame colour

\*\*Lacquered



Dark  
Petrol



Dusty  
Green



Sandy  
Grey



Dusty  
Olive



Terra-  
cotta



Warm  
Charcoal

### PRODUCT HIGHLIGHTS

- Modular construction - the table can be expanded and linked
- Removable legs, allows you to adjust positioning to meet individual needs
- Media integration is available - Grip powerbox
- Extremely stable frame construction
- Up to 3m span between the legs



## GRIP MEETING - TABLES

Design: Troels Grum-Schwensen

Frame	Frame black Lacquered**	Frame colour Lacquered**
Edge	Edge profile chamfered lacquered	

### G69200 - 131x108xH74,5 cm - 2 legs

131  
108

HPL laminate	2.220	2.263
Fenix laminate	2.412	2.454
Linoleum	2.347	2.392
Veneer*	2.583	2.631

### G69210 - 179x108xH74,5 cm, 2 legs

179  
108

HPL laminate	2.386	2.429
Fenix laminate	2.783	2.825
Linoleum	2.502	2.546
Veneer*	2.753	2.800

### G69220 - 239x108xH74,5 cm - 2 legs

239  
108

HPL laminate	2.795	2.951
Fenix laminate	3.146	3.253
Linoleum	2.949	3.142
Veneer*	3.244	3.292

### G69230 - 299x108xH74,5 cm - 2 legs

299  
108

HPL laminate	3.329	3.439
Fenix laminate	3.642	3.869
Linoleum	3.495	3.678
Veneer*	3.734	3.781

### Surcharge

G69900 - GRIP leg	447	492
G69500 - GRIP linking device		120

\*Please note deviation in colour and grain may occur and we cannot recommend linking veneer tables. Other finishes and colours are available upon request, please contact our sales office.

Choice of other colours: Formica Colors and Forbo Linoleum + 10%

### Frame colour

\*\*Lacquered



Dark  
Petrol



Dusty  
Green



Sandy  
Grey



Dusty  
Olive



Terra-  
cotta



Warm  
Charcoal

### PRODUCT HIGHLIGHTS

- Modular construction - the table can be expanded and linked
- Removable legs, allows you to adjust positioning to meet individual needs
- Media integration is available - Grip powerbox
- Extremely stable frame construction
- Up to 3m span between the legs



## GRIP MEETING - TABLES

Design: Troels Grum-Schwensen

Frame	Frame black Lacquered**	Frame colour Lacquered**
Edge	Edge profile chamfered lacquered	

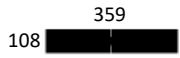

### G69240 - 359x108xH74,5 cm - 3 legs, table top in 2 parts (2x179 cm)

HPL laminate	4.441	4.505
Fenix laminate	4.973	5.037
Linoleum	4.673	4.737
Veneer*	5.139	5.210

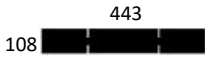

### G69250 - 443x108xH74,5 cm - 4 legs, table top in 3 parts (2x131, 1x179 cm)

HPL laminate	6.159	6.246
Fenix laminate	6.810	6.897
Linoleum	6.534	6.620
Veneer*	7.186	7.281

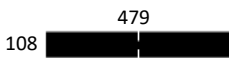

### G69260 - 479x108xH74,5 cm - 3 legs, table top in 2 parts (2x239 cm)

HPL laminate	5.258	5.536
Fenix laminate	5.961	6.146
Linoleum	5.564	5.912
Veneer*	6.122	6.193

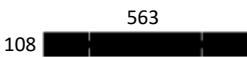

### G69270 - 563x108xH74,5 cm - 4 legs, table top in 3 parts (2x131, 1x299 cm)

HPL laminate	6.973	7.059
Fenix laminate	7.800	7.886
Linoleum	7.424	7.510
Veneer*	8.166	8.261

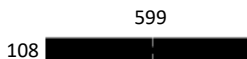

### G69280 - 599x108xH74,5 cm - 3 legs, table top in 2 parts (2x299 cm)

HPL laminate	6.312	6.502
Fenix laminate	7.020	7.368
Linoleum	6.714	7.042
Veneer*	7.102	7.173

#### Surcharge

G69900 - GRIP leg	447	492
G69500 - GRIP linking device		120

\*Please note deviation in colour and grain may occur and we cannot recommend linking veneer tables. Other finishes and colours are available upon request, please contact our sales office.

Choice of other colours: Formica Colors and Forbo Linoleum + 10%

#### Frame colour

\*\*Lacquered



Dark  
Petrol



Dusty  
Green



Sandy  
Grey



Dusty  
Olive



Terra-  
cotta



Warm  
Charcoal

#### PRODUCT HIGHLIGHTS

- Modular construction - the table can be expanded and linked
- Removable legs, allows you to adjust positioning to meet individual needs
- Media integration is available - Grip powerbox
- Extremely stable frame construction
- Up to 3m span between the legs



## GRIP WOOD - TABLES

Design: Troels Grum-Schwensen

Frame	Frame black Lacquered**	Frame colour Lacquered**
Edge	Edge profile chamfered	
<b>G69310 - 179x100xH74 cm - 2 legs</b>		
Oak/White oil*	<b>3.912</b>	<b>4.034</b>
<b>G69320 - 239x100xH74 cm - 2 legs</b>		
Oak/White oil*	<b>4.724</b>	<b>4.768</b>
<b>Surcharge</b>		
G69900 - GRIP leg	<b>447</b>	<b>492</b>

100  179

100  239

\*Please note deviation in colour and grain may occur and we cannot recommend linking the tables.  
Other finishes and colours are available upon request, please contact our sales office.  
Choice of other colours: Formica Colors and Forbo Linoleum + 10%

### Frame colour

\*\*Lacquered



Dark  
Petrol



Dusty  
Green



Sandy  
Grey



Dusty  
Olive



Terra-  
cotta



Warm  
Charcoal

### PRODUCT HIGHLIGHTS

- Tabletop in solid wood
- Removable legs, allows you to adjust positioning to meet individual needs
- Extremely stable frame construction
- Up to 3 m span between the legs

## GRIP POWERBOX

---

### PBOXL-MODA-xx

1xHDMI 2.0, 1xPDS Cat6 UTP, 1xUSB charger A+C, 1 xUSB charger C+C, 3x230V Schuko (Incl. Cut-out and lid)

450 x 50 x 52 mm

**1.134**

### G69550

Cut-out incl. alu-lid, excl. powerbox

**425**

---

Powerbox only available for GRIP Basic and GRIP Meeting

### PRODUCT HIGHLIGHTS

- Only available on Grip Basic and Grip Meeting
- With aluminum lid
- Can be equipped individually
- With 3 m. cable



## LINK - TABLES

Design: Hans-Thyge & Co.

### TABLE TOP - LINOLEUM



Black (Nero)  
4023



Ash  
4132



Mushrom  
4176

### LEGS / RAIL / EDGE



Oak  
White pigm.matt lacq.



Oak  
Black matt lacquer

### METAL ON LEG CONSTRUCTION



Black  
RAL 9005





## LINK - TABLES

Design: Hans-Thyge & Co.



Frame	Frame Oak/White pigm. matt lacquer	Frame Oak/Black matt lacquer
-------	---------------------------------------	---------------------------------

### L120070

Table top 70x120xH73,5 cm - no legs

Linoleum\*

Oak edge - whitepigm. matt lacquer

1.149

Oak edge - black matt lacquer

1.149

### L120140

140x120xH73,5 cm - 2 pair of legs

Linoleum\*

Oak edge - whitepigm. matt lacquer

2.590

Oak edge - black matt lacquer

2.590

### L120145

145x120xH73,5 cm - 2 pair of legs

Linoleum\*

Oak edge - whitepigm. matt lacquer

2.736

Oak edge - black matt lacquer

2.736

### L120200

200x120xH73,5 cm - 2 pair of legs

Linoleum\*

Oak edge - whitepigm. matt lacquer

2.902

Oak edge - black matt lacquer

2.902

### L120120

120x120xH73,5 cm - diagonal dimensions 130 cm - with fixed legs

Linoleum\*

Oak edge - whitepigm. matt lacquer

2.046

Oak edge - black matt lacquer

2.046

Other Linoleum colours are available upon request, please contact our sales office.

### Table top

\*Linoleum

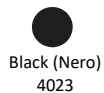

### PRODUCT HIGHLIGHTS

- Large range of modules
- User-friendly linking system
- Solid wooden beam and legs
- Edge in solid oak
- Knock down construction, flat packed
- High stability
- Moveable and flexible leg position



## LINK - TABLES

Design: Hans-Thyge & Co.



Frame	Frame Oak/White pigm. matt lacquer	Frame Oak/Black matt lacquer
-------	---------------------------------------	---------------------------------

### L120280

**280x120xH73,5 cm - 3 pair of legs, table top in 2 parts (2x140 cm)**

Linoleum\*

Oak edge - whitepigm. matt lacquer

**4.761**

Oak edge - black matt lacquer

**4.761**



### L120340

**340x120xH73,5 cm - 3 pair of legs, table top in 2 parts (140+200 cm)**

Linoleum\*

Oak edge - whitepigm. matt lacquer

**5.075**

Oak edge - black matt lacquer

**5.075**



### L120350

**350x120xH73,5 cm - 4 pair of legs, table top in 3 parts (140+70+140 cm)**

Linoleum\*

Oak edge - whitepigm. matt lacquer

**6.410**

Oak edge - black matt lacquer

**6.410**



### L120400

**400x120xH73,5 cm - 3 pair of legs, table top in 2 parts (2x200 cm)**

Linoleum\*

Oak edge - whitepigm. matt lacquer

**5.386**

Oak edge - black matt lacquer

**5.386**



### L120480

**480x120xH73,5 cm - 4 pair of legs, table top in 3 parts (140+200+140 cm)**

Linoleum\*

Oak edge - whitepigm. matt lacquer

**7.246**

Oak edge - black matt lacquer

**7.246**

Other Linoleum colours are available upon request, please contact our sales office.

### Table top

\*Linoleum



Black (Nero)  
4023



Ash  
4132



Mushrom  
4176

### PRODUCT HIGHLIGHTS

- Large range of modules
- User-friendly linking system
- Solid wooden beam and legs
- Edge in solid oak
- Knock down construction, flat packed
- High stability
- Moveable and flexible leg position



## LINK - TABLES

Design: Hans-Thyge & Co.



Frame	Frame Oak/White pigm. matt lacquer	Frame Oak/Black matt lacquer
-------	---------------------------------------	---------------------------------

### L120285

285x120xH73,5 cm - 3 pair of legs, table top in 2 parts (140+145 cm)

Linoleum\*

Oak edge - whitepigm. matt lacquer

4.907

Oak edge - black matt lacquer

4.907



### L120290

290x120xH73,5 cm - 3 legs, table top in 2 parts (2x145 cm)

Linoleum\*

Oak edge - whitepigm. matt lacquer

5.053

Oak edge - black matt lacquer

5.053



### L120360

360x120xH73,5 cm - 4 legs, table top in 3 parts (145+70+145 cm)

Linoleum\*

Oak edge - whitepigm. matt lacquer

6.703

Oak edge - black matt lacquer

6.703

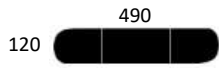

### L120490

490x120xH73,5 cm - 4 legs, table top in 3 parts (140+200+140 cm)

Linoleum\*

Oak edge - whitepigm. matt lacquer

7.537

Oak edge - black matt lacquer

7.537

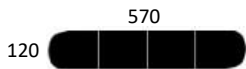

### L120570

570x120xH73,5 cm - 5 pair of legs, table top in 4 parts (145+2x140+145 cm)

Linoleum\*

Oak edge - whitepigm. matt lacquer

9.397

Oak edge - black matt lacquer

9.397

Other Linoleum colours are available upon request, please contact our sales office.

#### Table top

\*Linoleum

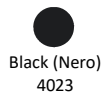

#### PRODUCT HIGHLIGHTS

- Large range of modules
- User-friendly linking system
- Solid wooden beam and legs
- Edge in solid oak
- Knock down construction, flat packed
- High stability
- Moveable and flexible leg position



## LINK - TABLES

Design: Hans-Thyge & Co.

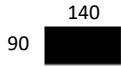

Frame	Frame Oak/White pigm. matt lacquer	Frame Oak/Black matt lacquer
-------	---------------------------------------	---------------------------------

**L090140**  
**140x90xH73,5 cm - 2 pair of legs**  
**Linoleum\***

Oak edge - whitepigm. matt lacquer	<b>2.171</b>	
Oak edge - black matt lacquer		<b>2.171</b>

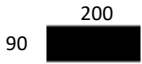

**L090200**  
**200x90xH73,5 cm - 2 pair of legs**  
**Linoleum\***

Oak edge - whitepigm. matt lacquer	<b>2.590</b>	
Oak edge - black matt lacquer		<b>2.590</b>



**L090280**  
**280x90xH73,5 cm - 3 pair of legs, table top in 2 parts (2x140 cm)**  
**Linoleum\***

Oak edge - whitepigm. matt lacquer	<b>3.925</b>	
Oak edge - black matt lacquer		<b>3.925</b>

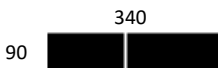

**L090340**  
**340x90xH73,5 cm - 3 pair of legs, table top in 2 parts (140+200 cm)**  
**Linoleum\***

Oak edge - whitepigm. matt lacquer	<b>4.342</b>	
Oak edge - black matt lacquer		<b>4.342</b>



**L090400**  
**400x90xH73,5 cm - 3 pair of legs, table top in 2 parts (2x200 cm)**  
**Linoleum\***

Oak edge - whitepigm. matt lacquer	<b>4.761</b>	
Oak edge - black matt lacquer		<b>4.761</b>

Other Linoleum colours are available upon request, please contact our sales office.

### Table top

\*Linoleum

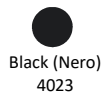

### PRODUCT HIGHLIGHTS

- Large range of modules
- User-friendly linking system
- Solid wooden beam and legs
- Edge in solid oak
- Knock down construction, flat packed
- High stability
- Moveable and flexible leg position



## LINK BAR - HIGH TABLES

Design: Hans-Thyge & Co.

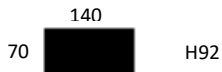

Frame

Frame  
Oak/White pigm. matt lacquer

Frame  
Oak/Black matt lacquer

### LC070140

140x70xH92 cm - 2 pair of legs

Oak edge - whitepigm. matt lacquer  
Oak edge - black matt lacquer

2.349

2.349

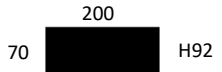

### LC070200

200x70xH92 cm - 2 pair of legs

Oak edge - whitepigm. matt lacquer  
Oak edge - black matt lacquer

2.485

2.485

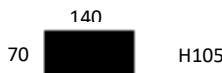

### LB070140

140x70xH105 cm - 2 pair of legs

Oak edge - whitepigm. matt lacquer  
Oak edge - black matt lacquer

2.432

2.432

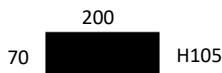

### LB070200

200x70xH105 cm - 2 pair of legs

Oak edge - whitepigm. matt lacquer  
Oak edge - black matt lacquer

2.568

2.568

Other Linoleum colours are available upon request, please contact our sales office.

#### Table top



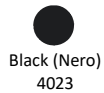







\*Linoleum

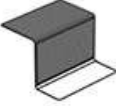

#### PRODUCT HIGHLIGHTS

- Bar table
- Solid wooden beam and legs
- Edge in solid oak
- High stability

## LINK FEATURES / ACCESSORIES

	Price
	<b>LGVL</b> <b>Pair of legs</b>
	Oak/White pigmented matt lacquer <b>459</b>
	Oak/Black matt lacquer <b>459</b>
	<b>L-TSKUF</b> <b>Solid oak drawer</b>
	Oak/White pigmented matt lacquer <b>386</b>
	Oak/Black matt lacquer <b>386</b>
	<b>L-IMPULT</b> <b>Standing desk</b>
	Black <b>314</b>
	<b>L-MBAK</b> <b>Metal tray</b>
	Black <b>125</b>
	<b>L-KOBL</b> <b>Linking device (set)</b>
	Black <b>42</b>
	<b>L-PBOXR1</b> <b>Frame for powerbox, single (incl. cut-out and lid)</b>
	Black <b>344</b>
	<b>L-PBOXR2</b> <b>Frame for powerbox, double (incl. cut-out and lid)</b>
	Black <b>642</b>
	<b>L-PBOXA</b> <b>Powerbox, 3 x 230 V incl. 3 m. cord</b>
	Black <b>137</b>
	<b>L-PBOXB</b> <b>Powerbox, 2 x 230 V, 2 x HDMI 2.0 incl. 3 m. cord</b>
	Black <b>205</b>
	<b>L-PBOXC</b> <b>Powerbox, 2 x 230 V, 2 x Cat 6A incl. 3 m. cord</b>
	Black <b>214</b>
	<b>L-PBOXD</b> <b>Powerbox, 2 x 230 V, 1 x USB A+C, 22 W incl. 3 m. cord</b>
	Black <b>419</b>
	<b>L-PBOXE</b> <b>Powerbox, 2 x 230 V, 1 x USB C, 30 W incl. 3 m. cord</b>
	Black <b>392</b>



# SPACE - TABLES

Design: Andersen Design Team

## TABLE TOP - LAMINATE (HPL)



White (Alpino)  
K1040



Kashmir  
F0187



Cafe  
F0903



Terril  
F2297



Diamond Black  
F2253



Ocean Grey  
F7853



Pumice  
F7858



Silver  
F2791



Iron  
F7902



Pale Olive  
F3007



Artic Blue  
F5493



Lead  
F7924



Mouse  
F7928

## TABLE TOP - FENIX LAMINATE



Black (Nero Ingo)  
0720



Bianco Male  
0029



Beige Luxor  
0719



Beige Arizona  
0748



Castoro Ottawa  
0717



Cacao Orinoco  
0749



Grigio Efeso  
0725



Grigio Antrim  
0752



Grigio Londra  
0718



Grigio Bromo  
0724



Rosso Jaipur  
0751



Verde Comodoro  
0750



Blu Fes  
0754

## TABLE TOP - LINOLEUM



Black (Nero)  
4023



Ash  
4132



Burgundy  
4154



Maive  
4172



Mushrom  
4176



Olive  
4184



Pebble  
4175



Pewter  
4155



Pistachio  
4183



Smokey Blue  
4179



Vapour  
4177



Charcoal  
4166



Conifer  
4174

## TABLE TOP - OAK VENEER



Oak

Whitepig. matt lacquer



Oak

Clear matt lacquer

## LEGS / SUPPORTING FRAME



Oak

Whitepig. matt lacquer



Oak

Clear matt lacquer



Oak

Black lacquer



Oak

Smoked matt lacquer

## SPACE - TABLES

Design: Andersen Design Team

Table top	White Laminate (HPL)	Coloured Laminate (HPL)	Black Fenix Laminate*	Black Linoleum**	Oak veneer Lacquer
Edge	Edge blackpainted***	Edge blackpainted***	Edge blackpainted***	Edge blackpainted***	Edge banding in oak veneer

**Legs in oak - choose between: Whitepigmented matt lacquer / Clear matt lacquer / Black matt lacquer / Smoked matt lacquer**

### Width 90 cm

0-7403-	180x90xH74 cm	1.946	2.086	2.364	2.364	2.644
0-7405-	220x90xH74 cm	2.086	2.225	2.505	2.505	2.783

### Width 120 cm

0-7505-	220x120xH74 cm	2.225	2.364	2.644	2.644	2.924
0-7507-	240x120xH74 cm	2.364	2.505	2.783	2.783	3.063
0-7509-	295x120xH74 cm	2.505	2.644	2.924	2.924	3.202
0-7513-	360x120xH74 cm	2 table tops / 3 legs	3.620	3.900	4.319	4.737
0-7517-	420x120xH74 cm	2 table tops / 3 legs	4.876	5.295	5.714	6.271
0-7519-	480x120xH74 cm	2 table tops / 4 legs	5.017	5.429	5.854	6.412

### Width 140 cm

0-7613-	360x140xH74 cm	3 table tops / 3 legs	4.180	4.458	4.876	5.436
0-7617-	420x140xH74 cm	4 table tops / 3 legs	5.436	5.714	6.132	6.692
0-7619-	480x140xH74 cm	4 table tops / 4 legs	5.575	5.854	6.412	7.108

### Width 160 cm

0-7713-	360x160xH74 cm	3 table tops / 3 legs	4.598	5.017	5.854	6.412
0-7717-	420x160xH74 cm	4 table tops / 3 legs	5.854	6.551	7.668	8.505
0-7719-	480x160xH74 cm	4 table tops / 4 legs	5.993	6.692	7.946	8.783

### Round tables

0-7815-	Ø90xH74 cm	3 legs	1.388	1.529	1.668	1.807
0-7817-	Ø110xH74 cm	4 legs	1.668	1.807	1.946	2.086
0-7820-	Ø120xH74 cm	4 legs	1.807	1.946	2.086	2.364
0-7830-	Ø140xH74 cm	2 pieces/4 legs	2.505	2.644	2.783	3.063

### Surcharge

\* Additional fee for other Fenix laminate colours than black: 15%

\*\* Additional fee for other linoleum colours than black: 15%

\*\*\* Additional fee for oak veneer edge banding or edge painted in colour as laminate: 10%

### PRODUCT HIGHLIGHTS

- Possibility of cable cover - please see at page 82

# SPACE - TABLES

Design: Andersen Design Team

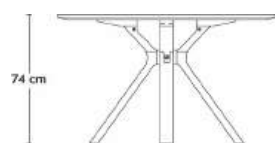
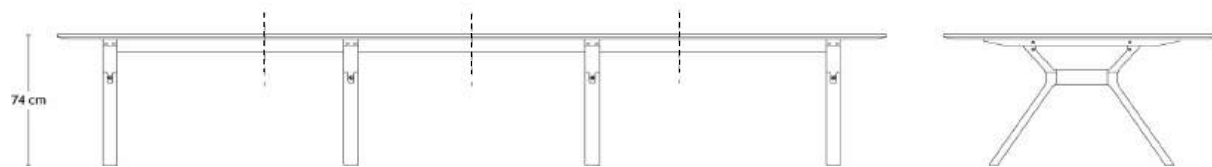
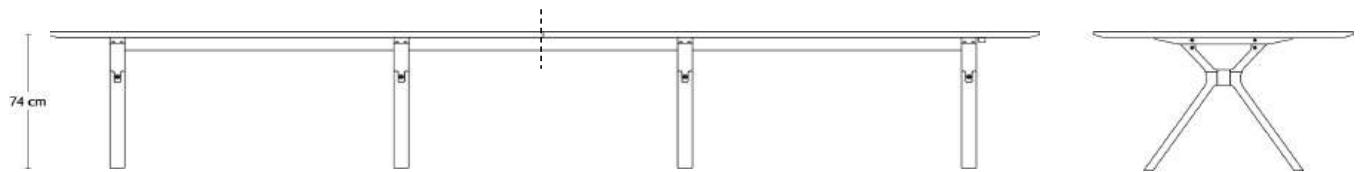
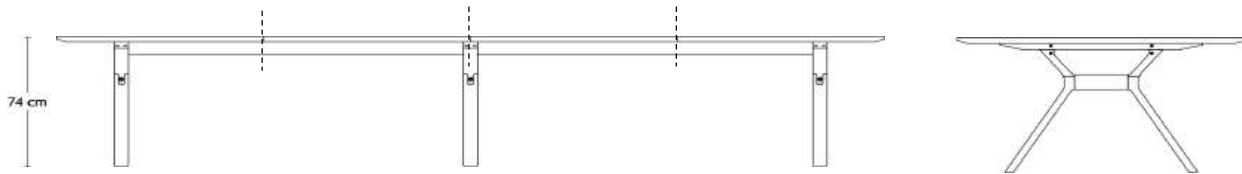
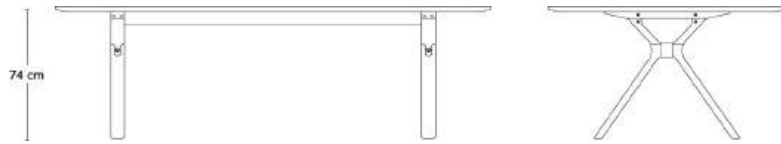

## SPACE - HIGH TABLES

Design: Andersen Design Team

Table top	White Laminate (HPL)	Coloured Laminate (HPL)	Black Fenix Laminate*	Black Linoleum**	Oak veneer Lacquer
Edge	Edge blackpainted***	Edge blackpainted***	Edge blackpainted***	Edge blackpainted***	Edge banding in oak veneer

**Legs in oak - choose between: Whitepigmented matt lacquer / Clear matt lacquer / Black matt lacquer / Smoked matt lacquer**

### Height 93 cm

0-70112-	160x70xH93 cm	1.946	2.086	2.364	2.364	2.644
0-70122-	160x80xH93 cm	1.946	2.086	2.364	2.364	2.644
0-70152-	220x70xH93 cm	2.086	2.225	2.505	2.505	2.783
0-70162-	220x80xH93 cm	2.086	2.225	2.505	2.505	2.783
0-70212-	275x70xH93 cm	2.225	2.364	2.644	2.644	2.924
0-70222-	275x80xH93 cm	2.225	2.364	2.644	2.644	2.924
0-71102-	Ø75xH93 cm	1.388	1.529	1.544	1.544	1.668
0-71402-	Ø90xH93 cm	1.529	1.668	1.685	1.685	1.807

### Height 108 cm

0-70111-	160x70xH108 cm	1.946	2.086	2.364	2.364	2.644
0-70121-	160x80xH108 cm	1.946	2.086	2.364	2.364	2.644
0-70151-	220x70xH108 cm	2.086	2.225	2.505	2.505	2.783
0-70161-	220x80xH108 cm	2.086	2.225	2.505	2.505	2.783
0-70211-	275x70xH108 cm	2.225	2.364	2.644	2.644	2.924
0-70221-	275x80xH108 cm	2.225	2.364	2.644	2.644	2.924
0-71101-	Ø75xH108 cm	1.388	1.529	1.544	1.544	1.668
0-71401-	Ø90xH108 cm	1.529	1.668	1.685	1.685	1.807

### Surcharge

\* Additional fee for other Fenix laminate colours than black: 15%

\*\* Additional fee for other linoleum colours than black: 15%

\*\*\* Additional fee for oak veneer edge banding or edge painted in colour as laminate: 10%

### PRODUCT HIGHLIGHTS

- Possibility of cable cover - please see at page 82

# SPACE FLIP - TABLES

Design: Andersen Design Team

Table top	White Laminate (HPL)	Coloured Laminate (HPL)	Black Fenix Laminate*	Black Linoleum**	Oak veneer Lacquer
Edge	ABS Edge***	ABS Edge***	ABS Edge***	ABS Edge***	Edge banding in oak veneer

**Legs in oak - choose between: Whitepigmented matt lacquer / Clear matt lacquer / Black matt lacquer / Smoked matt lacquer**

## Height 74 cm

2-3061-	160x80xH74 cm	1.744	1.883	2.163	2.163	2.442
2-3062-	180x90xH74 cm	1.827	1.966	2.246	2.246	2.525

## Surcharge

\* Additional fee for other Fenix laminate colours than black: 15%

\*\* Additional fee for other linoleum colours than black: 15%

\*\*\* Additional fee for oak veneer edge banding or edge painted in colour as laminate: 10%

## PRODUCT HIGHLIGHTS

- Tabletop available in a variety of materials and colors
- Simple, Scandinavian design and aesthetic
- Option for integrated cable covers and power solutions
- Designed with easy-to-use handles and locking mechanisms
- Option for practical storage
- Mounted on casters for dynamic use



Model 2-3061A-

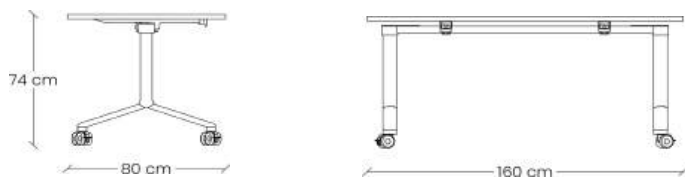

Model 2-3062A-

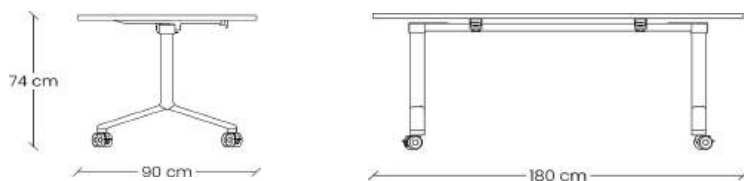



## SPACE - EXTENDABLE TABLES

Design: Andersen Design Team



Tabletop	White laminate Alpino K1040	Fenix laminate Castoro Ottawa 0717	Fenix laminate Verde Comodoro 0750
Edge	Edge blackpainted *	Edge painted as Fenix laminate *	Edge painted as Fenix laminate *

### 0-7903- 95x220xH74 cm

Extension for 4 leaves

Legs: Oak - Matt Lacquer:

(Whitepig. / Clear / Black / Smoked)

**2.047**

**2.410**

**2.410**

	White laminate Alpino K1040	Fenix laminate Castoro Ottawa 0717	Fenix laminate Verde Comodoro 0750
--	-----------------------------------	--	--

### Leaf

0-7913- 50x95 cm

**320**

**453**

**453**

### Surcharge

\* Additional fee for oak veneer edge banding: 10%

### Tabletop



Alpino



Castoro Ottawa



Verde Comodoro

### PRODUCT HIGHLIGHTS

- W 62 kg / CBM 0,4

Model 0-7903

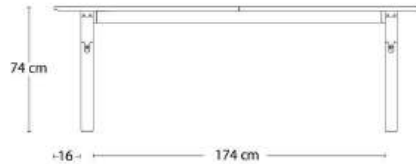



# SPACE ADD - TABLE

Design: Andersen Design Team

Tabletop

Cashmere Grey  
Soft-touch  
Laminate

Edge

ABS Edge  
Oak

**7-4110- 220x95xH74 cm**

Prepared for 2 leaves

Legs: Oak - Matt Lacquer:  
(Whitepig. / Clear)

**2.168**

Cashmere Grey  
Soft-touch  
Laminate

**Leaves**

7-4120- 50x95 cm 2 pcs.

**846**



**Tabletop**



## PRODUCT HIGHLIGHTS

- W 54 kg / CBM 0,3

Model 7-4110-

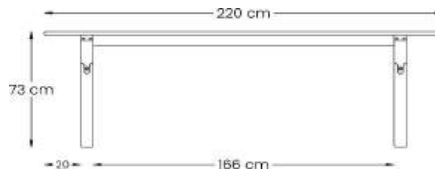



# TUBE - TABLES

Design: Randers+Radius

## TABLE TOP - LAMINATE (DECOR)



Light Grey

## TABLE TOP - LAMINATE (HPL)



White  
NCS S500-N



Light Grey  
F7961

## TABLE TOP - FENIX LAMINATE



Black (Nero Ingo)  
0720



Grigio Londra  
0718

## TABLE TOP - LINOLEUM



Black (Nero)  
4023

## FRAME COLOURS - GROUP 1



Black  
RAL 9005

## FRAME COLOURS - GROUP 2



Chrome

# TUBE - COLLECTION

Design: Randers+Radius

## TUBE BASIC

Folding table with release arm and open aluminium beam.  
Height 73 cm



Round corner

Square corner

## TUBE FOLD

Folding table with release button and closed aluminium beam. Height 73 cm



Round corner

Square corner

## TUBE WOOD

Folding table with release button and closed aluminium beam. Height 73 cm



## TUBE STAY

Not foldable - fixed table with open aluminium beam. Height 73 cm



Round corner

Square corner

## TUBE COUNTER

Folding table with release button and closed aluminium beam. Height 90 cm



Round corner

Square corner



Round corner.  
Round tube profile



Square corner.  
90° tube profile



**Tube Wood**  
Black frame w/wooden legs



**Tube Fold, Tube Counter & Tube Wood**  
Release button and closed aluminium beam



**Tube Basic**  
Open aluminium beam w/release arm



Stacking buffers

# TUBE - COLLECTION

Design: Randers+Radius

TABLETOP		FOLDING TABLES TUBE FOLD		FOLDING TABLES TUBE COUNTER		
		BLACK	CHROME	BLACK	CHROME	SATIN CHROME
LENGTH	WIDTH					
140	60	•	•	•	•	+
180	60	•	•	•	•	+
120	70	•	•			
140	70	•	•			
160	70	•	•			
180	70	•	•			
80	80	•	•			
120	80	•	•			
140	80	•	•			
160	80	•	•			
180	80	•	•			
180	90	•	•			
	Ø110	•	•			
	Ø120	•	•			

TABLETOP		FOLDING TABLES TUBE WOOD	
		OAK - WHITEPIGM. MATT LACQ.	OAK - BLACK MATT LACQUER
LENGTH	WIDTH		
80	80	•	•
120	80	•	•
140	80	•	•
160	80	•	•
180	80	•	•
180	90		
	Ø110	•	•
	Ø120	•	•

TABLETOP		NON-FOLDING TABLES TUBE FOLD	
		BLACK	CHROME
LENGTH	WIDTH		
120	70	•	•
140	70	•	•
160	70	•	•
180	70	•	•
80	80	•	•
120	80	•	•
140	80	•	•
160	80	•	•
180	80	•	•
180	90		
	Ø110	•	•
	Ø120	•	•

- Standard

# TUBE - WEIGHT OVERVIEW

Design: Randers+Radius

TABLETOP		FOLDING TABLES								NON FOLDING	
		TUBE BASIC		TUBE FOLD		TUBE WOOD	TUBE COUNTER		TUBE STAY		
LENGTH	WIDTH	Round TBR	Square TBS	Round TFR	Square TFS	TW	Round TCR	Square TCS	Round TSR	Square TSS	
140	60	22,5	23,5	22,7	23,6		23,7	24,7			
180	60	26,7	27,7	27,3	28,2		28,3	29,3			
120	70	22,6	23,5	22,5	23,5				20,8	21,7	
140	70	25,0	25,9	25,1	26,1				23,1	24,1	
160	70	27,4	28,3	27,7	28,6				25,5	26,5	
180	70	29,7	30,7	30,3	31,2				27,9	28,8	
80	80	19,3	20,2	18,9	19,8	18,74			17,8	18,7	
120	80	24,6	25,6	24,5	25,5	24,41			23,1	24,1	
140	80	27,3	28,2	27,4	28,4	27,28			25,8	26,7	
160	80	30,0	30,9	30,3	31,2	30,15			28,5	29,4	
180	80	32,6	33,6	33,2	34,1	33,03			31,1	32,1	
180	90	35,5	36,5	36,1	37,0						
	Ø110	23,8	24,7	23,4	24,3	23,27			22,3	23,2	
	Ø120	26,4	27,4	26,0	27,0	25,90			24,9	25,9	

The listed weights are based on a 19 mm top with HPL laminate / Fenix laminate and ABS edge. The weights are indicative.

Weights in kilograms to be added for other finishes:

- Linoleum with ABS edge, ca. 0,4 kg/ m<sup>2</sup>
- HPL laminate or Fenix laminate with plywood, ca. 0,5 kg/ m<sup>2</sup>
- Linoleum with plywood, ca: 0,9 kg/ m<sup>2</sup>

Light weight tops are available upon request, the weight reduction is approx. 5 kg / m<sup>2</sup>

## TUBE BASIC - TABLES

Design: Randers+Radius

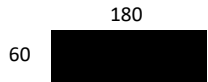
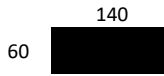

Tabletop	ABS edge				Plywood edge		
	Decor Laminate	HPL Laminate	Fenix Laminate	Linoleum*	HPL Laminate	Fenix Laminate	Linoleum*

### TB6140- 140x60xH73 cm

Frame colour (Grp. 1): Black - Corner: round / square

1-4 pcs.	842	919	1.014	1.044	1.056	1.202	1.139
<b>5+ pcs.</b>	<b>678</b>	<b>753</b>	<b>842</b>	<b>873</b>	<b>883</b>	<b>1.025</b>	<b>964</b>

Chair hanger: No

### TB6180- 180x60xH73 cm

Frame colour (Grp. 1): Black - Corner: round / square

1-4 pcs.	878	973	1.129	1.115	1.139	1.329	1.212
<b>5+ pcs.</b>	<b>712</b>	<b>803</b>	<b>954</b>	<b>942</b>	<b>964</b>	<b>1.147</b>	<b>1.036</b>

Chair hanger: No

\*Please treat linoleum surfaces with care when stacking in order to avoid scratches and pressure marks. We recommend vertical storage in our transport trolley - table top against table top.

Other sizes and finishes are available, please contact our sales office.

Choice of other colours - Formica Colors, Forbo Linoleum and Fenix laminate: 10% surcharge

### Surcharge

Frame surface in chrome (Grp. 2)	<b>53</b>
----------------------------------	-----------

### Frame colour

Grp. 1



Black

Grp. 2



Chrome

### PRODUCT HIGHLIGHTS

- Folding table
- Passed: EN15372
- Open aluminium beam
- Press the release button and the legs fold, can be managed by just one person
- High stability - extraordinary quality
- The table comes with 2 integrated casters and 4 stacking buffers
- Top thickness: 20mm
- Free space between the gables: width minus 12 cm



## TUBE BASIC - TABLES

Design: Randers+Radius

Tabletop	ABS edge				Plywood edge		
	Decor Laminate	HPL Laminate	Fenix Laminate	Linoleum*	HPL Laminate	Fenix Laminate	Linoleum*

### TB7120- 120x70xH73 cm

Frame colour (Grp. 1): Black - Corner: round / square

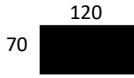

1-4 pcs.	829	903	1.020	1.031	1.034	1.181	1.142
<b>5+ pcs.</b>	<b>664</b>	<b>737</b>	<b>849</b>	<b>859</b>	<b>864</b>	<b>1.005</b>	<b>968</b>

Chair hanger: No

### TB7140- 140x70xH73 cm

Frame colour (Grp. 1): Black - Corner: round / square

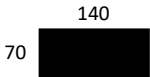

1-4 pcs.	851	932	1.076	1.073	1.083	1.254	1.186
<b>5+ pcs.</b>	<b>686</b>	<b>764</b>	<b>903</b>	<b>902</b>	<b>910</b>	<b>1.075</b>	<b>1.010</b>

Chair hanger: No

### TB7160- 160x70xH73 cm

Frame colour (Grp. 1): Black - Corner: round / square

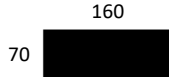

1-4 pcs.	878	978	1.115	1.122	1.136	1.331	1.234
<b>5+ pcs.</b>	<b>712</b>	<b>808</b>	<b>942</b>	<b>947</b>	<b>961</b>	<b>1.149</b>	<b>1.058</b>

Chair hanger: No

### TB7180- 180x70xH73 cm

Frame colour (Grp. 1): Black - Corner: round / square

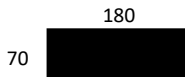

1-4 pcs.	888	1.003	1.176	1.154	1.173	1.392	1.264
<b>5+ pcs.</b>	<b>722</b>	<b>834</b>	<b>1.000</b>	<b>980</b>	<b>997</b>	<b>1.208</b>	<b>1.085</b>

Chair hanger: No

\*Please treat linoleum surfaces with care when stacking in order to avoid scratches and pressure marks. We recommend vertical storage in our transport trolley - table top against table top.

Other sizes and finishes are available, please contact our sales office.

Choice of other colours - Formica Colors, Forbo Linoleum and Fenix laminate: 10% surcharge

### Surcharge

Frame surface in chrome (Grp. 2)	<b>53</b>
----------------------------------	-----------

### Frame colour

Grp. 1



Black

Grp. 2



Chrome

### PRODUCT HIGHLIGHTS

- Folding table
- Passed: EN15372
- Open aluminium beam
- Press the release button and the legs fold, can be managed by just one person
- High stability - extraordinary quality
- The table comes with 2 integrated casters and 4 stacking buffers
- Top thickness: 20mm
- Free space between the gables: width minus 12 cm



## TUBE BASIC - TABLES

Design: Randers+Radius

Tabletop	ABS edge				Plywood edge		
	Decor Laminate	HPL Laminate	Fenix Laminate	Linoleum*	HPL Laminate	Fenix Laminate	Linoleum*

### TB8080- 80x80xH73 cm

Frame colour (Grp. 1): Black - Corner: round / square

1-4 pcs.	808	861	953	978	1.022	1.092	1.025
<b>5+ pcs.</b>	<b>646</b>	<b>697</b>	<b>785</b>	<b>808</b>	<b>851</b>	<b>919</b>	<b>854</b>

Chair hanger: Yes, 2 chairs (see overview on page 138)

### TB8120- 120x80xH73 cm

Frame colour (Grp. 1): Black - Corner: round / square

1-4 pcs.	837	925	1.053	1.058	1.066	1.234	1.195
<b>5+ pcs.</b>	<b>673</b>	<b>758</b>	<b>881</b>	<b>885</b>	<b>893</b>	<b>1.056</b>	<b>1.017</b>

Chair hanger: Yes, 4 chairs\*\* (see overview on page 138)

### TB8140- 140x80xH73 cm

Frame colour (Grp. 1): Black - Corner: round / square

1-4 pcs.	859	956	1.114	1.105	1.119	1.366	1.241
<b>5+ pcs.</b>	<b>695</b>	<b>788</b>	<b>941</b>	<b>932</b>	<b>944</b>	<b>1.185</b>	<b>1.063</b>

Chair hanger: Yes, 4 chairs (see overview on page 138)

### TB8160- 160x80xH73 cm

Frame colour (Grp. 1): Black - Corner: round / square

1-4 pcs.	886	1.002	1.202	1.156	1.175	1.397	1.288
<b>5+ pcs.</b>	<b>720</b>	<b>832</b>	<b>1.024</b>	<b>981</b>	<b>998</b>	<b>1.214</b>	<b>1.108</b>

Chair hanger: Yes, 4 chairs (see overview on page 138)

### TB8180- 180x80xH73 cm

Frame colour (Grp. 1): Black - Corner: round / square

1-4 pcs.	898	1.024	1.225	1.193	1.215	1.466	1.324
<b>5+ pcs.</b>	<b>732</b>	<b>854</b>	<b>1.047</b>	<b>1.017</b>	<b>1.037</b>	<b>1.280</b>	<b>1.142</b>

Chair hanger: Yes, 6 chairs (see overview on page 138)

\*Please treat linoleum surfaces with care when stacking in order to avoid scratches and pressure marks. We recommend vertical storage in our transport trolley - table top against table top.

\*\*Not enough space for 2 Dry chairs side by side

Other sizes and finishes are available, please contact our sales office.

Choice of other colours - Formica Colors, Forbo Linoleum and Fenix laminate: 10% surcharge

### Surcharge

Frame surface in chrome (Grp. 2)

**53**

### Frame colour

Grp. 1



Black

Grp. 2



Chrome

### PRODUCT HIGHLIGHTS

- Folding table
- Passed: EN15372
- Open aluminium beam
- Press the release button and the legs fold, can be managed by just one person
- Stacking height: only 7cm per table - also with chair hanger
- Available with chair hanger
- High stability - extraordinary quality
- The table comes with 2 integrated casters and 4 stacking buffers
- Top thickness: 20mm
- Free space between the gables: width minus 12 cm



## TUBE BASIC - TABLES

Design: Randers+Radius

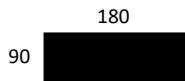

Tabletop	ABS edge				Plywood edge		
	Decor Laminate	HPL Laminate	Fenix Laminate	Linoleum*	HPL Laminate	Fenix Laminate	Linoleum*

### TB9180- 180x90xH73 cm

Frame colour (Grp. 1): Black - Corner: round / square

1-4 pcs.	934	1.088	1.332	1.290	1.275	1.554	1.398
<b>5+ pcs.</b>	<b>766</b>	<b>915</b>	<b>1.151</b>	<b>1.110</b>	<b>1.095</b>	<b>1.366</b>	<b>1.215</b>

Chair hanger: Yes, 6 chairs (see overview on page 138)

### TB0110- Ø110xH73 cm

Frame colour (Grp. 1): Black - Corner: round / square

1-4 pcs.	883	1.002	1.202	1.175	1.076	1.286	1.266
<b>5+ pcs.</b>	<b>717</b>	<b>832</b>	<b>1.025</b>	<b>998</b>	<b>903</b>	<b>1.107</b>	<b>1.086</b>

Chair hanger: No

### TB0120- Ø120xH73 cm

Frame colour (Grp. 1): Black - Corner: round / square

1-4 pcs.	900	1.051	1.219	1.231	1.122	1.371	1.324
<b>5+ pcs.</b>	<b>734</b>	<b>880</b>	<b>1.042</b>	<b>1.053</b>	<b>947</b>	<b>1.188</b>	<b>1.142</b>

Chair hanger: No

\*Please treat linoleum surfaces with care when stacking in order to avoid scratches and pressure marks. We recommend vertical storage in our transport trolley - table top against table top.

Other sizes and finishes are available, please contact our sales office.

Choice of other colours - Formica Colors, Forbo Linoleum and Fenix laminate: 10% surcharge

### Surcharge

Frame surface in chrome (Grp. 2)	<b>53</b>
----------------------------------	-----------

### Frame colour

Grp. 1



Black

Grp. 2



Chrome

### PRODUCT HIGHLIGHTS

- Folding table
- Passed: EN15372
- Open aluminium beam
- Press the release button and the legs fold, can be managed by just one person
- Stacking height: only 7cm per table - also with chair hanger
- Available with chair hanger
- High stability - extraordinary quality
- The table comes with 2 integrated casters and 4 stacking buffers
- Top thickness: 20mm
- Free space between the gables: width minus 12 cm



## TUBE FOLD - TABLES

Design: Randers+Radius

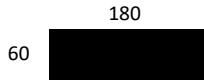
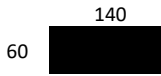

Tabletop	ABS edge				Plywood edge		
	Decor Laminate	HPL Laminate	Fenix Laminate	Linoleum*	HPL Laminate	Fenix Laminate	Linoleum*

### TF6140- 140x60xH73 cm

Frame colour (Grp. 1): Black - Corner: round / square

1-4 pcs.	907	981	1.076	1.107	1.119	1.266	1.203
<b>5+ pcs.</b>	<b>739</b>	<b>814</b>	<b>905</b>	<b>934</b>	<b>946</b>	<b>1.086</b>	<b>1.027</b>

Chair hanger: No

### TF6180- 180x60xH73 cm

Frame colour (Grp. 1): Black - Corner: round / square

1-4 pcs.	954	1.051	1.205	1.193	1.217	1.405	1.290
<b>5+ pcs.</b>	<b>786</b>	<b>880</b>	<b>1.029</b>	<b>1.017</b>	<b>1.039</b>	<b>1.222</b>	<b>1.110</b>

Chair hanger: No

\*Please treat linoleum surfaces with care when stacking in order to avoid scratches and pressure marks. We recommend vertical storage in our transport trolley - table top against table top.

Other sizes and finishes are available, please contact our sales office.

Choice of other colours - Formica Colors, Forbo Linoleum and Fenix laminate: 10% surcharge

### Surcharge

Frame surface in chrome (Grp. 2)

**53**

### Frame colour

Grp. 1



Black

Grp. 2



Chrome

### PRODUCT HIGHLIGHTS

- Folding table
- Passed: EN15372
- Closed aluminium beam
- Press the release button and the legs fold, can be managed by just one person
- Stacking height: only 7cm per table - also with chair hanger
- High stability - extraordinary quality
- The table comes with 2 integrated casters and 4 stacking buffers
- Top thickness: 20 mm
- Free space between the gables: width minus 12 cm



## TUBE FOLD - TABLES

Design: Randers+Radius

Tabletop	ABS edge				Plywood edge		
	Decor Laminate	HPL Laminate	Fenix Laminate	Linoleum*	HPL Laminate	Fenix Laminate	Linoleum*

### TF7120- 120x70xH73 cm

Frame colour (Grp. 1): Black - Corner: round / square

1-4 pcs.	892	966	1.083	1.093	1.098	1.244	1.207
<b>5+ pcs.</b>	<b>725</b>	<b>798</b>	<b>910</b>	<b>920</b>	<b>925</b>	<b>1.066</b>	<b>1.029</b>

Chair hanger: No

### TF7140- 140x70xH73 cm

Frame colour (Grp. 1): Black - Corner: round / square

1-4 pcs.	915	995	1.139	1.137	1.147	1.319	1.249
<b>5+ pcs.</b>	<b>747</b>	<b>825</b>	<b>964</b>	<b>963</b>	<b>971</b>	<b>1.137</b>	<b>1.071</b>

Chair hanger: No

### TF7160- 160x70xH73 cm

Frame colour (Grp. 1): Black - Corner: round / square

1-4 pcs.	941	1.041	1.180	1.185	1.198	1.393	1.297
<b>5+ pcs.</b>	<b>773</b>	<b>869</b>	<b>1.003</b>	<b>1.008</b>	<b>1.022</b>	<b>1.210</b>	<b>1.117</b>

Chair hanger: No

### TF7180- 180x70xH73 cm

Frame colour (Grp. 1): Black - Corner: round / square

1-4 pcs.	964	1.081	1.254	1.232	1.251	1.469	1.341
<b>5+ pcs.</b>	<b>797</b>	<b>908</b>	<b>1.075</b>	<b>1.054</b>	<b>1.071</b>	<b>1.283</b>	<b>1.159</b>

Chair hanger: No

\*Please treat linoleum surfaces with care when stacking in order to avoid scratches and pressure marks. We recommend vertical storage in our transport trolley - table top against table top.

Other sizes and finishes are available, please contact our sales office.

Choice of other colours - Formica Colors, Forbo Linoleum and Fenix laminate: 10% surcharge

### Surcharge

Frame surface in chrome (Grp. 2)	<b>53</b>
----------------------------------	-----------

### Frame colour

Grp. 1



Black

Grp. 2



Chrome

### PRODUCT HIGHLIGHTS

- Folding table
- Passed: EN15372
- Closed aluminium beam
- Press the release button and the legs fold, can be managed by just one person
- Stacking height: only 7cm per table - also with chair hanger
- High stability - extraordinary quality
- The table comes with 2 integrated casters and 4 stacking buffers
- Top thickness: 20 mm
- Free space between the gables: width minus 12 cm



## TUBE FOLD - TABLES

Design: Randers+Radius

Tabletop	ABS edge				Plywood edge		
	Decor Laminate	HPL Laminate	Fenix Laminate	Linoleum*	HPL Laminate	Fenix Laminate	Linoleum*

### TF8080- 80x80xH73 cm

Frame colour (Grp. 1): Black - Corner: round / square

1-4 pcs.	831	883	975	1.002	1.044	1.114	1.047
<b>5+ pcs.</b>	<b>668</b>	<b>717</b>	<b>807</b>	<b>831</b>	<b>873</b>	<b>941</b>	<b>876</b>

Chair hanger: Yes, 2 chairs (see overview on page 138)

### TF8120- 120x80xH73 cm

Frame colour (Grp. 1): Black - Corner: round / square

1-4 pcs.	900	988	1.115	1.120	1.129	1.297	1.258
<b>5+ pcs.</b>	<b>734</b>	<b>819</b>	<b>942</b>	<b>946</b>	<b>954</b>	<b>1.117</b>	<b>1.078</b>

Chair hanger: Yes, 4 chairs\*\* (see overview on page 138)

### TF8140- 140x80xH73 cm

Frame colour (Grp. 1): Black - Corner: round / square

1-4 pcs.	924	1.020	1.178	1.169	1.181	1.431	1.305
<b>5+ pcs.</b>	<b>756</b>	<b>849</b>	<b>1.002</b>	<b>993</b>	<b>1.005</b>	<b>1.246</b>	<b>1.124</b>

Chair hanger: Yes, 4 chairs (see overview on page 138)

### TF8160- 160x80xH73 cm

Frame colour (Grp. 1): Black - Corner: round / square

1-4 pcs.	949	1.064	1.264	1.220	1.237	1.461	1.351
<b>5+ pcs.</b>	<b>781</b>	<b>893</b>	<b>1.085</b>	<b>1.042</b>	<b>1.059</b>	<b>1.275</b>	<b>1.169</b>

Chair hanger: Yes, 4 chairs (see overview on page 138)

### TF8180- 180x80xH73 cm

Frame colour (Grp. 1): Black - Corner: round / square

1-4 pcs.	976	1.102	1.303	1.271	1.293	1.544	1.402
<b>5+ pcs.</b>	<b>807</b>	<b>929</b>	<b>1.124</b>	<b>1.092</b>	<b>1.114</b>	<b>1.354</b>	<b>1.217</b>

Chair hanger: Yes, 6 chairs (see overview on page 138)

\*Please treat linoleum surfaces with care when stacking in order to avoid scratches and pressure marks. We recommend vertical storage in our transport trolley - table top against table top.

\*\*Not enough space for 2 Dry chairs side by side

Other sizes and finishes are available, please contact our sales office.

Choice of other colours - Formica Colors, Forbo Linoleum and Fenix laminate: 10% surcharge

### Surcharge

Frame surface in chrome (Grp. 2)

**53**

### Frame colour

Grp. 1



Black

Grp. 2



Chrome

### PRODUCT HIGHLIGHTS

- Folding table
- Passed: EN15372
- Closed aluminium beam
- Press the release button and the legs fold, can be managed by just one person
- Stacking height: only 7cm per table - also with chair hanger
- Available with chair hanger
- High stability - extraordinary quality
- The table comes with 2 integrated casters and 4 stacking buffers
- Top thickness: 20 mm
- Free space between the gables: width minus 12 cm



## TUBE FOLD - TABLES

Design: Randers+Radius

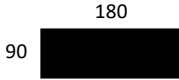

Tabletop	ABS edge				Plywood edge		
	Decor Laminate	HPL Laminate	Fenix Laminate	Linoleum*	HPL Laminate	Fenix Laminate	Linoleum*

### TF9180- 180x90xH73 cm

Frame colour (Grp. 1): Black - Corner: round / square

1-4 pcs.	986	1.141	1.385	1.342	1.327	1.607	1.451
<b>5+ pcs.</b>	<b>817</b>	<b>966</b>	<b>1.202</b>	<b>1.161</b>	<b>1.146</b>	<b>1.417</b>	<b>1.266</b>

Chair hanger: Yes, 6 chairs (see overview on page 138)

### TF0110- Ø110xH73 cm

Frame colour (Grp. 1): Black - Corner: round / square

1-4 pcs.	905	1.025	1.225	1.197	1.100	1.310	1.288
<b>5+ pcs.</b>	<b>739</b>	<b>854</b>	<b>1.047</b>	<b>1.020</b>	<b>925</b>	<b>1.129</b>	<b>1.108</b>

Chair hanger: No

### TF0120- Ø120xH73 cm

Frame colour (Grp. 1): Black - Corner: round / square

1-4 pcs.	922	1.073	1.242	1.254	1.144	1.395	1.346
<b>5+ pcs.</b>	<b>756</b>	<b>902</b>	<b>1.064</b>	<b>1.075</b>	<b>969</b>	<b>1.210</b>	<b>1.164</b>

Chair hanger: No

\*Please treat linoleum surfaces with care when stacking in order to avoid scratches and pressure marks. We recommend vertical storage in our transport trolley - table top against table top.

Other sizes and finishes are available, please contact our sales office.

Choice of other colours - Formica Colors, Forbo Linoleum and Fenix laminate: 10% surcharge

### Surcharge

Frame surface in chrome (Grp. 2)	<b>53</b>
----------------------------------	-----------

### Frame colour

Grp. 1



Black

Grp. 2



Chrome

### PRODUCT HIGHLIGHTS

- Folding table
- Passed: EN15372
- Closed aluminium beam
- Press the release button and the legs fold, can be managed by just one person
- Stacking height: only 7cm per table - also with chair hanger
- Available with chair hanger
- High stability - extraordinary quality
- The table comes with 2 integrated casters and 4 stacking buffers
- Top thickness: 20 mm
- Free space between the gables: width minus 12 cm



## TUBE WOOD - TABLES

Design: Randers+Radius

Tabletop	ABS edge				Plywood edge		
	Decor Laminate	HPL Laminate	Fenix Laminate	Linoleum*	HPL Laminate	Fenix Laminate	Linoleum*

### TW8080- 80x80xH73 cm

Frame colour: Black top frame with legs in oak  
(White pigm. matt lacquer / Black matt lacquer)

1-4 pcs.	968	1.019	1.110	1.137	1.180	1.249	1.183
<b>5+ pcs.</b>	<b>798</b>	<b>849</b>	<b>937</b>	<b>961</b>	<b>1.003</b>	<b>1.071</b>	<b>1.007</b>

Chair hanger: Yes, 2 chairs (see overview on page 138)

### TW8120- 120x80xH73 cm

Frame colour: Black top frame with legs in oak  
(White pigm. matt lacquer / Black matt lacquer)

1-4 pcs.	1.036	1.124	1.251	1.256	1.264	1.432	1.393
<b>5+ pcs.</b>	<b>864</b>	<b>949</b>	<b>1.073</b>	<b>1.076</b>	<b>1.086</b>	<b>1.247</b>	<b>1.210</b>

Chair hanger: Yes, 4 chairs\*\* (see overview on page 138)

### TW8140- 140x80xH73 cm

Frame colour: Black top frame with legs in oak  
(White pigm. matt lacquer / Black matt lacquer)

1-4 pcs.	1.059	1.156	1.314	1.305	1.317	1.566	1.441
<b>5+ pcs.</b>	<b>886</b>	<b>980</b>	<b>1.132</b>	<b>1.124</b>	<b>1.137</b>	<b>1.376</b>	<b>1.256</b>

Chair hanger: Yes, 4 chairs (see overview on page 138)

### TW8160- 160x80xH73 cm

Frame colour: Black top frame with legs in oak  
(White pigm. matt lacquer / Black matt lacquer)

1-4 pcs.	1.085	1.200	1.400	1.356	1.373	1.597	1.486
<b>5+ pcs.</b>	<b>914</b>	<b>1.024</b>	<b>1.215</b>	<b>1.173</b>	<b>1.190</b>	<b>1.405</b>	<b>1.300</b>

Chair hanger: Yes, 4 chairs (see overview on page 138)

### TW8180- 180x80xH73 cm

Frame colour: Black top frame with legs in oak  
(White pigm. matt lacquer / Black matt lacquer)

1-4 pcs.	1.112	1.237	1.439	1.407	1.429	1.680	1.537
<b>5+ pcs.</b>	<b>937</b>	<b>1.059</b>	<b>1.254</b>	<b>1.224</b>	<b>1.244</b>	<b>1.485</b>	<b>1.347</b>

Chair hanger: Yes, 6 chairs (see overview on page 138)

\*Please treat linoleum surfaces with care when stacking in order to avoid scratches and pressure marks. We recommend vertical storage in our transport trolley - table top against table top.

\*\*Not enough space for 2 Dry chairs side by side

Other sizes and finishes are available, please contact our sales office.

Choice of other colours - Formica Colors, Forbo Linoleum and Fenix laminate: 10% surcharge

### Frame colour

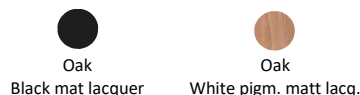

### PRODUCT HIGHLIGHTS

- Folding table: High stability - extraordinary quality
- Closed aluminium beam
- The table comes with 4 stacking buffers
- Solid wood legs
- Stacking height: only 7cm per table - also with chair hanger
- Free space between the gables: width minus 12 cm
- Press the release button and the legs fold, can be managed by just one person
- Passed: EN15372
- Available with chair hanger
- Top thickness: 20 mm



## TUBE WOOD - TABLES

Design: Randers+Radius

Tabletop	ABS edge				Plywood edge		
	Decor Laminate	HPL Laminate	Fenix Laminate	Linoleum*	HPL Laminate	Fenix Laminate	Linoleum*

### TW0110- Ø110xH73 cm

Frame colour: Black top frame with legs in oak  
(White pigm. matt lacquer / Black matt lacquer)

Ø110



1-4 pcs.	1.041	1.161	1.361	1.332	1.236	1.446	1.424
<b>5+ pcs.</b>	<b>869</b>	<b>985</b>	<b>1.178</b>	<b>1.153</b>	<b>1.058</b>	<b>1.259</b>	<b>1.239</b>

Chair hanger: No

### TW0120- Ø120xH73 cm

Frame colour: Black top frame with legs in oak  
(White pigm. matt lacquer / Black matt lacquer)

Ø120



1-4 pcs.	1.058	1.208	1.378	1.390	1.280	1.531	1.481
<b>5+ pcs.</b>	<b>886</b>	<b>1.032</b>	<b>1.195</b>	<b>1.207</b>	<b>1.100</b>	<b>1.342</b>	<b>1.295</b>

Chair hanger: No

\*Please treat linoleum surfaces with care when stacking in order to avoid scratches and pressure marks. We recommend vertical storage in our transport trolley - table top against table top.

\*\*Not enough space for 2 Dry chairs side by side

Other sizes and finishes are available, please contact our sales office.

Choice of other colours - Formica Colors, Forbo Linoleum and Fenix laminate: 10% surcharge

### Frame colour

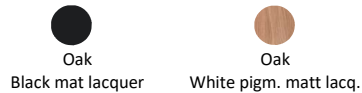

### PRODUCT HIGHLIGHTS

- Folding table
- Passed: EN15372
- Closed aluminium beam
- Press the release button and the legs fold, can be managed by just one person
- Stacking height: only 7cm per table - also with chair hanger
- High stability - extraordinary quality
- The table comes with 4 stacking buffers
- Top thickness: 20 mm
- Solid wood legs
- Free space between the gables: width minus 12 cm



## TUBE COUNTER - HIGH TABLES

Design: Randers+Radius

Tabletop	ABS edge				Plywood edge		
	Decor Laminate	HPL Laminate	Fenix Laminate	Linoleum*	HPL Laminate	Fenix Laminate	Linoleum*

### TC6140- 140x60xH90 cm

Frame colour (Grp. 1): Black - Corner: round / square

1-4 pcs.	919	993	1.088	1.119	1.131	1.278	1.215
<b>5+ pcs.</b>	<b>751</b>	<b>825</b>	<b>915</b>	<b>946</b>	<b>956</b>	<b>1.098</b>	<b>1.037</b>

Chair hanger: No

### TC6180- 180x60xH90 cm

Frame colour (Grp. 1): Black - Corner: round / square

1-4 pcs.	968	1.063	1.217	1.205	1.229	1.417	1.302
<b>5+ pcs.</b>	<b>798</b>	<b>890</b>	<b>1.041</b>	<b>1.029</b>	<b>1.051</b>	<b>1.295</b>	<b>1.122</b>

Chair hanger: No

\*Please treat linoleum surfaces with care when stacking in order to avoid scratches and pressure marks. We recommend vertical storage in our transport trolley - table top against table top.

Other sizes and finishes are available, please contact our sales office.

Choice of other colours - Formica Colors, Forbo Linoleum and Fenix laminate: 10% surcharge

### Surcharge

Frame surface in chrome (Grp. 2)	<b>53</b>
----------------------------------	-----------

### Frame colour

Grp. 1



Black

Grp. 2



Chrome

### PRODUCT HIGHLIGHTS

- Folding table
- Passed: EN15372
- Closed aluminium beam
- Press the release button and the legs fold, can be managed by just one person
- Stacking height: only 7cm per table - also with chair hanger
- High stability - extraordinary quality
- The table comes with 4 stacking buffers
- Top thickness: 20 mm
- Height: 90 cm



## TUBE STAY - TABLES

Design: Randers+Radius

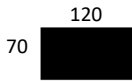

Tabletop	ABS edge				Plywood edge		
	Decor Laminate	HPL Laminate	Fenix Laminate	Linoleum*	HPL Laminate	Fenix Laminate	Linoleum*

### TS7120- 120x70xH73 cm

Frame colour (Grp. 1): Black - Corner: round / square

1-4 pcs.	666	739	856	866	871	1.019	980
<b>5+ pcs.</b>	<b>507</b>	<b>578</b>	<b>692</b>	<b>702</b>	<b>707</b>	<b>847</b>	<b>810</b>

Chair hanger: No

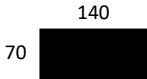

### TS7140- 140x70xH73 cm

Frame colour (Grp. 1): Black - Corner: round / square

1-4 pcs.	681	761	905	903	914	1.083	1.015
<b>5+ pcs.</b>	<b>522</b>	<b>600</b>	<b>739</b>	<b>737</b>	<b>746</b>	<b>910</b>	<b>846</b>

Chair hanger: No

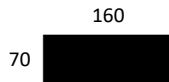

### TS7160- 160x70xH73 cm

Frame colour (Grp. 1): Black - Corner: round / square

1-4 pcs.	702	803	941	946	961	1.156	1.059
<b>5+ pcs.</b>	<b>542</b>	<b>641</b>	<b>773</b>	<b>778</b>	<b>792</b>	<b>980</b>	<b>888</b>

Chair hanger: No

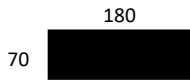

### TS7180- 180x70xH73 cm

Frame colour (Grp. 1): Black - Corner: round / square

1-4 pcs.	722	837	1.010	990	1.008	1.227	1.098
<b>5+ pcs.</b>	<b>563</b>	<b>673</b>	<b>841</b>	<b>820</b>	<b>837</b>	<b>1.049</b>	<b>925</b>

Chair hanger: No

\*Please treat linoleum surfaces with care when stacking in order to avoid scratches and pressure marks. We recommend vertical storage in our transport trolley - table top against table top.

Other sizes and finishes are available, please contact our sales office.

Choice of other colours - Formica Colors, Forbo Linoleum and Fenix laminate: 10% surcharge

### Surcharge

Frame surface in chrome (Grp. 2)	<b>53</b>
----------------------------------	-----------

### Frame colour

Grp. 1



Black

Grp. 2



Chrome

### PRODUCT HIGHLIGHTS

- Not foldable - fixed table
- Passed: EN15372
- Open aluminium beam
- High stability - extraordinary quality
- Top thickness: 20 mm
- Free space between the gables: width minus 12 cm



## TUBE STAY - TABLES

Design: Randers+Radius

Tabletop	ABS edge				Plywood edge		
	Decor Laminate	HPL Laminate	Fenix Laminate	Linoleum*	HPL Laminate	Fenix Laminate	Linoleum*

### TS8080- 80x80xH73 cm

Frame colour (Grp. 1): Black - Corner: round / square

1-4 pcs.	632	685	776	802	846	915	847
<b>5+ pcs.</b>	<b>475</b>	<b>525</b>	<b>614</b>	<b>639</b>	<b>681</b>	<b>747</b>	<b>683</b>

Chair hanger: Yes, 2 chairs (see overview on page 138)



### TS8120- 120x80xH73 cm

Frame colour (Grp. 1): Black - Corner: round / square

1-4 pcs.	686	775	902	907	915	1.083	1.044
<b>5+ pcs.</b>	<b>527</b>	<b>612</b>	<b>736</b>	<b>739</b>	<b>747</b>	<b>910</b>	<b>871</b>

Chair hanger: Yes, 4 chairs\*\* (see overview on page 138)

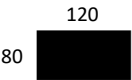

### TS8140- 140x80xH73 cm

Frame colour (Grp. 1): Black - Corner: round / square

1-4 pcs.	702	798	956	947	961	1.208	1.083
<b>5+ pcs.</b>	<b>542</b>	<b>636</b>	<b>788</b>	<b>780</b>	<b>792</b>	<b>1.032</b>	<b>910</b>

Chair hanger: Yes, 4 chairs (see overview on page 138)

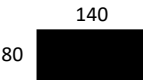

### TS8160- 160x80xH73 cm

Frame colour (Grp. 1): Black - Corner: round / square

1-4 pcs.	724	839	1.037	993	1.012	1.234	1.125
<b>5+ pcs.</b>	<b>564</b>	<b>675</b>	<b>866</b>	<b>824</b>	<b>842</b>	<b>1.056</b>	<b>951</b>

Chair hanger: Yes, 4 chairs (see overview on page 138)

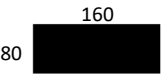

### TS8180- 180x80xH73 cm

Frame colour (Grp. 1): Black - Corner: round / square

1-4 pcs.	746	871	1.073	1.041	1.063	1.314	1.171
<b>5+ pcs.</b>	<b>585</b>	<b>707</b>	<b>900</b>	<b>869</b>	<b>892</b>	<b>1.132</b>	<b>995</b>

Chair hanger: Yes, 6 chairs (see overview on page 138)

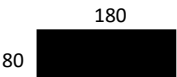

\*Please treat linoleum surfaces with care when stacking in order to avoid scratches and pressure marks. We recommend vertical storage in our transport trolley - table top against table top.

\*\*Not enough space for 2 Dry chairs side by side

Other sizes and finishes are available, please contact our sales office.

Choice of other colours - Formica Colors, Forbo Linoleum and Fenix laminate: 10% surcharge

### Surcharge

Frame surface in chrome (Grp. 2)

53

### Frame colour

Grp. 1



Black

Grp. 2



Chrome

### PRODUCT HIGHLIGHTS

- Not foldable - fixed table
- Passed: EN15372
- Open aluminium beam
- Available with chair hanger
- High stability - extraordinary quality
- Top thickness: 20 mm
- Free space between the gables: width minus 12 cm



## TUBE STAY - TABLES

Design: Randers+Radius

Tabletop	ABS edge				Plywood edge		
	Decor Laminate	HPL Laminate	Fenix Laminate	Linoleum*	HPL Laminate	Fenix Laminate	Linoleum*

### TS0110- Ø110xH73 cm

Frame colour (Grp. 1): Black - Corner: round / square

1-4 pcs.	707	825	1.025	998	900	1.110	1.088
<b>5+ pcs.</b>	<b>547</b>	<b>663</b>	<b>856</b>	<b>829</b>	<b>734</b>	<b>937</b>	<b>915</b>

Chair hanger: No

### TS0120- Ø120xH73 cm

Frame colour (Grp. 1): Black - Corner: round / square

1-4 pcs.	724	875	1.042	1.069	946	1.195	1.147
<b>5+ pcs.</b>	<b>563</b>	<b>708</b>	<b>871</b>	<b>883</b>	<b>778</b>	<b>1.019</b>	<b>973</b>

Chair hanger: No

\*Please treat linoleum surfaces with care when stacking in order to avoid scratches and pressure marks. We recommend vertical storage in our transport trolley - table top against table top.

Other sizes and finishes are available, please contact our sales office.

Choice of other colours - Formica Colors, Forbo Linoleum and Fenix laminate: 10% surcharge

### Surcharge

Frame surface in chrome (Grp. 2)

**53**

### Frame colour

Grp. 1



Black

Grp. 2



Chrome

### PRODUCT HIGHLIGHTS

- Not foldable - fixed table
- Passed: EN15372
- Open aluminium beam
- High stability - extraordinary quality
- Top thickness: 20 mm
- Free space between the gables: width minus 12 cm

## TUBE - MODESTY PANEL/END PANEL

Design: Randers+Radius

Tabletop	Black Fenix laminate
Edge	ABS Edge
<b>TFRONT30080</b> Tube modesty panel - 80 x 30 cm	<b>314</b>
<b>TFRONT30120</b> Tube modesty panel - 120 x 30 cm	<b>380</b>
<b>TFRONT30140</b> Tube modesty panel - 1400 x 30 cm	<b>395</b>
<b>TFRONT30160</b> Tube modesty panel - 1600 x 30 cm	<b>412</b>
<b>TFRONT30180</b> Tube modesty panel - 180 x 30 cm	<b>446</b>
<b>TGAVL8064</b> End panel - 64 x 80 cm	<b>431</b>



## TUBE - TRANSPORT TROLLEY

Design: Randers+Radius

<b>TU7401</b> Transport and storage trolley for 10 tables - 111x45xH113 cm	<b>1.078</b>
---	--------------



## TUBE - COUPLING BRACKET

<b>9-9BES00013</b> Coupling bracket - Click Catch - Set	<b>24</b>
--	-----------





# T1 - SERIES

Design: byKATO

## TABLE TOP - LAMINATE (HPL)



White (Alpino)  
K1040



Kashmir  
F0187



Cafe  
F0903



Terril  
F2297



Diamond Black  
F2253



Ocean Grey  
F7853



Pumice  
F7858



Silver  
F2791



Iron  
F7902



Pale Olive  
F3007



Artic Blue  
F5493



Lead  
F7924



Mouse  
F7928

## TABLE TOP - FENIX LAMINATE



Black (Nero Ingo)  
0720



Bianco Male  
0029



Beige Luxor  
0719



Beige Arizona  
0748



Castoro Ottawa  
0717



Cacao Orinoco  
0749



Grigio Efeso  
0725



Grigio Antrim  
0752



Grigio Londra  
0718



Grigio Bromo  
0724



Rosso Jaipur  
0751



Verde Comodoro  
0750



Blu Fes  
0754

## TABLE TOP - LINOLEUM



Black (Nero)  
4023



Ash  
4132



Burgundy  
4154



Mauve  
4172



Mushrom  
4176



Olive  
4184



Pebble  
4175



Pewter  
4155



Pistachio  
4183



Smokey Blue  
4179



Vapour  
4177



Charcoal  
4166



Conifer  
4174

## LEGS / SUPPORTING FRAME



Oak  
Whitepig. matt lacquer



Oak  
Clear matt lacquer



Oak  
Black matt lacquer



Oak  
Smoked matt lacquer



Walnut  
Natural oil



# T1 - TABLES

Design: byKATO

Table top	White Laminate (HPL)	Coloured Laminate (HPL)	Black Fenix Laminate*	Black Linoleum**
Edge	Edge blackpainted***	Edge blackpainted***	Edge blackpainted***	Edge blackpainted***
<b>2-3001- 160x88xH72,5 cm</b>				
Legs: Oak lacquerd ****	<b>1.720</b>	<b>1.854</b>	<b>1.986</b>	<b>1.986</b>
Legs: Walnut/Oil	<b>1.986</b>	<b>2.120</b>	<b>2.253</b>	<b>2.253</b>
<b>2-3003- 180x95xH72,5 cm</b>				
Legs: Oak lacquerd ****	<b>1.854</b>	<b>1.986</b>	<b>2.120</b>	<b>2.120</b>
Legs: Walnut/Oil	<b>2.120</b>	<b>2.253</b>	<b>2.385</b>	<b>2.385</b>
<b>2-3005- 220x95xH72,5 cm</b>				
Legs: Oak lacquerd ****	<b>1.986</b>	<b>2.120</b>	<b>2.253</b>	<b>2.253</b>
Legs: Walnut/Oil	<b>2.253</b>	<b>2.385</b>	<b>2.519</b>	<b>2.519</b>
<b>2-3053- 240x110xH72,5 cm</b>				
Legs: Oak lacquerd ****	<b>2.120</b>	<b>2.253</b>	<b>2.385</b>	<b>2.385</b>
Legs: Walnut/Oil	<b>2.385</b>	<b>2.519</b>	<b>2.651</b>	<b>2.651</b>
<b>2-3058- 295x110xH72,5 cm</b>				
Legs: Oak lacquerd ****	<b>2.519</b>	<b>2.651</b>	<b>2.785</b>	<b>2.785</b>
Legs: Walnut/Oil	<b>2.785</b>	<b>2.917</b>	<b>3.049</b>	<b>3.049</b>

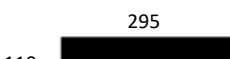
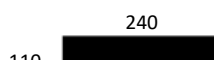
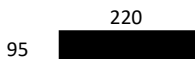
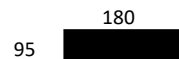
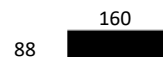

## Surcharge

\* Additional fee for other Fenix laminate colours than black: 15%

\*\* Additional fee for other linoleum colours than black: 15%

\*\*\* Additional fee for edge painted in colour as laminate: 10%

\*\*\*\* Choose between: Whitepigmented matt lacquer / Clear matt lacquer / Black matt lacquer / Smoked matt lacquer

## PRODUCT HIGHLIGHTS

- Possibility of cable cover - please see at page 82
- Model 2-3001: W 46 kg / CBM 0,27
- Model 2-3003: W 50 kg / CBM 0,30
- Model 2-3005: W 60 kg / CBM 0,34
- Model 2-3053: W 72 kg / CBM 0,45
- Model 2-3058: W 88 kg / CBM 0,45

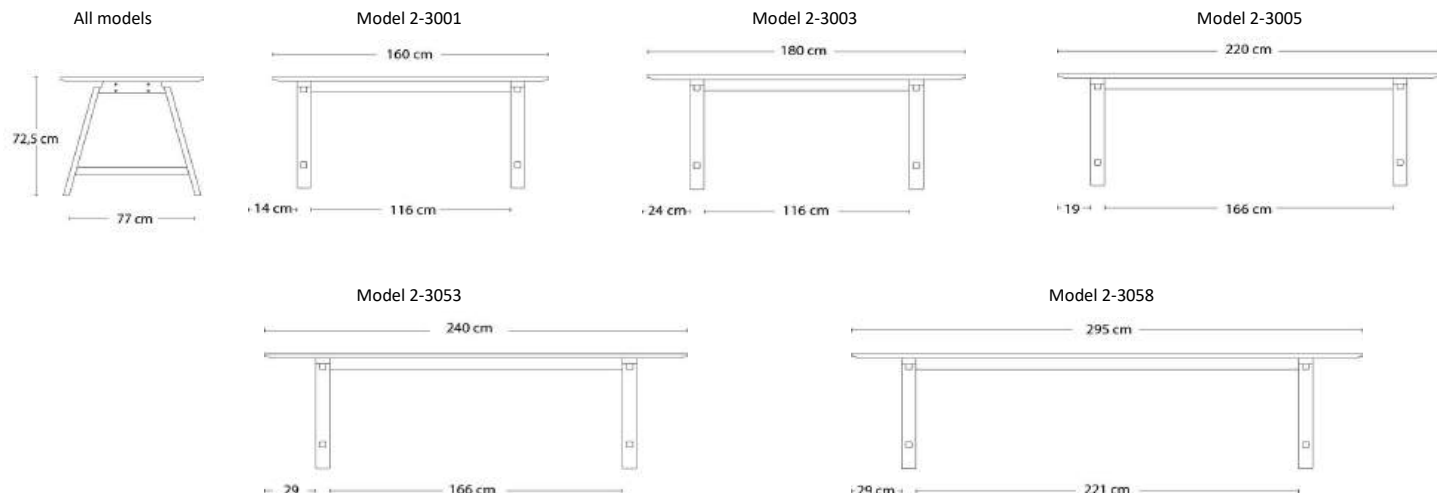

# T1 - TABLES - WIDE MODEL

Design: byKATO

Table top			White Laminate (HPL)	Coloured Laminate (HPL)	Black Fenix Laminate*	Black Linoleum**
Kant			Edge blackpainted***	Edge blackpainted***	Edge blackpainted***	Edge blackpainted***
<b>Width 120 cm Legs in oak - choose between: Whitepigm. matt lacquer / Clear matt lacquer / Black lacquer / Smoked matt lacquer</b>						
2-3105-	220x120xH72,5 cm		2.141	2.295	2.447	2.447
2-3107-	240x120xH72,5 cm		2.295	2.447	2.602	2.602
2-3109-	295x120xH72,5 cm		2.631	2.776	2.924	2.924
2-3113-	360x120xH72,5 cm	2 table tops / 3 legs	3.744	3.939	4.346	4.346
2-3117-	420x120xH72,5 cm	2 table tops / 3 legs	4.256	4.454	5.015	5.015
2-3122-	600x120xH72,5 cm	3 table tops / 4 legs	6.132	6.342	7.192	7.192
2-3125-	720x120xH72,5 cm	4 table tops / 5 legs	8.522	8.744	9.864	9.864
<b>Width 140 cm Legs in oak - choose between: Whitepigm. matt lacquer / Clear matt lacquer / Black lacquer / Smoked matt lacquer</b>						
2-3205-	210x140xH72,5 cm	2 table tops / 2 legs	2.551	2.737	3.005	3.005
2-3207-	240x140xH72,5 cm	2 table tops / 2 legs	2.636	2.824	3.090	3.090
2-3209-	315x140xH72,5 cm	3 table tops / 2 legs	3.403	3.595	4.010	4.010
2-3213-	360x140xH72,5 cm	3 table tops / 3 legs	4.086	4.283	4.680	4.680
2-3217-	420x140xH72,5 cm	4 table tops / 3 legs	4.939	5.141	5.517	5.517
2-3222-	600x140xH72,5 cm	5 table tops / 4 legs	6.475	6.685	7.359	7.359
2-3225-	720x140xH72,5 cm	6 table tops / 5 legs	8.863	9.088	10.290	10.290
<b>Width 160 cm Legs in oak - choose between: Whitepigm. matt lacquer / Clear matt lacquer / Black lacquer / Smoked matt lacquer</b>						
2-3305-	210x160xH72,5 cm	2 table tops / 2 legs	2.892	3.166	3.341	3.341
2-3307-	240x160xH72,5 cm	2 table tops / 2 legs	2.976	3.339	3.592	3.592
2-3309-	315x160xH72,5 cm	3 table tops / 2 legs	3.915	4.110	4.346	4.346
2-3313-	360x160xH72,5 cm	3 table tops / 3 legs	4.598	4.797	5.015	5.015
2-3317-	420x160xH72,5 cm	4 table tops / 3 legs	5.451	5.654	5.853	5.853
2-3322-	600x160xH72,5 cm	5 table tops / 4 legs	7.156	7.371	7.693	7.693
2-3325-	720x160xH72,5 cm	6 table tops / 5 legs	9.886	10.290	10.980	10.980

## Surcharge

\* Additional fee for other Fenix laminate colours than black: 15%

\*\* Additional fee for other linoleum colours than black: 15%

\*\*\* Additional fee for edge painted in colour as laminate: 10%

## PRODUCT HIGHLIGHTS

- Possibility of cable cover - please see at page 82



# HT1 - HIGH TABLE

Design: byKATO

Tabletop	White Laminate (HPL)	Coloured Laminate (HPL)	Black Fenix Laminate*	Black Linoleum**
Edge	Edge blackpainted***	Edge blackpainted***	Edge blackpainted***	Edge blackpainted***

Height 93 cm Legs in oak - choose between: Whitepigm. matt lacquer / Clear matt lacquer / Black lacquer / Smoked matt lacquer

75 **150**

## 2-30202- 150x75xH93 cm

Legs: Oak/Lacquer **1.720** **1.854** **1.986** **1.986**

75 **216**

## 2-30212- 216x75xH93 cm

Legs: Oak/Lacquer **1.986** **2.120** **2.253** **2.253**

75 **273**

## 2-30252- 273x75x93 cm

Legs: Oak/Lacquer **2.253** **2.385** **2.519** **2.519**

Height 108 cm Legs in oak - choose between: Whitepigm. matt lacquer / Clear matt lacquer / Black lacquer / Smoked matt lacquer

75 **150**

## 2-31202- 150x75x108 cm

Legs: Oak/Lacquer **1.720** **1.854** **1.986** **1.986**

75 **216**

## 2-31212- 216x75x108 cm

Legs: Oak/Lacquer **1.986** **2.120** **2.253** **2.253**

75 **273**

## 2-31251- 273x75x108 cm

Legs: Oak/Lacquer **2.253** **2.385** **2.519** **2.519**

### Surcharge

- \* Additional fee for other Fenix laminate colours than black: 15%
- \*\* Additional fee for other linoleum colours than black: 15%
- \*\*\* Additional fee for edge painted in colour as laminate: 10%

### PRODUCT HIGHLIGHTS

- The footrest is covered in a stainless steel cap.
- Model 2-3020: W 40 kg / CBM 0,28
- Model 2-3025: W 60 kg / CBM 0,40
- Model 2-3027: W 75 kg / CBM 0,50

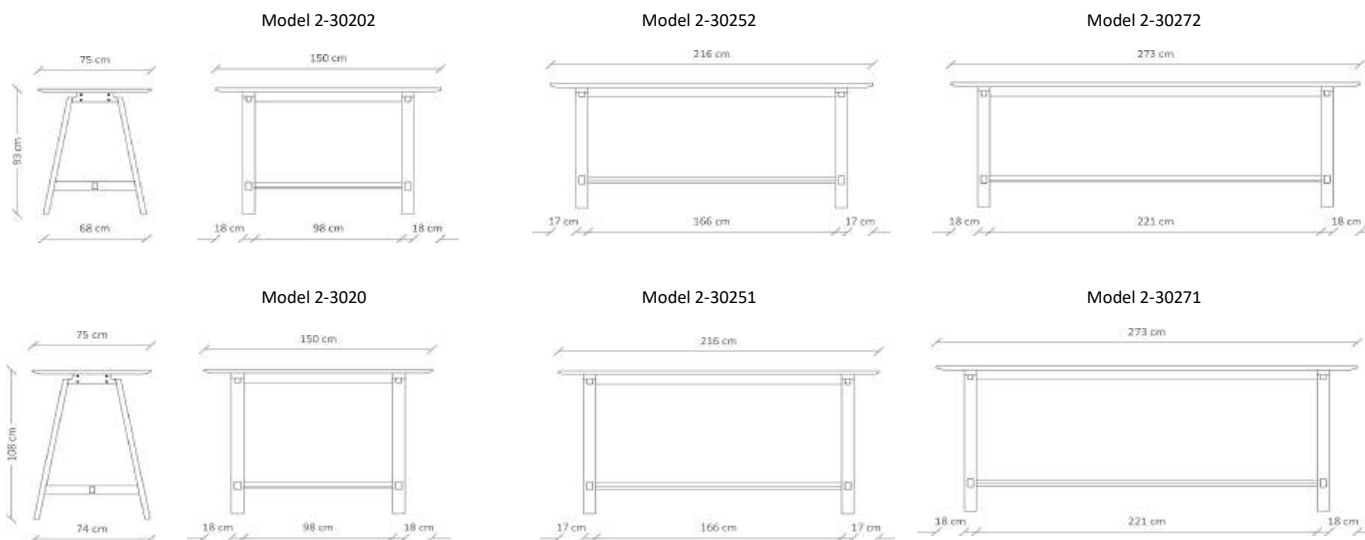

# HT1 - HIGH TABLE - WIDE MODEL

Design: byKATO

Tabletop	White Laminate (HPL)	Coloured Laminate (HPL)	Black Fenix Laminate*	Black Linoleum**
Kant	Edge blackpainted***	Edge blackpainted***	Edge blackpainted***	Edge blackpainted***
<b>Height 93 cm Legs in oak - choose between: Whitepig. matt lacquer / Clear matt lacquer / Black lacquer / Smoked matt lacquer</b>				
2-30312- 216x100xH93 cm	2.225	2.364	2.505	2.505
2-30332- 240x100xH93 cm	2.295	2.410	2.758	2.758
2-30352- 273x100xH93 cm	2.644	2.783	2.924	2.924
2-30372- 360x100xH93 cm	2 table tops / 3 legs	3.676	3.859	4.059
2-30392- 480x100xH93 cm	2 table tops / 3 legs	4.136	4.344	4.710
2-30412- 216x120xH93 cm	2.644	2.783	2.924	2.924
2-30432- 240x120xH93 cm	2.908	3.054	3.408	3.408
2-30452- 273x120xH93 cm	3.273	3.412	3.551	3.551
2-30472- 360x120xH93 cm	2 table tops / 3 legs	4.290	4.505	5.036
2-30492- 480x120xH93 cm	2 table tops / 3 legs	5.210	5.469	6.012
<b>Height 108 cm Legs in oak - choose between: Whitepig. matt lacquer / Clear matt lacquer / Black lacquer / Smoked matt lacquer</b>				
2-31312- 216x100xH108 cm	2.225	2.364	2.505	2.505
2-31332- 240x100xH108 cm	2.295	2.410	2.758	2.758
2-31352- 273x100xH108 cm	2.644	2.783	2.924	2.924
2-31372- 360x100xH108 cm	2 table tops / 3 legs	3.676	3.859	4.059
2-31392- 480x100xH108 cm	2 table tops / 3 legs	4.136	4.344	4.710
2-31412- 216x120xH108 cm	2.644	2.783	2.924	2.924
2-31432- 240x120xH108 cm	2.908	3.054	3.408	3.408
2-31452- 273x120xH108 cm	3.273	3.412	3.551	3.551
2-31472- 360x120xH108 cm	2 table tops / 3 legs	4.290	4.505	5.036
2-31492- 480x120xH108 cm	2 table tops / 3 legs	5.210	5.469	6.012

## Surcharge

\* Additional fee for other Fenix laminate colours than black: 15%

\*\* Additional fee for other linoleum colours than black: 15%

\*\*\* Additional fee for edge painted in colour as laminate: 10%

## PRODUCT HIGHLIGHTS

- Possibility of cable cover - please see at page 82

# T1 - EXTENDABLE TABLE

Design: byKATO

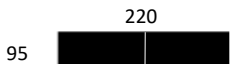
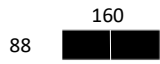

Tabletop	White Laminate (HPL)	Coloured Laminate (HPL)	Black Fenix Laminate*	Black Linoleum**
Edge	Edge blackpainted	Edge blackpainted	Edge blackpainted	Edge blackpainted

**2-3006A 88x160xH72,5 cm**  
Extension for 3 leaves (1 pc. black supporting leg included)

Legs: Oak lacquerd ***	<b>1.807</b>	<b>2.047</b>	<b>2.168</b>	<b>2.047</b>
Legs: Walnut/Oil	<b>2.047</b>	<b>2.290</b>	<b>2.410</b>	<b>2.290</b>

**2-3008A 95x180xH72,5 cm**  
Extension for 3 leaves (1 pc. black supporting leg included)

Legs: Oak lacquerd ***	<b>1.927</b>	<b>2.168</b>	<b>2.290</b>	<b>2.168</b>
Legs: Walnut/Oil	<b>2.168</b>	<b>2.410</b>	<b>2.531</b>	<b>2.410</b>

**2-3010A 95x220xH72,5 cm**  
Extension for 4 leaves (1 pc. black supporting leg included)

Legs: Oak lacquerd ***	<b>2.047</b>	<b>2.290</b>	<b>2.410</b>	<b>2.290</b>
Legs: Walnut/Oil	<b>2.290</b>	<b>2.531</b>	<b>2.651</b>	<b>2.531</b>

	Black Painted	White Laminate (HPL)	Coloured Laminate (HPL)	Black Fenix Laminate	Black Linoleum
<b>Leaf</b>					
2-3017 50x88 cm	<b>241</b>	<b>297</b>	<b>417</b>	<b>441</b>	<b>417</b>
2-3015 50x95 cm	<b>241</b>	<b>297</b>	<b>417</b>	<b>441</b>	<b>417</b>

\* Note: The T1 extendable table with linoleum is only available with leaves with linoleum

\*\* The edge of the tabletop og leaves is always blacklacquered

\*\*\* Choose between: Whitepigmented matt lacquer / Clear matt lacquer / Black matt lacquer

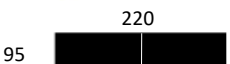

<b>Table top and legs in solid oak</b>	Oak Soap	Oak Oil *
--	----------	-----------

<b>2-3010M 95x220xH72,5 cm</b> Extension for 4 leaves (1 pc. black supporting leg included)	<b>3.136</b>	<b>3.256</b>
--	--------------	--------------

<b>Leaf</b>		Antracite Grey Painted	Oak Soap	Oak Oil *
2-3015M 50x95 cm	<b>264</b>			
2-3015MA 50x95 cm			<b>598</b>	<b>658</b>

\* Oak/Oil - Choose between: White oil - Natural oil

## PRODUCT HIGHLIGHTS

- Model 2-3006: W 58 kg / CBM 0,30
- Model 2-3008: W 62 kg / CBM 0,30
- Model 2-3010: W 73 kg / CBM 0,34
- Model 2-3010M: W 73 kg / CBM 0,40

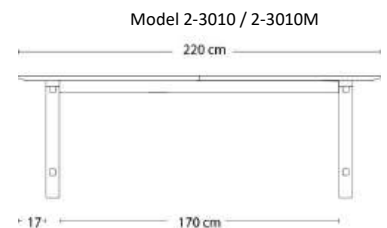
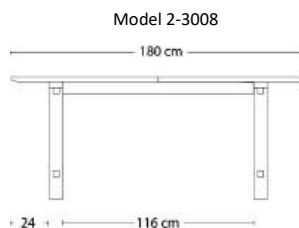
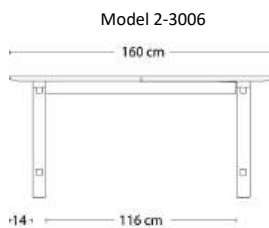



## B2 - BENCH

Design: Andersen Design Team

Oak  
Whitepig. matt lacquer

40 

200

**0-7320M0213**    **200x40xH45 cm**

Legs: Oak/Whitepigmented matt lacquer

**1.522**

### PRODUCT HIGHLIGHTS

- W 25 kg / CBM 0,1

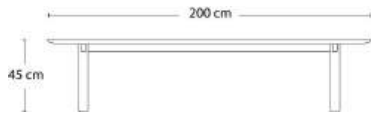

# T3 - EXTENDABLE TABLE

Design: byKATO

## TABLE TOP - LAMINATE (HPL)



White (Alpino)  
K1040



Kashmir  
F0187



Cafe  
F0903



Terril  
F2297



Diamond Black  
F2253



Ocean Grey  
F7853



Pumice  
F7858



Silver  
F2791



Iron  
F7902



Pale Olive  
F3007



Artic Blue  
F5493



Lead  
F7924



Mouse  
F7928

## TABLE TOP - FENIX LAMINATE



Black (Nero Ingo)  
0720

## LEGS / SUPPORTING FRAME



Oak  
White oil



Oak  
Natural oil



Oak  
Soap



## T3 - EXTENDABLE TABLE

Design: byKATO

Tabletop	White Laminate (HPL)	Coloured Laminate (HPL)	Black Fenix Laminate
Edge	Underglued wooden edge in oak	Underglued wooden edge in oak	Underglued wooden edge in oak

**2-4005 2-4005 95x200xH74 cm**

Incl. synchronous extension

Integrated leaf 100x95 cm

Oak/Soap	<b>3.497</b>	<b>3.619</b>	<b>3.739</b>
Oak/Oil (Whiteoil/Natural oil)	<b>3.497</b>	<b>3.619</b>	<b>3.739</b>



### PRODUCT HIGHLIGHTS

- W 75 kg / CBM 0,25

- Functional synchronised extension system that makes handling the leaf inserts especially easy

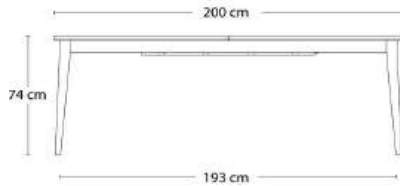

## T7 - EXTENDABLE TABLE

Design: Ditlev Karsten

### TABLE TOP - LAMINATE (HPL)



White (full coloured)

### TABLE TOP - FENIX LAMINATE



Black (Nero Ingo)  
0720

### LEGS / SUPPORTING FRAME



Oak  
White oil



Oak  
Natural oil



Oak  
Soap



Oak  
Black matt lacquer





## T7 - EXTENDABLE TABLE

Design: Ditlev Karsten

Tabletop	Solid white Laminate	Black Fenix Laminate
Edge	Edge whitepainted	Black lacquered edge

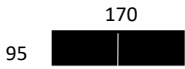

### 2-5702 95x170xH72,5 cm

Extension for 3 leaves

Oak/Soap	<b>2.893</b>	<b>3.136</b>
Oak/Oil (Whiteoil/Natural oil)	<b>2.893</b>	<b>3.136</b>
Oak/Black matt lacquered)	<b>2.893</b>	<b>3.136</b>



### 2-5700 95x220xH72,5 cm

Extension for 4 leaves

Oak/Soap	<b>3.014</b>	<b>3.256</b>
Oak/Oil (Whiteoil/Natural oil)	<b>3.014</b>	<b>3.256</b>
Oak/Black matt lacquered)	<b>3.014</b>	<b>3.256</b>

	Solid white Laminate	Black Fenix Laminate	White Lacquered
--	----------------------	----------------------	-----------------

Leaf				
2-5710	50x95 cm	<b>417</b>	<b>453</b>	<b>271</b>



### Table top and legs in solid oak

Oak Soap	Oak Oil *
----------	-----------



### 2-5800 95x220xH72,5 cm

Extension for 4 leaves

Oak	<b>3.376</b>	<b>3.497</b>
-----	--------------	--------------

	Anthracite grey lacquered	Oak Soap	Oak Oil *
--	---------------------------	----------	-----------

Leaf				
2-5809	50x95 cm	<b>271</b>		
2-5812MA	50x95 cm		<b>598</b>	<b>658</b>

\* Oak/Oil - Choose between: White oil - Natural oil

### PRODUCT HIGHLIGHTS

- Model 2-5702: W 68 kg / CBM 0,27
- Model 2-5700 / 2-5800: W 78 kg / CBM 0,35

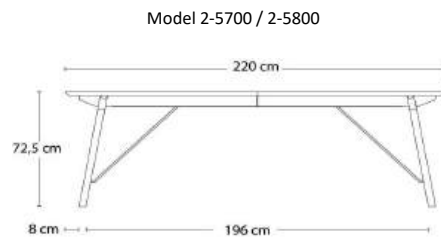
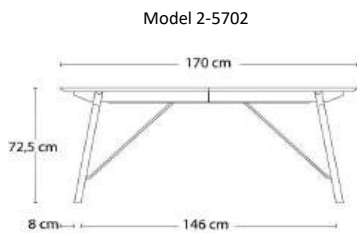

# T8 - TABLES

Design: Weitz & Wendland

## TABLE TOP - LAMINATE (HPL)



White (Alpino)  
K1040



Kashmir  
F0187



Cafe  
F0903



Terril  
F2297



Diamond Black  
F2253



Ocean Grey  
F7853



Pumice  
F7858



Silver  
F2791



Iron  
F7902



Pale Olive  
F3007



Artic Blue  
F5493



Lead  
F7924



Mouse  
F7928

## TABLE TOP - FENIX LAMINATE



Black (Nero Ingo)  
0720



Bianco Male  
0029



Beige Luxor  
0719



Beige Arizona  
0748



Castoro Ottawa  
0717



Cacao Orinoco  
0749



Grigio Efeso  
0725



Grigio Antrim  
0752



Grigio Londra  
0718



Grigio Bromo  
0724



Rosso Jaipur  
0751



Verde Comodoro  
0750



Blu Fes  
0754

## TABLE TOP - LINOLEUM



Black (Nero)  
4023



Ash  
4132



Burgundy  
4154



Maive  
4172



Mushrom  
4176



Olive  
4184



Pebble  
4175



Pewter  
4155



Pistachio  
4183



Smokey Blue  
4179



Vapour  
4177



Charcoal  
4166



Conifer  
4174

## LEGS / SUPPORTING FRAME



Oak  
Whitepig. matt lacquer



Oak  
Clear matt lacquer



Oak  
Black lacquer



Oak  
Smoked matt lacquer



## T8 - TABLES

Design: Weitz & Wendland

Table top	White Laminate (HPL) *	White Laminate (HPL)	Black Fenix Laminate **	Black Fenix Laminate
Edge	Black lacquered Bevelled ***	Edge banding oak veneer	Black lacquered Bevelled ***	Edge banding oak veneer

**Legs/Frame in Oak - Choose between: Whitepig. matt lacquer / Clear matt lacquer / Black matt Lack / Smoked matt Lack**

### 0-8401- 120x104xH73,5 cm

Legs: Oak lacquer

1.854

1.986

2.120

2.385

### 0-8403- 150x127xH73,5 cm

Legs: Oak lacquer

2.120

2.253

2.385

2.651

### 0-8405- 173x150xH73,5 cm

Legs: Oak lacquer

2.385

2.519

2.651

2.917

### Surcharge

\* Additional fee for other laminate HPL colours than white: 15%

\*\* Black linoleum same price as black Fenix

Additional fee for other Fenix laminate and linoleum colours than black: 15%

\*\*\* Additional fee for edge painted in colour as laminate: 10%

### PRODUCT HIGHLIGHTS

- Model 0-8401: W 24 kg / CBM 0,20

- Model 0-8403: W 34 kg / CBM 0,30

- Model 0-8405: W 45 kg / CBM 0,40

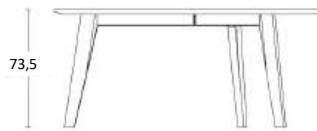
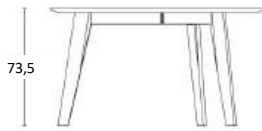
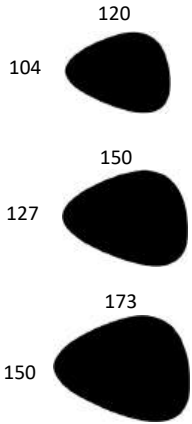

## T9 - EXTENDABLE TABLE

Design: Ditlev Karsten

### TABLE TOP - LAMINATE (HPL)



White (Alpino)  
K1040

### TABLE TOP - FENIX LAMINATE



Black (Nero Ingo)  
0720

### LEGS / SUPPORTING FRAME



Oak  
White oil



Oak  
Natural oil



Oak  
Soap





## T9 - EXTENDABLE TABLE

Design: byKATO

Tabletop	White Laminate (HPL)	Black Fenix Laminate
Edge	Underglued wooden edge in oak	Underglued wooden edge in oak



### 2-6402 95x180xH74,5 cm

Extension for 3 leaves / Storage for 2 leaves  
(1 pc. black supporting leg included)

Legs: Oak/Soap

2.410

2.773

Legs: Oak/Oil (White oil/Natural oil)

2.410

2.773



### 2-6400 95x220xH74,5 cm

Extension for 4 leaves / Storage for 4 leaves  
(1 pc. black supporting leg included)

Legs: Oak/Soap

2.410

2.773

Legs: Oak/Oil (White oil/Natural oil)

2.410

2.773

	Black Lacquer	White Laminate (HPL)	Black Fenix Laminate
--	---------------	----------------------	----------------------

### Leaf \*

2-6405	95x45 cm	297	476	537
--------	----------	-----	-----	-----

\* The leaf is 6mm thinner than the tabletop, so it can be stored in the magazine.

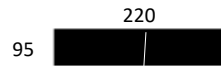

### Table top and legs in solid oak

Oak Soap

Oak Oil \*\*

### 2-6400M 95x220xH74,5 cm

Extension for 4 leaves / Storage for 4 leaves  
(1 pc. black supporting leg included)

Oak

2.893

3.014

	Anthracite grey Lacquered	Oak Soap	Oak Oil **
--	---------------------------	----------	------------

### Leaf \*

2-6407	95x45 cm	297		
2-6405MA	95x45 cm **		598	658

\* The leaf is 6mm thinner than the tabletop, so it can be stored in the magazine.

\*\* Oak/Oil - Choose between: White oil - Natural oil

### PRODUCT HIGHLIGHTS

- Model 2-6402A/2-6402M: W 75 kg / CBM 0,22

- Model 2-6400A/2-6400M: W 86 kg / CBM 0,26

All models



Model 2-6402A / 2-6402M

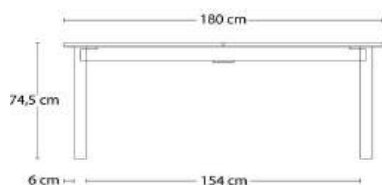

Model 2-6400A / 2-6400M

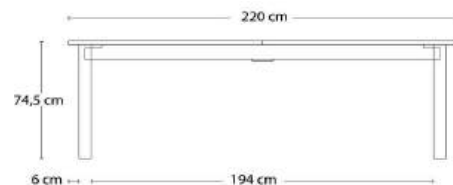



## T10 - EXTENDABLE TABLE

Design: byKATO

Table top in veneer and legs in solid oak

Oak Whitepigmented  
matt lacquer

95



200

**7-211020**      **95x200xH74,5 cm**  
Incl. synchronous extension  
Incl. two integrated leaves, each 50 cm

**1.812**

### Table legs



Solid Oak  
White pigment.

### Table top



Oak Veneer  
White pigment.

### PRODUCT HIGHLIGHTS

- Model 7-211020: W 75 kg / CBM 1,4
- Functional synchronised extension system that makes handling the leaf inserts especially easy

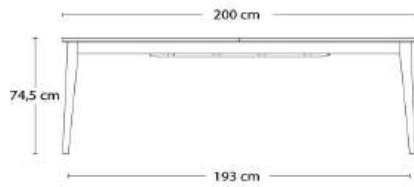



# T11 - EXTENDABLE TABLE

Design: byKATO

**Tabletop** White laminate - Matt (Crystal white)

Edge Wooden edge in oak

**7-3110 95x220xH74 cm**

Extension for 4 leaves

Legs: Oak/Whitepigmented matt lacquer

**2.410**

Note: Extension leaves are only sold in boxes of 2

White laminate w/wooden edge

## Leaf

**7-3120 50x95 cm 2 pcs.**

**658**

**Table legs**

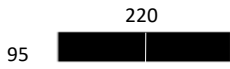
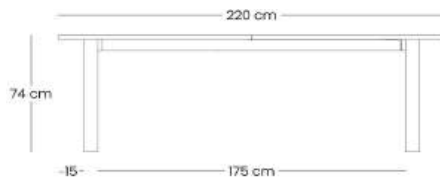
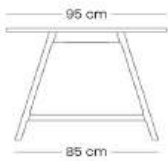

**Table top**



## PRODUCT HIGHLIGHTS

- W 68 kg / CBM 0,26



## SOLUTIONS FOR CABLES & POWER

Covers	Veneer*	Linoleum	Laminate	Solid wood
<b>0-2105-</b> Flip Cover	L34 x B11 cm	<b>486</b>	<b>486</b>	<b>486</b>
<b>0-2115-</b> Drop-in Cover	L29 x B11 cm	<b>256</b>	<b>256</b>	<b>332</b>
<b>0-2150-</b> Single Cover	L29 x B11 cm	<b>225</b>	<b>225</b>	<b>302</b>
<b>0-2160-</b> Double Cover	L29 x B11 cm	<b>302</b>	<b>302</b>	<b>376</b>

\* Colour and texture differences between cable covers and tabletops may occur.

Cable Tray	Black
<b>9-7418</b> Cable tray for round Space tables - L25xW25xH8 cm	<b>81</b>
<b>9-7420</b> Cable tray for high tables - L53xW13,5xH12 cm	<b>81</b>
<b>9-7421</b> Cable tray for meeting tables - L53xW20xH13 cm	<b>81</b>

### Power solutions

<b>9-7441-SC</b>	6 pcs. 230V * - for DK/DE/NO/SE	<b>242</b>
<b>9-7441-CH</b>	6 pcs. 230V * - for CH	<b>351</b>
<b>9-7441-UK</b>	4 pcs. 230V * - for UK	<b>254</b>
<b>9-7442-SC</b>	4 pcs. 230V + 1 pcs. HDMI * - for DK/DE/NO/SE	<b>363</b>
<b>9-7442-CH</b>	4 pcs. 230V + 1 pcs. HDMI * - for CH	<b>422</b>
<b>9-7442-UK</b>	3 pcs. 230V + 1 pcs. HDMI * - for UK	<b>363</b>
<b>9-7443-SC</b>	3 pcs. 230V + 1 pcs. HDMI + 1 pcs. USB A+C * - for DK/DE/NO/SE	<b>436</b>
<b>9-7443-CH</b>	3 pcs. 230V + 1 pcs. HDMI + 1 pcs. USB A+C * - for CH	<b>483</b>
<b>9-7443-UK</b>	2 pcs. 230V + 1 pcs. HDMI + 1 pcs. USB A+C * - for UK	<b>436</b>

\* The solution will be delivered with a 5 m power cable

Model 0-2105- Flip Cover

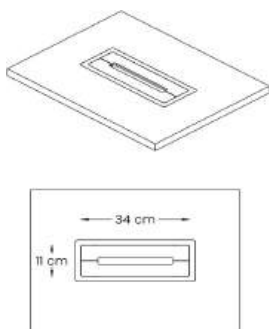

Model 0-2115- Drop-in Cover

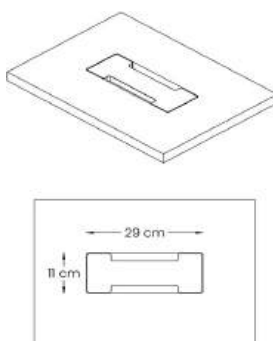

Model 0-2150- Single Cover

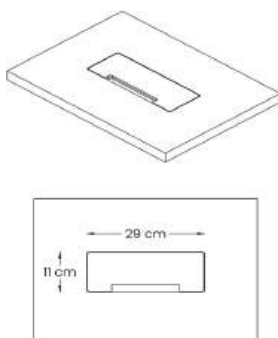

Model 0-2160- Double Cover

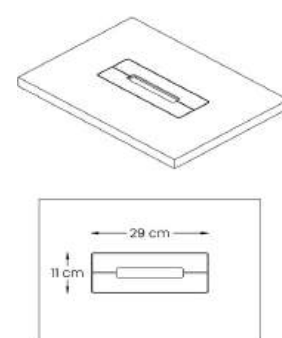

# SOLUTIONS FOR CABLES & POWER

Model 9-7418

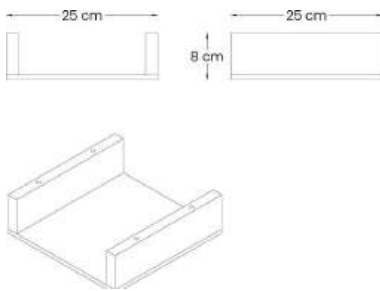

Model 9-7420

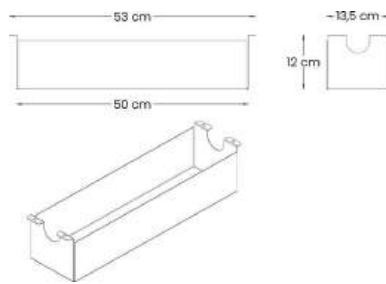

Model 9-7421

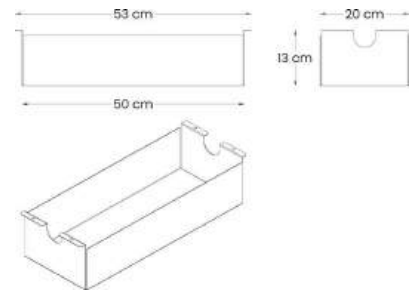

Model 9-7441-SC



Model 9-7441-CH



Model 9-7441-UK

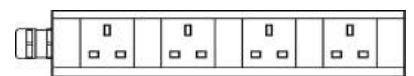

Model 9-7442-SC



Model 9-7442-CH

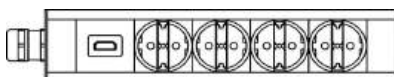

Model 9-7442-UK

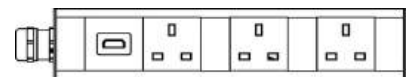

Model 9-7443-SC



Model 9-7443-CH



Model 9-7443-UK

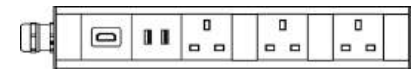



# D1 - DESK

Design: byKATO

Tabletop

Linoleum  
Charcoal 4166

Edge

Edge  
black lacquered

125

**2-5500 125x70xH74 cm**

70

Legs: Oak/Whitepigmented matt lacquer

**1.207**

**Table legs**



Solid Oak

**Table top**



Linoleum 4166

## PRODUCT HIGHLIGHTS

- W 27 kg / CBM 0,15

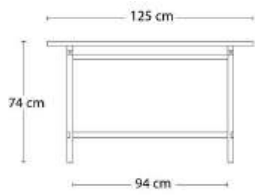

# COFFEE TABLES



# C1 - COFFEE TABLES

Design: byKATO

## TABLE TOP - LAMINATE (HPL)



White (Alpino)  
K1040



Kashmir  
F0187



Cafe  
F0903



Terril  
F2297



Diamond Black  
F2253



Ocean Grey  
F7853



Pumice  
F7858



Silver  
F2791



Iron  
F7902



Pale Olive  
F3007



Artic Blue  
F5493



Lead  
F7924



Mouse  
F7928

## LEGS / SUPPORTING FRAME (AND TABLE TOP)



Oak  
Soap



Oak  
White oil



Oak  
Natural oil



Oak  
Black lacquer

Shelf for model 2-3030

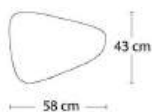

Model 2-3030

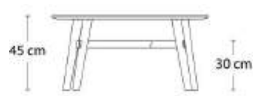

Shelf for model 2-3035

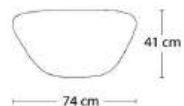

Model 2-3035

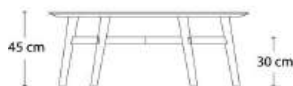

Shelf for model 2-3040

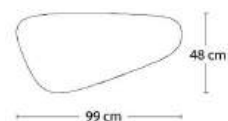

Model 2-3040



Shelf for model 2-3042

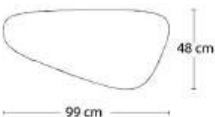

Model 2-3042



Shelf for model 2-3045

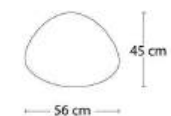

Model 2-3045

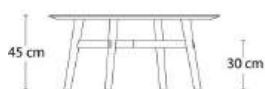



## C1 - COFFEE TABLES

Design: byKATO

Tabletop	White Laminate (HPL)	Coloured Laminate (HPL)
Edge	Edge black lacquered	Edge black lacquered

Legs in oak - Choose between: Soap / Oil / Black matt lacquer



<b>2-3030L</b>	<b>93x72xH45 cm</b>		
Legs: Oak		<b>900</b>	<b>961</b>



<b>2-3035L</b>	<b>120x70xH45 cm</b>		
Legs: Oak		<b>961</b>	<b>1.020</b>



<b>2-3040L</b>	<b>140x83xH45 cm</b>		
Legs: Oak		<b>1.081</b>	<b>1.202</b>



<b>2-3042L</b>	<b>140x83xH45 cm</b>	<b>Reversed</b>	
Legs: Oak			
		<b>1.081</b>	<b>1.202</b>

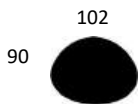

<b>2-3045L</b>	<b>102x90xH45 cm</b>		
Legs: Oak		<b>961</b>	<b>1.020</b>



Table top and legs in solid oak

Oak  
Soap / Oil / Black matt lacquer



<b>2-3030</b>	<b>93x72xH45 cm</b>		
Oak			<b>1.142</b>



<b>2-3035</b>	<b>120x70xH45 cm</b>		
Oak			<b>1.263</b>



<b>2-3040</b>	<b>140x83xH45 cm</b>		
Oak			<b>1.322</b>



<b>2-3042</b>	<b>140x83xH45 cm</b>	<b>Reversed</b>	
Oak			
			<b>1.322</b>



<b>2-3045</b>	<b>102x90xH45 cm</b>		
Oak			<b>1.322</b>

Surcharge - Shelf in laminate

White  
Laminate (HPL)

Coloured  
Laminate (HPL)

<b>2-3031</b>	For model 2-3030	<b>241</b>	<b>264</b>
<b>2-3036</b>	For model 2-3035	<b>241</b>	<b>264</b>
<b>2-3041</b>	For model 2-3040	<b>278</b>	<b>302</b>
<b>2-3043</b>	For model 2-3042	<b>278</b>	<b>302</b>
<b>2-3046</b>	For model 2-3045	<b>278</b>	<b>302</b>

### PRODUCT HIGHLIGHTS

- Model 2-3030: W 17 kg / CBM 0,10
- Model 2-3035: W 22 kg / CBM 0,14
- Model 2-3040 / 2-3042: W 30 kg / CBM 0,19
- Model 2-3045: W 30 kg / CBM 0,19



## C2 - COFFEE TABLES

Design: Herman Studio

### Table top and legs in solid oak

Oak/Whitepig.  
matt lacquer

Oak  
Black lacquer

Ø50



**3-3601** Ø50xH43,5 cm

Oak

**471**

**471**

Ø80



**3-3607** Ø80xH47,5 cm

Oak

**712**

**712**

### PRODUCT HIGHLIGHTS

- Model 2-3601: W 4,75 kg / CBM 0,03
- Model 2-3607: W 6 kg / CBM 0,04

Model 3-3601



Model 3-3607

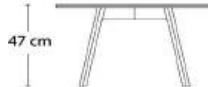



## C6 - COFFEE TABLE

Design: byKATO

Tabletop

Oak Veneer  
Whitepig. matt lacquer

**2-3450 140x50xH42 cm**

Metal frame - Black epoxy lacquered

**724**

140

50

### PRODUCT HIGHLIGHTS

- Model 3-3450: W 20 kg / CBM 0,10

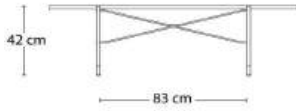



# EVOKE - COFFEE TABLES

Design: Says Who

Ø55



80

80



## Table top

Cream  
Marble

**2-36020213**      **Ø55xH45 cm**

Legs: Oak/Whitepigmented matt lacquer

**264**

**2-36010213**      **80x80xH40 cm**

Legs: Oak/Whitepigmented matt lacquer

**483**

### PRODUCT HIGHLIGHTS

- Model 2-36020213: W 19 kg / CBM 0,05
- Model 2-36010213: W 46 kg / CBM 0,10

Model 3-36020213

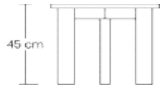

Model 3-36010213

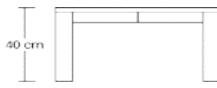

# CHAIRS



## FABRIC OVERVIEW - CHAIRS

### FABRIC GROUP 1



Cura - Gabriel



Renewed Loop - Gabriel



Xtreme - Camira

### FABRIC GROUP 2

Reflect - Kvadrat

Grain - Gabriel



Cyber - Gabriel



Step Melange - Gabriel



Select - Gabriel



Fame - Gabriel



Crisp - Gabriel



Remix - Kvadrat

### FABRIC GROUP 3

Illusion 3.0 - Nevotex

Illusion 3.0 Full grain - Nevotex



Hero - Kvadrat



Capture - Gabriel



Passion - Gabriel



Focus Royal - Gabriel



Mood - Gabriel



Re-wool - Kvadrat

### FABRIC GROUP 4



Hero Heather - Kvadrat



Canvas - Kvadrat

Nobel - Gabriel

### FABRIC GROUP 5



Fiord - Kvadrat



Steelcut Trio - Kvadrat



Divina - Kvadrat



Divina Melange - Kvadrat



Hallingdal 65 - Kvadrat

Comfort - Gabriel

Sydney leather - Camo (Black / Cognac)



Certified with EU Ecolabel. For more information, please visit the website of the fabric manufacturer.

Mood is EU Ecolabel certified with the following fabrics.



# AC2 - CHAIRS

Design: byKATO

## BASE/LEGS (AND SEAT)



Oak

Whitepig. matt lacquer



Oak

Clear matt lacquer



Oak

Black matt lacquer



Oak

Smoked matt lacquer



Beech

Whitepig. matt lacquer



Beech

Black matt lacquer



Beech

Smoked matt lacquer



Beech

Grey RAL7042



Beech

Green RAL7033

## UPHOLSTERY - PU LEATHER: Black or Brown



Black

PU Leather



Brown

PU Leather

## UPHOLSTERY - LEATHER: Standard leather - Black or Cognac



Black

Leather



Cognac

Leather

## PAPER WEAVE



Veneer seat

with paper weave

## UPHOLSTERY - FABRIC: See page 92 for fabric groups



## AC2 - CHAIR

Design: byKATO

Frame	Oak Lacquer	Beech Lacquer/Paint.
-------	----------------	-------------------------

### 2-803 B58xD53xH74 cm

Chair with seat in oak veneer

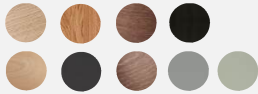

375

302

### 2-805 B58xD53xH74 cm

Chair with upholstered seat

PU leather: Black / Brown



398

337

Standard leather: Black / Cognac



471

398

Seat in paper weave \*



531

\* Only available in whitepigmented matt lacquer and clear matt lacquer

### 2-805- B58xD53xH74 cm

Chair with upholstered seat - Fabric group 1\*

471

398

Surcharge Fabric group\*  
(Fabric overview p. 92)

Gr. 2

Gr. 3

Gr. 4\*\*

Gr. 5

19

24

42

54

\* Minimum order: 4 chairs

### AC2 chair in customized RAL color

Project surcharge: painting of chairs in customized RAL color of your choice

1.907

Frame	Oak /hitepig. matte lac	Oak Matt Lacquer
-------	----------------------------	---------------------

### 2-807 B58xD53xH74 cm

Chair with upholstered seat and back - Standard leather: Black



542

542

Chair with upholstered seat and back - Standard leather: Cognac



542

### Surcharge - Loctite reinforcing adhesive, 5 ml

Recommended for seat mounting during intensive use to ensure extra durability.

24

### Frame colour

Oak / Lacquer

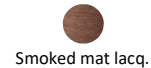

Beech / Lacquer



### PRODUCT HIGHLIGHTS

- W 6 kg / CBM 0,18 (Not stackable) Colli 2 pcs.

- Possibility of seats with fire resistant foam (CMHR) for larger projects

- Approved L1 test (General use) and meets the requirements of EN 16139:2013 Furniture – Strength, durability and safety

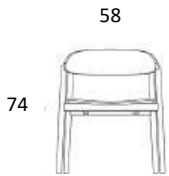

58



53







## ANCH - CHAIR

Design: Ari Kanerva

Frame Oak  
Lacquer

### 2-900 B53xD48xH77 cm

Chair with seat in oak veneer



363

### 2-910 B53xD48xH77 cm

Chair with upholstered seat

Standard leather: Black / Cognac



471

### 2-9003- B53xD48xH77 cm

Chair with upholstered seat - Fabric group 1\*

483

Surcharge Fabric group* (Fabric overview p. 92)	Gr. 2	Gr. 3	Gr. 4**	Gr. 5
	19	24	42	54

\* Minimum order: 4 chairs

### Anch chair in customized RAL color

Project surcharge: painting of chairs in customized RAL color of your choice

1.907

### Frame colour

Oak / Lacquer

 Whitepig. matt lacq.

 Clear matt lacquer

 Black matt lacquer

 Smoked mat lacq.

### PRODUCT HIGHLIGHTS

- W 5,3 kg / CBM 0,10 Colli 4 pcs.
- Stackable up to: 6 chairs (veneer seat) / 4 chairs (upholstered seat)
- Comfortable seating
- Classic chair with a clean Scandinavian design
- Padded seat available in many colors and materials
- Approved L1 test (General use) and meets the requirements of EN 16139:2013 Furniture – Strength, durability and safety

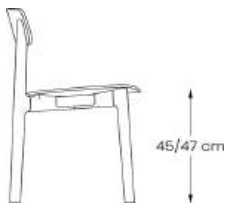

53



77



48

# DRY - CHAIRS

Design: Komplot

## SHELL COLOURS - GROUP 1



Black  
RAL 9005



Sandy Grey  
NCS 5502Y

## ARMRESTS



Black Plastic  
RAL 9005

## SHELL COLOURS - GROUP 2



Dark Petrol  
NCS 7010 B10G



Dusty Olive  
RAL 7009



Terracotta  
RAL 8002



Warm Charcoal  
RAL 7022

## FRAME COLOURS - GROUP 1



Black  
RAL 9005



Sandy Grey  
NCS 5502Y



Chrome

(Dry Outdoor - Only black frame)

## FRAME COLOURS - GROUP 2



Dark Petrol  
NCS 7010 B10G



Dusty Olive  
RAL 7009



Terracotta  
RAL 8002



Warm Charcoal  
RAL 7022





## DRY - CHAIR

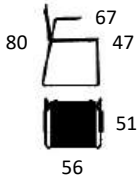
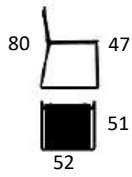

Design: Komplot



Frame	Frame colour Gr. 1	Frame colour Gr. 2
-------	-----------------------	-----------------------



### D1000

#### Shell in PUR

Shell colour gr. 1		<b>425</b>	<b>439</b>
Shell colour gr. 2		<b>439</b>	<b>453</b>

### D1050

#### Shell in PUR

Shell colour gr. 1		<b>542</b>	<b>556</b>
Shell colour gr. 2		<b>556</b>	<b>568</b>

### Surcharge

Linking device integrated in seat	<b>15</b>
Linking device integrated in the frame (only D1000 chrome)	<b>53</b>
Felt glides, set	<b>8</b>
Row linking device (Only for chairs without armrests)	<b>8</b>
Row linking device with felt (Only for chairs without armrests)	<b>14</b>

### Frame colour

Grp. 1

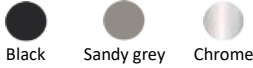

Grp. 2



### PRODUCT HIGHLIGHTS

- Passed L2 test (extreme use)
- Adapts to the shape of the body providing both support and comfort
- Sound-absorbing material
- Available with linking device (under seat or integrated in the frame)
- Armchairs can hang on the edge of the table
- Available with chair hanger
- Can stack up to 15 high on the floor
- Can stack up to 20 chairs on the trolley
- Please be aware that hard and incorrect use and handling of the chair in connection with stacking can cause wear marks and scratches
- Easy to clean, can withstand ethanol-based disinfectants
- Soft-touch surface and solution dyed material
- Weight: Dry 5,7 kg.
- Weight: Dry armchair 6,5 kg.



# DRY - BAR STOOL

Design: Komplot

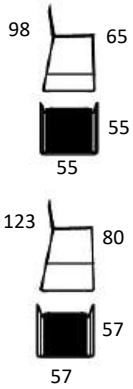

Frame	Frame colour
	Gr. 1
<b>DB1175</b>	
<b>Shell in PUR</b>	
Shell colour gr. 1	620
Shell colour gr. 2	632
<b>DB1276</b>	
<b>Shell in PUR</b>	
Shell colour gr. 1	646
Shell colour gr. 2	659
<b>Surcharge</b>	
Felt glides, set	8

Frame colour
Grp. 1
Black
Chrome

## PRODUCT HIGHLIGHTS

- Adapts to the shape of the body providing both support and comfort
- Sound-absorbing material
- Available with chair hanger
- Can stack up to 4 high on the floor
- Please be aware that hard and incorrect use and handling of the chair in connection with stacking can cause wear marks and scratches
- Easy to clean, can withstand ethanol-based disinfectants
- Soft-touch surface and solution dyed material
- Weight: Dry barchair low 7,5 kg.
- Weight: Dry barchair high 8 kg.



## DRY OUTDOOR - CHAIR

Design: Komplot

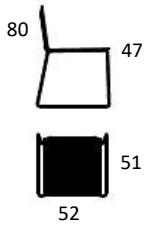

Frame

Frame colour  
Black

### DO1000

#### Shell in PUR

Shell colour gr. 1



425

Shell colour gr. 2



439

Frame colour



Black

### PRODUCT HIGHLIGHTS

- Weatherproof materials
- Molds to your body
- Providing both support and comfort
- Soft-touch surface
- Durable and versatile
- Can stack up to 15 chairs
- Please be aware that hard and incorrect use and handling of the chair in connection with stacking can cause wear marks and scratches
- Shell available in 7 colors
- Easy to clean, withstands disinfection
- Soft-touch surface and solution dyed material
- Passed L2 test (extreme use)





# HC1 - BAR STOOL

Design: Anne Qvist



Legs	Oak/Whitepig. Matt lacq. Oak/Matt lacquer	Oak/Black Lacquer Oak/Smoked matt lacq.
Footrest	Brushed steel	Black metal

## Height 67 cm



Legs in Oak/Whitepig. matt lacquer

<b>0-880L0302</b>	<b>B39xD32xH67 cm</b>		<b>337</b>
Veneer seat - Oak/whitepig.			
<b>0-880L0303</b>	<b>B39xD32xH67</b>		<b>375</b>
Aston PU leather seat - Black			



Legs in Oak/Clear matt lacquer

<b>0-880L0404</b>	<b>B39xD32xH67</b>		<b>337</b>
Veneer seat - Oak/Clear matt lacq.			
<b>0-880L0403</b>	<b>B39xD32xH67</b>		<b>375</b>
Aston PU leather seat - Black			

Legs in Oak/Black matt lacquer

<b>0-880L0101</b>	<b>B39xD32xH67</b>		<b>337</b>
Veneer seat - Oak/Black			
<b>0-880L0103</b>	<b>B39xD32xH67</b>		<b>375</b>
Aston PU leather seat - Black			

Legs in Oak/Smoked matt lacquer

<b>0-880L0505</b>	<b>B39xD32xH67</b>		<b>337</b>
Veneer seat - Oak/Smoked			
<b>0-880L0503</b>	<b>B39xD32xH67</b>		<b>375</b>
Aston PU leather seat - Black			





<b>0-881L-</b>	<b>B39xD32xH67</b>		<b>376</b>	<b>376</b>
Upholstered seat - Fabric group 1*				
Surcharge Fabric group* (Fabric overview p. 92)	Gr. 2	Gr. 3	Gr. 4	Gr. 5
	19	24	42	54

\* Minimum order: 4 chairs

## Mounting

0-888 - Mounting for 1 chair	<b>31</b>
------------------------------	-----------

## Frame colour

Oak / Lacquer				
	Whitepig. matt lacquer	Clear matt lacquer	Black matt lacquer	Smoked matt lacq.

## PRODUCT HIGHLIGHTS

- Model 0-880 W 3,5 kg CBM 0,18 (Not stackable)
- Chair glides with and without included
- The HC1 chair fulfils the requirements in EN 1022:2005 and EN 16139:2013. Furniture - Strength, durability and safety.







# HC1 - BAR STOOL

Design: Anne Qvist



Legs	Oak/Whitepig. Matt lacq. Oak/Matt lacquer	Oak/Black Lacquer Oak/Smoked matt lacq.
Footrest	Brushed steel	Black metal

## Height 80 cm



### Legs in Oak/Whitepig. matt lacquer

<b>0-885H0302</b>	<b>B39xD35xH80 cm</b>		<b>349</b>
Veneer seat - Oak/whitepig.			
<b>0-885H0303</b>	<b>B39xD35xH80 cm</b>		<b>386</b>
Aston PU leather seat - Black			



### Legs in Oak/Clear matt lacquer

<b>0-885H0404</b>	<b>B39xD35xH80 cm</b>		<b>349</b>
Veneer seat - Oak/Clear matt lacq.			
<b>0-885H0403</b>	<b>B39xD35xH80 cm</b>		<b>386</b>
Aston PU leather seat - Black			

### Legs in Oak/Black matt lacquer

<b>0-885H0101</b>	<b>B39xD35xH80 cm</b>		<b>349</b>
Veneer seat - Oak/Black			
<b>0-885H0103</b>	<b>B39xD35xH80 cm</b>		<b>386</b>
Aston PU leather seat - Black			





### Legs in Oak/Smoked matt lacquer

<b>0-885H0505</b>	<b>B39xD35xH80 cm</b>		<b>349</b>
Veneer seat - Oak/Smoked			
<b>0-885H0503</b>	<b>B39xD35xH80 cm</b>		<b>386</b>
Aston PU leather seat - Black			

<b>0-886H-</b>	<b>B39xD35xH80 cm</b>		<b>388</b>	<b>388</b>
Upholstered seat - Fabric group 1*				
Surcharge Fabric group* (Fabric overview p. 92)	Gr. 2	Gr. 3	Gr. 4	Gr. 5
	19	24	42	54

\* Minimum order: 4 chairs

<b>Mounting</b>	
0-888 - Mounting for 1 chair	<b>31</b>

<b>Frame colour</b>				
Oak / Lacquer	Whitepig. matt lacquer	Clear matt lacquer	Black matt lacquer	Smoked matt lacq.

## PRODUCT HIGHLIGHTS

- Model 0-885: W 4 kg / CBM 0,18 (Not stackable)
- Chair glides with and without included
- The HC1 chair fulfils the requirements in EN 1022:2005 and EN 16139:2013. Furniture - Strength, durability and safety.





# HC2 - BAR STOOL

Design: byKATO

Frame

Black  
Structure painted frame

## Height 65 cm

**0-860L0213-FSC B41xD30xH65 cm**

Seat in oak/Whitepig. matt lacquer



229

**0-860L0509-FSC B41xD30xH65 cm**

Seat in ash/Black matt lacquer



229

## Height 79 cm

**0-865H0213-FSC B44xD33xH79 cm**

Seat in oak/Whitepig. matt lacquer



241

**0-865H0509-FSC B44xD33xH79 cm**

Seat in ash/Black matt lacquer



241

## Mounting

0-888 - Mounting for 1 chair

31

## Frame colour



Black structure painted

## PRODUCT HIGHLIGHTS

- Model 0-860L: W 5 kg / CBM 0,10 (Not stackable)
- Model 0-860H: W 5,25 kg / CBM 0,10 (Not stackable)
- Felt floor protector mounted
- Seat size: 39x24 cm
- Delivered "Knock down"
- The HC2 chair fulfils the requirements in EN 1022:2005 and EN 16139:2013. Furniture - Strength, durability and safety.

Model 0-860L



Model 0-865H

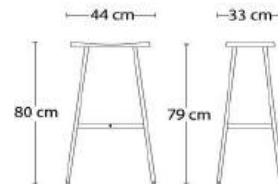

# MOOD - CHAIRS

Design: Hans-Thyge & Co.

## SHELL COLOURS - GROUP 1



Black  
RAL 9005



Light Grey  
RAL 7042

## ARMRESTS



Black PP  
RAL 9005

## SHELL COLOURS - GROUP 2



Dark Petrol  
NCS 7010 B10G



Dusty Green  
NCS S6010 G10Y

## FRAME COLOURS - GROUP 1



Black  
RAL 9005



Chrome

## FRAME COLOURS - GROUP 2



Dark Petrol  
NCS 7010 B10G



Dusty Green  
NCS S6010 G10Y



18 chairs of the Mood collection are certified according to the EU Ecolabel  
Winner of the German Design Award 2019 - Excellent Product Design.



# MOOD 4-LEGS - CHAIR

Design: Hans-Thyge & Co.

Frame	Frame colour	
	Gr. 1	Gr. 2

## MO1200

### Shell in PP

Shell colour gr. 1		<b>220</b>	<b>234</b>
Shell colour gr. 2		<b>234</b>	<b>246</b>

## MO1205

### Upholstered seat pad - Fabric group 1\*

Shell colour gr. 1		<b>332</b>	<b>344</b>
Shell colour gr. 2		<b>344</b>	<b>358</b>

Surcharge Fabric group* (Fabric overview p. 92)	Gr. 2	Gr. 3	Gr. 4	Gr. 5
	<b>19</b>	<b>24</b>	<b>42</b>	<b>54</b>

## MO1210

### Fully upholstered - Fabric group 1\*

		<b>505</b>	<b>517</b>	
Surcharge Fabric group* (Fabric overview p. 92)	Gr. 2	Gr. 3	Gr. 4	Gr. 5
	<b>29</b>	<b>53</b>	<b>105</b>	<b>173</b>

\* Minimum order: 4 chairs

## Surcharge

Felt glides, set	<b>14</b>
Stacking shield	<b>49</b>

## Frame colour

Grp. 1		
	Black	Chrome
Grp. 2		
	Dark petrol Petrol	Dusty Green

## PRODUCT HIGHLIGHTS

- EU Ecolabel certified (black shell)
- Passed L2 (extreme use)
- Shell made from 100% upcycled black PP (polypropylene)
- The metal frame is made from 45% steel
- Disposal: can easily be separated in each material
- The dotted texture reduces marks and has an anti-slippery effect
- Armchairs can hang on the edge of the table
- Available with chair hanger
- Tilt glides with acoustic properties
- Can stack up to 10 high on the floor (w/o armrests)
- Can stack up to 20 chairs on the trolley
- Please be aware that hard and incorrect use and handling of the chair in connection with stacking can cause wear marks and scratches
- Weight: Mood 4-Legs: 4,8 kg
- Weight: Mood 4-Legs armchair: 5,3 kg

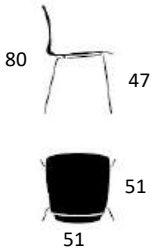



## MOOD 4-LEGS - ARM CHAIR

Design: Hans-Thyge & Co.

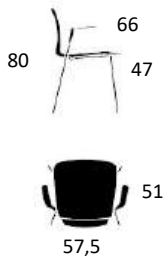

Frame	Frame colour Gr. 1
-------	-----------------------

### MO1250

#### Shell in PP

Shell colour gr. 1		<b>307</b>
Shell colour gr. 2		<b>320</b>

### MO1255

#### Upholstered seat pad - Fabric group 1\*

Shell colour gr. 1		<b>419</b>
Shell colour gr. 2		<b>442</b>

Surcharge Fabric group* (Fabric overview p. 92)	Gr. 2 <b>19</b>	Gr. 3 <b>24</b>	Gr. 4 <b>42</b>	Gr. 5 <b>54</b>
--	--------------------	--------------------	--------------------	--------------------

### MO1260

#### Fully upholstered - Fabric group 1\*

**592**

Surcharge Fabric group* (Fabric overview p. 92)	Gr. 2 <b>29</b>	Gr. 3 <b>53</b>	Gr. 4 <b>105</b>	Gr. 5 <b>173</b>
--	--------------------	--------------------	---------------------	---------------------

\* Minimum order: 4 chairs

### Surcharge

Felt glides, set	<b>14</b>
Stacking shield	<b>49</b>

### Frame colour

Grp. 1		
	Black	Chrome

For larger projects, there is a option of frame colours that match other chairs - please inquire for price

### PRODUCT HIGHLIGHTS

- EU Ecolabel certified (black shell)
- Passed L2 (extreme use)
- Shell made from 100% upcycled black PP (polypropylene)
- The metal frame is made from 45% steel
- Disposal: can easily be separated in each material
- The dotted texture reduces marks and has an anti-slippery effect
- Armchairs can hang on the edge of the table
- Available with chair hanger
- Tilt glides with acoustic properties
- Can stack up to 10 high on the floor (w/o armrests)
- Can stack up to 20 chairs on the trolley
- Please be aware that hard and incorrect use and handling of the chair in connection with stacking can cause wear marks and scratches
- Weight: Mood 4-Legs: 4,8 kg
- Weight: Mood 4-Legs armchair: 5,3 kg





# MOOD TUBE - CHAIR

Design: Hans-Thyge & Co.

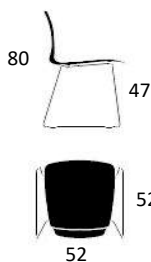

Frame	Frame colour Gr. 1
-------	-----------------------

<b>MO1000</b>		
<b>Shell in PP</b>		
Shell colour gr. 1		<b>246</b>
Shell colour gr. 2		<b>258</b>

<b>MO1005</b>		
<b>Upholstered seat pad - Fabric group 1*</b>		
Shell colour gr. 1		<b>369</b>
Shell colour gr. 2		<b>381</b>
Surcharge Fabric group* (Fabric overview p. 92)	Gr. 2    Gr. 3    Gr. 4    Gr. 5	
	<b>19      24      42      54</b>	

<b>MO1010</b>		
<b>Fully upholstered - Fabric group 1*</b>		<b>529</b>
Surcharge Fabric group* (Fabric overview p. 92)	Gr. 2    Gr. 3    Gr. 4    Gr. 5	
	<b>31      53      105    173</b>	

\* Minimum order: 4 chairs

<b>Surcharge</b>		
Felt glides, set		<b>8</b>
Stacking shield		<b>49</b>
Linking device integrated in the frame (chairs w/o armrest chrome)		<b>53</b>
Row linking device (Only for chairs without armrests)		<b>8</b>
Row linking device with felt (Only for chairs without armrests)		<b>14</b>

<b>Frame colour</b>	
Grp. 1	Black    Chrome

For larger projects, there is a option of frame colours that match other chairs - please inquire for price

## PRODUCT HIGHLIGHTS

- Shell made from 100% upcycled black PP (polypropylene)
- The metal frame is made from 45% steel
- Disposal: can easily be separated in each material
- The dotted texture reduces marks and has an anti-slippery effect
- Armchairs can hang on the edge of the table
- Available with chair hanger
- Linking device possible (only MO1000, MO1005, MO1010)
- Can stack up to 10 high on the floor (w/o armrests)
- Can stack up to 20 chairs on the trolley
- Please be aware that hard and incorrect use and handling of the chair in connection with stacking can cause wear marks and scratches
- Weight: Mood Tube: 5,4 kg.
- Weight: Mood Tube armchair: 6 kg.



## MOOD LOW - BAR CHAIR

Design: Hans-Thyge & Co.

Frame	Frame colour Gr. 1
-------	-----------------------

### MOB1075

#### Shell in PP

Shell colour gr. 1  **358**

Shell colour gr. 2  **369**

### MOB1175

#### Upholstered seat pad - Fabric group 1\*

Shell colour gr. 1  **468**

Shell colour gr. 2  **480**

Surcharge Fabric group* (Fabric overview p. 92)	Gr. 2	Gr. 3	Gr. 4	Gr. 5
	<b>19</b>	<b>24</b>	<b>42</b>	<b>54</b>

### MOB1275

#### Fully upholstered - Fabric group 1\*

**641**

Surcharge Fabric group* (Fabric overview p. 92)	Gr. 2	Gr. 3	Gr. 4	Gr. 5
	<b>29</b>	<b>53</b>	<b>105</b>	<b>173</b>

\* Minimum order: 4 chairs

### Surcharge

Felt glides, set **8**

Stacking shield **49**

### Frame colour

Grp. 1



For larger projects, there is a option of frame colours that match other chairs - please inquire for price

### PRODUCT HIGHLIGHTS

- Shell made from 100% upcycled black PP (polypropylene)
- The metal frame is made from 45% steel
- Disposal: can easily be separated in each material
- The dotted texture reduces marks and has an anti-slippery effect
- Available with chair hanger
- Can stack up to 4 high on the floor
- Please be aware that hard and incorrect use and handling of the chair in connection with stacking can cause wear marks and scratches
- Weight: Mood Bar low: 6,2 kg.
- Weight: Mood Bar high 6,5 kg.

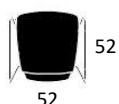
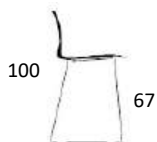



# MOOD HIGH - BAR CHAIR

Design: Hans-Thyge & Co.

Frame

Frame colour  
Gr. 1

## MOB1076

### Shell in PP

Shell colour gr. 1



381

Shell colour gr. 2



393

## MOB1176

### Upholstered seat pad - Fabric group 1\*

Shell colour gr. 1



492

Shell colour gr. 2



505

Surcharge Fabric group\*  
(Fabric overview p. 92)

Gr. 2

Gr. 3

Gr. 4

Gr. 5

19

24

42

54

## MOB1276

### Fully upholstered - Fabric group 1\*

664

Surcharge Fabric group\*  
(Fabric overview p. 92)

Gr. 2

Gr. 3

Gr. 4

Gr. 5

29

53

105

173

\* Minimum order: 4 chairs

## Surcharge

Felt glides, set

8

Stacking shield

49

## Frame colour

Grp. 1



Black



Chrome

For larger projects, there is a option of frame colours that match other chairs - please inquire for price

## PRODUCT HIGHLIGHTS

- Shell made from 100% upcycled black PP (polypropylene)
- The metal frame is made from 45% steel
- Disposal: can easily be separated in each material
- The dotted texture reduces marks and has an anti-slippery effect
- Available with chair hanger
- Can stack up to 4 high on the floor
- Please be aware that hard and incorrect use and handling of the chair in connection with stacking can cause wear marks and scratches
- Weight: Mood Bar low: 6,2 kg.
- Weight: Mood Bar high 6,5 kg.

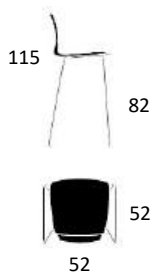



## MOOD CONFERENCE - CHAIR

Design: Hans-Thyge & Co.

Frame Frame colour  
Black

### MO1400

#### Shell in PP

Shell colour gr. 1  529

Shell colour gr. 2  542

### MO1405

#### Upholstered seat pad - Fabric group 1\*

Shell colour gr. 1  641

Shell colour gr. 2  653

Surcharge Fabric group* (Fabric overview p. 92)	Gr. 2	Gr. 3	Gr. 4	Gr. 5
	<b>19</b>	<b>24</b>	<b>42</b>	<b>54</b>

### MO1410

#### Fully upholstered - Fabric group 1\*

**812**

Surcharge Fabric group* (Fabric overview p. 92)	Gr. 2	Gr. 3	Gr. 4	Gr. 5
	<b>29</b>	<b>53</b>	<b>105</b>	<b>173</b>

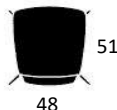
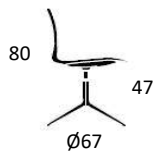

### MO1450

#### Shell in PP

Shell colour gr. 1  627

Shell colour gr. 2  641

### MO1455

#### Upholstered seat pad - Fabric group 1\*

Shell colour gr. 1  739

Shell colour gr. 2  751

Surcharge Fabric group* (Fabric overview p. 92)	Gr. 2	Gr. 3	Gr. 4	Gr. 5
	<b>19</b>	<b>24</b>	<b>42</b>	<b>54</b>

### MO1460

#### Fully upholstered - Fabric group 1\*

**912**

Surcharge Fabric group* (Fabric overview p. 92)	Gr. 2	Gr. 3	Gr. 4	Gr. 5
	<b>29</b>	<b>53</b>	<b>105</b>	<b>173</b>

\* Minimum order: 4 chairs

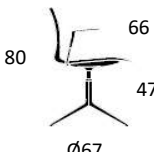

#### Frame colour

Grp. 1



Black

#### PRODUCT HIGHLIGHTS

- EU Ecolabel certified (black shell)
- Passed L2 (extreme use)
- Shell made from 100% upcycled black PP (polypropylene)
- Disposal: can easily be separated in each material
- The dotted texture reduces marks and has an anti-slippery effect
- Armchairs can hang on the edge of the table
- The chair has an integrated tilt system
- Armrests can be retrofitted
- Weight: Mood Conference: 7,7 kg.
- Weight: Mood Conference armchair: 8,7 kg.





# MOOD WOOD - CHAIR

Design: Hans-Thyge & Co.

Frame Frame colour  
Gr. 1

## MO1300

### Shell in PP

Shell colour gr. 1  419

Shell colour gr. 2  431

## MO1305

### Upholstered seat pad - Fabric group 1\*

Shell colour gr. 1  529

Shell colour gr. 2  542

Surcharge Fabric group* (Fabric overview p. 92)	Gr. 2	Gr. 3	Gr. 4	Gr. 5
	<b>19</b>	<b>24</b>	<b>42</b>	<b>54</b>

## MO1310

### Fully upholstered - Fabric group 1\*

**702**

Surcharge Fabric group* (Fabric overview p. 92)	Gr. 2	Gr. 3	Gr. 4	Gr. 5
	<b>29</b>	<b>53</b>	<b>105</b>	<b>173</b>

\* Minimum order: 4 chairs

## Surcharge

Felt glides, set

**8**

## Frame colour

Grp. 1

 Oak/Whitepigm. matt lacquer

 Oak/Black matt lacquer

## PRODUCT HIGHLIGHTS

- Passed L2 (extreme use)
- Shell made from 100% upcycled black PP (polypropylene)
- The wooden frame comes from FSC certified forests
- Disposal: can easily be separated in each material
- Metal frame is supplied in shell colour/black when fully upholstered
- The dotted texture reduces marks and has an anti-slippery effect
- Weight: Mood Wood: 5,4 kg.

81

48



49

43



# MOOD CLASSIC - CHAIR

Design: Hans-Thyge & Co.

Frame

Frame colour  
Gr. 1

## MOC1600

### Shell in PP

Shell colour gr. 1



603

Shell colour gr. 2



615

## MOC1605

### Upholstered seat pad - Fabric group 1\*

Shell colour gr. 1



714

Shell colour gr. 2



727

Surcharge Fabric group\*  
(Fabric overview p. 92)

Gr. 2

Gr. 3

Gr. 4

Gr. 5

19

24

42

54

## MOC1610

### Fully upholstered - Fabric group 1\*

886

Surcharge Fabric group\*  
(Fabric overview p. 92)

Gr. 2

Gr. 3

Gr. 4

Gr. 5

29

53

105

173

\* Minimum order: 4 chairs

## Surcharge

Felt glides, set

8

## Frame colour

Grp. 1



Oak/Black matt lacquer

## PRODUCT HIGHLIGHTS

- Passed L1
- Shell made from 100% upcycled black PP (polypropylene)
- The wooden frame comes from FSC certified forests
- Disposal: can easily be separated in each material
- The dotted texture reduces marks and has an anti-slippery effect
- Weight: Mood Classic: 6,7 kg.





## MOOD LEARN - CHAIR

Design: Hans-Thyge & Co.

Frame	Frame colour Gr. 1
-------	-----------------------

### MOL1500

#### Shell in PP

Shell colour gr. 1		344
--------------------	--	-----

Shell colour gr. 2		358
--------------------	--	-----

### MOL1505

#### Upholstered seat pad - Fabric group 1\*

Shell colour gr. 1		456
--------------------	--	-----

Shell colour gr. 2		468
--------------------	--	-----

Surcharge Fabric group* (Fabric overview p. 92)	Gr. 2	Gr. 3	Gr. 4	Gr. 5
	19	24	42	54

### MOL1510

#### Fully upholstered - Fabric group 1\*

615

Surcharge Fabric group* (Fabric overview p. 92)	Gr. 2	Gr. 3	Gr. 4	Gr. 5
	29	53	105	173

\* Minimum order: 4 chairs

### Surcharge

Glides	0
Wheels with brakes when not strained, set	14
Gas-lift, H 47-65 cm	14
Footrest (loose)	71

### Frame colour

Grp. 1

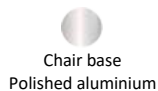

### PRODUCT HIGHLIGHTS

- EU Ecolabel certified (black shell)
- Passed L2 (extreme use)
- Shell made from 100% upcycled black PP (polypropylene)
- Disposal: can easily be separated in each material
- Metal frame is supplied in shell colour/black when fully upholstered
- The dotted texture reduces marks and has an anti-slippery effect
- Armchairs can hang on the edge of the table
- Available with chair hanger
- The chair has an integrated tilt system
- Weight: Mood Learn: 8,1 kg.
- Weight: Mood Learn w. footrest: 9,1 kg.
- Weight: Mood Learn armchair: 9,1 kg.





## MOOD LEARN - ARM CHAIR

Design: Hans-Thyge & Co.

Frame

Frame colour  
Gr. 1

### MOL1550

#### Shell in PP

Shell colour gr. 1



431

Shell colour gr. 2



442

### MOL1555

#### Upholstered seat pad - Fabric group 1\*

Shell colour gr. 1



542

Shell colour gr. 2



554

Surcharge Fabric group\*  
(Fabric overview p. 92)

Gr. 2

Gr. 3

Gr. 4

Gr. 5

19

24

42

54

### MOL1560

#### Fully upholstered - Fabric group 1\*

714

Surcharge Fabric group\*  
(Fabric overview p. 92)

Gr. 2

Gr. 3

Gr. 4

Gr. 5

29

53

105

173

\* Minimum order: 4 chairs

### Surcharge

Glides

0

Wheels with brakes when not strained, set

14

Gas-lift, H 47-65 cm

14

Footrest (loose)

71

### Frame colour

Grp. 1



Chair base  
Black aluminium



Chair base  
Polished aluminium

### PRODUCT HIGHLIGHTS

- EU Ecolabel certified (black shell)
- Passed L2 (extreme use)
- Shell made from 100% upcycled black PP (polypropylene)
- Disposal: can easily be separated in each material
- Metal frame is supplied in shell colour/black when fully upholstered
- The dotted texture reduces marks and has an anti-slippery effect
- Armchairs can hang on the edge of the table
- Available with chair hanger
- The chair has an integrated tilt system
- Weight: Mood Learn: 8,1 kg.
- Weight: Mood Learn w. footrest: 9,1 kg.
- Weight: Mood Learn armchair: 9,1 kg.





## MOOD LEARN - CHAIR

Design: Hans-Thyge & Co.

Frame

Frame colour  
Gr. 1

### MOLF1500

#### Shell in PP

Shell colour gr. 1



442

Shell colour gr. 2



456

### MOLF1505

#### Upholstered seat pad - Fabric group 1\*

Shell colour gr. 1



554

Shell colour gr. 2



566

Surcharge Fabric group\*  
(Fabric overview p. 92)

Gr. 2

Gr. 3

Gr. 4

Gr. 5

19

24

42

54

### MOLF1510

#### Fully upholstered - Fabric group 1\*

727

Surcharge Fabric group\*  
(Fabric overview p. 92)

Gr. 2

Gr. 3

Gr. 4

Gr. 5

29

53

105

173

\* Minimum order: 4 chairs

### Surcharge

Glides

0

Wheels with brakes when not strained, set

14

Footrest (loose)

71

### Frame colour

Grp. 1



Chair base  
Black aluminium



Chair base  
Polished aluminium

### PRODUCT HIGHLIGHTS

- EU Ecolabel certified (black shell)
- Passed L2 (extreme use)
- Shell made from 100% upcycled black PP (polypropylene)
- Disposal: can easily be separated in each material
- Metal frame is supplied in shell colour/black when fully upholstered
- The dotted texture reduces marks and has an anti-slippery effect
- Armchairs can hang on the edge of the table
- Available with chair hanger
- The chair has an integrated tilt system
- Weight: Mood Learn: 8,1 kg.
- Weight: Mood Learn w. footrest: 9,1 kg.
- Weight: Mood Learn armchair: 9,1 kg.



# PURE - CHAIRS

Design: Thore Lassen Design

## SHELL COLOURS - GROUP 1



Black  
RAL 9005



Sandy Grey  
NCS 5502Y

## SHELL COLOURS - GROUP 2



Dark Petrol  
NCS 7010 B10G



Dusty Olive  
RAL 7009



Terracotta  
RAL 8002



Warm Charcoal  
RAL 7022

## FRAME COLOURS - GROUP 1



Black  
RAL 9005



Sandy Grey  
NCS 5502Y



Chrome

## FRAME COLOURS - GROUP 2



Dark Petrol  
NCS 7010 B10G



Dusty Olive  
RAL 7009



Terracotta  
RAL 8002



Warm Charcoal  
RAL 7022





## PURE - CHAIR

Design: Thore Lassen Design



51

Frame	Frame colour Gr. 1	Frame colour Gr. 2		
<b>P1000</b>				
<b>Seat / back in PUR</b>				
Seat / back colour gr. 1		<b>341</b>	<b>356</b>	
Seat / back colour gr. 2		<b>356</b>	<b>371</b>	
<b>P1100</b>				
<b>Upholstered seat - Fabric group 1* / Back in PUR</b>				
Seat / back colour gr. 1		<b>392</b>	<b>407</b>	
Seat / back colour gr. 2		<b>407</b>	<b>422</b>	
Surcharge Fabric group* (Fabric overview p. 92)	Gr. 2 <b>19</b>	Gr. 3 <b>24</b>	Gr. 4 <b>42</b>	Gr. 5 <b>54</b>

\* Minimum order: 4 chairs

### Surcharge

Linking device - P1000 & P1100 only	<b>34</b>
Felt glides, set	<b>14</b>

### Frame colour

Grp. 1				
	Black	Sandy grey	Chrome	
Grp. 2				
	Dark petrol Petrol	Dusty Olive	Terracotta	Warm Charcoal
				0

### PRODUCT HIGHLIGHTS

- Passed L2 (extreme use)
- Sound absorbing material
- Tilt glides with acoustic properties
- Linking device is available
- Chair hanger is available
- Can stack up to 12 high on the floor
- Please be aware that hard and incorrect use and handling of the chair in connection with stacking can cause wear marks and scratches
- Easy to clean, can withstand ethanol-based disinfectants
- Soft-touch surface and solution dyed material
- Weight: Pure 5,5 kg.



# PURE - STOOL / BAR STOOL

Design: Thore Lassen Design

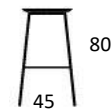

Frame		Frame colour Gr. 1
<b>PT1074</b>		
<b>Seat in PUR</b>		
Seat colour gr. 1		<b>215</b>
Seat back colour gr. 2		<b>220</b>
<b>PB1075</b>		
<b>Seat in PUR</b>		
Seat colour gr. 1		<b>276</b>
Seat back colour gr. 2		<b>292</b>
<b>PB1076</b>		
<b>Seat in PUR</b>		
Seat colour gr. 1		<b>303</b>
Seat back colour gr. 2		<b>319</b>
<b>Surcharge</b>		
Felt glides, set		<b>14</b>

Frame colour	
Grp. 1	Black            Chrome

For larger projects, a price can be requested if the same frame and shell color is desired

## PRODUCT HIGHLIGHTS

- Sound absorbing material
- Tilt glides with acoustic properties
- Can stack up to 10 high on the floor (Pure stool)
- Please be aware that hard and incorrect use and handling of the chair in connection with stacking can cause wear marks and scratches
- Easy to clean, can withstand ethanol-based disinfectants
- Soft-touch surface and solution dyed material
- Weight: Pure stool 3,5 kg.
- Weight: Pure Bar low 4,5 kg.
- Weight: Pure Bar high 5 kg.



# PURE X - CHAIR

Design: Thore Lassen Design

Frame Frame colour  
Gr. 1

## PX1000

### Seat / back in PUR

Seat / back colour gr. 1  393

Seat / back colour gr. 2  410

## PX1100

### Upholstered seat - Fabric group 1\* / Back in PUR

Back colour gr. 1  425

Back colour gr. 2  441

Surcharge Fabric group\* (Fabric overview p. 92) 

Gr. 2	Gr. 3	Gr. 4	Gr. 5
19	24	42	54

41-54



Ø62

50



49

## PXF1000

### Seat / back in PUR

Seat / back colour gr. 1  483

Seat / back colour gr. 2  498

## PXF1100

### Upholstered seat - Fabric group 1\* / Back in PUR

Back colour gr. 1  532

Back colour gr. 2  547

Surcharge Fabric group\* (Fabric overview p. 92) 

Gr. 2	Gr. 3	Gr. 4	Gr. 5
19	24	42	54

56-82



Ø62

50



49

\* Minimum order: 4 chairs

## Surcharge

Glides	0
Wheels with brakes when not strained, set	14
Gas-lift XL, height 50-68 cm - PX1000 & PX1100 only	14
Tilt mechanism - not adjustable (height increased with 25 mm)	44
Loose footrest	71

## Frame colour

Grp. 1

 Chair base  
Black aluminium  
Black bagrest bar

 Chair base  
Polished aluminium  
Black bagrest bar

## PRODUCT HIGHLIGHTS

- Sound absorbing material
- Chair hanger is available
- Alu base - polished or matt black lacquered
- Back hanger matt black lacquered
- Tilt system is available
- Footrest and glides are available
- Adjustable seat height - 3 different heights
- Easy to clean, can withstand ethanol-based disinfectants
- Soft-touch surface and solution dyed material
- Weight: Pure X 8 kg
- Weight: Pure X w. footrest 9 kg

# RAIL - CHAIRS

Design: Søren Nielsen & Thore Lassen

## SEAT / BACK - GROUP 1



Birch

Clear matt lacquer

## SEAT / BACK - GROUP 2



Ash

Black matt lacquer

## FRAME COLOURS - GROUP 1



Black

RAL 9005

## FRAME COLOURS - GROUP 2



Chrome





## RAIL - CHAIR

Design: Søren Nielsen & Thore Lassen

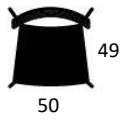

Frame		Frame colour Gr. 1	Frame colour Gr. 2
<b>R1000</b>			
<b>Seat / back in wood</b>			
Seat / back in birch clear matt lacquer		<b>446</b>	<b>446</b>
Seat / back in ash black matt lacquer		<b>461</b>	<b>461</b>
<b>R1100</b>			
<b>Upholstered seat - Fabric group 1* / back in wood</b>			
Back in birch clear matt lacquer		<b>492</b>	<b>492</b>
Back in ash black matt lacquer		<b>507</b>	<b>507</b>
Surcharge Fabric group* (Fabric overview p. 92)	Gr. 2 <b>19</b>	Gr. 3 <b>24</b>	Gr. 4 <b>42</b>
		Gr. 5 <b>54</b>	

\* Minimum order: 4 chairs

### Surcharge

Linking device - R1000 & R1100 only	<b>34</b>
Felt glides, set	<b>14</b>

### Frame colour

Grp. 1



Black

Grp. 2



Chrome

### PRODUCT HIGHLIGHTS

- Can stack up to 12 high on the floor
- Please be aware that hard and incorrect use and handling of the chair in connection with stacking can cause wear marks and scratches
- Available with chair hanger
- Available with linking device
- Available with seat upholstery
- Weight: Rail 4,5 kg.

# SCOPE - CHAIRS

Design: Hans-Thyge & Co.

## SEAT / BACK



Oak Whitetinted  
Lacquered



Oak  
Smoked lacquered



Oak  
Blacklacquered

## FRAME COLOURS



Black  
RAL 9005 Matt

## STETHOSCOPE



Black  
RAL 9005 Matt



Brass  
Lacquered



Zinc

## ARMREST (SCOPE LOUNGE & SCOPE ARMCHAIR)



Black  
RAL 9005 Matt





## SCOPE - CHAIR

Design: Hans-Thyge & Co.

Frame	Frame colour Black
-------	-----------------------

### SC1000

Seat / back in oak



364

### SC1010-

Upholstered seat - Fabric group 1\*

427

Back in Oak

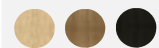

Surcharge Fabric group\*  
(Fabric overview p. 92)

Gr. 2

Gr. 3

Gr. 4

Gr. 5

19

24

42

54



52,5



47

### SC1110-

Upholstered seat and back - Fabric group 1\*

539

Surcharge Fabric group\*  
(Fabric overview p. 92)

Gr. 2

Gr. 3

Gr. 4

Gr. 5

29

53

105

173

\* Minimum order: 4 chairs

### Surcharge

Stethoscope in Brass / zinc, set

15

Felt glides, set

14

Linking device (SC-KOBLING)

24

### frame Colour

Gr. 1



Black

### PRODUCT HIGHLIGHTS

- Stethoscope 4 colours - Possibility for unique design
- Integrated felt pads - sound absorbing & protects upholstery
- Scope chair can stack 10 psc.
- Please be aware that hard and incorrect use and handling of the chair in connection with stacking can cause wear marks and scratches
- FSC certified oak
- Metal 50 % recycled
- Approved L2 test (extreme use)
- Weight 4,5 kg.



## SCOPE - ARMCHAIR

Design: Hans-Thyge & Co.

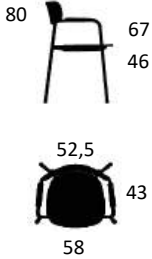

Frame	Frame colour Black
-------	-----------------------

### SC1050

Seat / back in oak / armrest in PUR

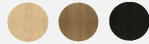

464

### SC1060-

Upholstered seat - Fabric group 1\*

Back in Oak / armrest in PUR

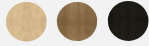

502

Surcharge Fabric group* (Fabric overview p. 92)	Gr. 2 19	Gr. 3 24	Gr. 4 42	Gr. 5 54
--	-------------	-------------	-------------	-------------

### SC1160-

Upholstered seat and back - Fabric group 1\*

627

Surcharge Fabric group* (Fabric overview p. 92)	Gr. 2 29	Gr. 3 53	Gr. 4 105	Gr. 5 173
--	-------------	-------------	--------------	--------------

\* Minimum order: 4 chairs

### Surcharge

Stethoscope in Brass / zinc, set	15
Felt glides, set	14
Linking device (SC-KOBLING)	24

### frame Colour

Gruppe 1



Black

### PRODUCT HIGHLIGHTS

- Stethoscope 4 colours - Possibility for unique design
- Integrated felt pads - sound absorbing & protects upholstery
- Scope chair can stack 10 pcs.
- Please be aware that hard and incorrect use and handling of the chair in connection with stacking can cause wear marks and scratches
- FSC Certified oak
- Metal 50% recycled
- Approved L2 test (extreme use)
- Weight: 5,3 kg.



## SCOPE STOOL / BAR STOOL

Design: Hans-Thyge & Co.

Frame

Frame colour  
Black

### SCT1074

Seat in oak

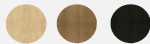

200

### SCT1274

Upholstered seat - Fabric group 1\*

288

Surcharge Fabric group* (Fabric overview p. 92)	Gr. 2	Gr. 3	Gr. 4	Gr. 5
	19	24	42	54

46,5



38,5

38,5

### SCB1075

Seat in oak

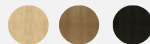

263

### SCB1275

Upholstered seat - Fabric group 1\*

351

Surcharge Fabric group* (Fabric overview p. 92)	Gr. 2	Gr. 3	Gr. 4	Gr. 5
	19	24	42	54

65,5



21



40,5

40,5

### SCB1076

Seat in oak

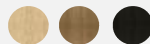

276

### SCB1276

Upholstered seat - Fabric group 1\*

364

Surcharge Fabric group* (Fabric overview p. 92)	Gr. 2	Gr. 3	Gr. 4	Gr. 5
	19	24	42	54

78



34



42

42

\* Minimum order: 4 chairs

### Surcharge

Felt glides, set

14

### Frame colour

Grp. 1



Black

### PRODUCT HIGHLIGHTS

- Stethoscope 4 colours - Possibility for unique design
- Integrated felt pads - sound absorbing & protects upholstery
- Scope Stool can stack 20 pcs. and 2 Scope bar
- Please be aware that hard and incorrect use and handling of the chair in connection with stacking can cause wear marks and scratches
- FSC Certified oak
- Metal 50% recycled
- Approved L2 test (extreme use)
- Weight: Scope Stool 2,5 kg. Bar low 4,3 kg. Bar high 4,5 kg.



## SCOPE - LOUNGECHAIR

Design: Hans-Thyge & Co.

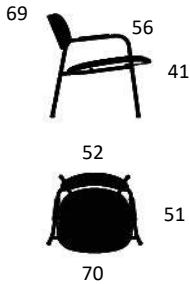

Frame	Frame colour Black
-------	-----------------------

<b>SCL1610</b>						
Upholstered seat - Fabric group 1*						<b>703</b>
Back in Oak						
Surcharge Fabric group* (Fabric overview p. 92)	Gr. 2	Gr. 3	Gr. 4	Gr. 5		
	<b>22</b>	<b>29</b>	<b>51</b>	<b>64</b>		

<b>SCL1660</b>						
Upholstered seat and back - Fabric group 1*						<b>854</b>
Surcharge Fabric group* (Fabric overview p. 92)	Gr. 2	Gr. 3	Gr. 4	Gr. 5		
	<b>36</b>	<b>63</b>	<b>125</b>	<b>208</b>		

\* Minimum order: 4 chairs

<b>Surcharge</b>		
Stethoscope in Brass / zinc, set		<b>15</b>
Felt glides, set		<b>14</b>

<b>Frame colour</b>	
Grp. 1	Black

### PRODUCT HIGHLIGHTS

- Stethoscope 4 colours - Possibility for unique design
- Integrated felt pads - sound absorbing & protects upholstery
- Scope Stool can stack 5 pcs. on floor
- Please be aware that hard and incorrect use and handling of the chair in connection with stacking can cause wear marks and scratches
- FSC Certified oak
- Metal 50% recycled
- Approved L2 test (extreme use)
- Weight: 6,9 kg.



## SCOPE RETAIL - CHAIR

Design: Hans-Thyge & Co.



Frame

Frame colour  
Black

### SC1000R-550101

Seat / back in oak - white pigmented matt lacquer\*

Notice: without Integrated felt pads



314

### SC1010R-55010109003

Upholstered seat - Black leather\*

Back in Oak - white pigmented matt lacquer

Notice: without Integrated felt pads



386

\* Colli 2

### Surcharge

Felt glides, set

14

### Stethoscope



Black

### PRODUCT HIGHLIGHTS

- FSC certified oak
- Metal 50 % recycled
- Weight 4,5 kg.



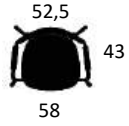

# SCOPE RETAIL - ARMCHAIR

Design: Hans-Thyge & Co.



Frame	Frame colour Black
-------	-----------------------

<b>SC1050R-550101</b> Seat / back in oak - white pigmented matt lacquer* Notice: without Integrated felt pads		<b>410</b>
---	---	------------

<b>SC1060R-55010109003</b> Upholstered seat - Black leather* Back in Oak - white pigmented matt lacquer Notice: without Integrated felt pads		<b>483</b>
---	---	------------

\* Colli 2

<b>Surcharge</b> Felt glides, set	<b>14</b>
--------------------------------------	-----------

<b>Stethoscope</b>	 Black
--------------------	--

### PRODUCT HIGHLIGHTS

- FSC certified oak
- Metal 50 % recycled
- Weight 5,3 kg.

# TAC - CHAIRS

Design: byKATO

## SEAT - MATT (PLASTIC/PA6)



White  
RAL 9010



Black  
RAL 9005



Iceblue  
NCS 3010BG

## SEAT - SHINY FIBRE REINFORCED COMPOUNDS



White (Snow)  
RAL 9010



Black  
RAL 9005



Grey (Stone)  
RAL 7030



Anthracite grey (Coal)  
RAL 7016



Yellow (Lemon)  
RAL 1012



Red (Coral)  
RAL 3016



Turquoise (Sea)  
RAL 5018

## SEAT - MATT FIBRE REINFORCED COMPOUNDS



White  
RAL 9010



Black  
RAL 9005

## LEGS



Oak  
Whitepig. matt lacquer



Oak  
Clear matt lacquer



Oak  
Black Lacquer



Walnut  
Natural oil





## TAC - CHAIR

Design: byKATO



Frame	Oak Lacquered	Oak Black lacquered	Walnut Natural oil
<b>2-3080</b>			
Matt seat (plastic/PA6)*			
	<b>264</b>	<b>264</b>	<b>302</b>
<b>2-3090</b>			
Shiny (fibre reinforced compounds) seat*			
	<b>422</b>	<b>422</b>	<b>446</b>
<b>CHOOSE YOUR OWN RAL-COLOUR - MINIMUM ORDER QUANTITY IS 10 CHAIRS IN THE SAME COLOUR</b>			
<b>2-3095</b>			
Matt (fibre reinforced compounds) seat*			
	<b>422</b>	<b>422</b>	<b>446</b>

\* Colli 4

### Seat pad in black leather

2-3097L111 Seat pad - 44,5x39 cm

**54**

### Felt and pvc floor protectors

2-3089 1 set of felt and pvc floor protectors

**12**

### Frame colour

Oak/Lacquer

Whitepigm. matt lacquer

Clear matt lacquer

Black lacquer

Walnut

Natural oil

### PRODUCT HIGHLIGHTS

- W 5 kg (Model 2-3080) 6 kg (Model 2-3090/2-3095) / CBM 0,18 (Not stackable)

- Legs not mounted on delivery

- The TAC chair fulfils the requirements in EN 1022:2005 and EN 16139:2013. Furniture - Strength, durability and safety.

# TONO - CHAIRS

Design: Hans-Thyge & Co.

## SHELL COLOURS



Felt  
Light Grey



Felt  
Dark Grey

## FRAME COLOURS (TONO 4-LEGS & TONO CONFERENCE)



Black  
RAL 9005

## FRAME COLOURS (TONO WOOD)



Ash  
Whitepig. matt lacquer



Ash  
Black matt lacquer





## TONO 4-LEGS - CHAIR

Design: Hans-Thyge & Co.

Frame

Frame colour

Gr. 1

### T1250

Seat cushion upholstered - Fabric group 1\* / shell of felt

Felt gr. 1



641

Surcharge Fabric group\*  
(Fabric overview p. 92)

Gr. 2  
19

Gr. 3  
24

Gr. 4  
42

Gr. 5  
54

### T1350

Seat cushion and inner back upholstered\*

Fabric: Re-wool

863

Fabric: Hallingdal

898

Inner back can only be upholstered with Re-wool or Hallingdal.  
The fabric on the inner back and the seat cushion must be the same.

\* Minimum order: 4 chairs

### Surcharge

Felt glides, set

14

### Frame colour

Grp. 1



Black

### PRODUCT HIGHLIGHTS

- Passed L2 (extreme use)
- The felt shell is 100% reusable
- Elegant seat cushion - non-removable
- Sound absorbing felt shell
- Ergonomic back support
- Weight: Tono 4-Legs 5,6 kg.

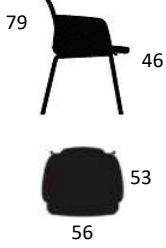



## TONO WOOD - CHAIR

Design: Hans-Thyge & Co.

Frame

Frame colour  
Gr. 1

### TW1250

Seat cushion upholstered - Fabric group 1\* / Shell of felt

Felt gr. 1



837

Surcharge Fabric group\*  
(Fabric overview p. 92)

Gr. 2  
19

Gr. 3  
24

Gr. 4  
42

Gr. 5  
54

### TW1350

Seat cushion and inner back upholstered\*

Fabric: Re-wool

1.034

Fabric: Hallingdal

1.071

Inner back can only be upholstered with Re-wool or Hallingdal.  
The fabric on the inner back and the seat cushion must be the same.

\* Minimum order: 4 chairs

### Surcharge

Felt glides, set

8

### Frame colour

Grp. 1



Ash  
Whitepig. matt lacquer



Ash  
Black lacq.

### PRODUCT HIGHLIGHTS

- Passed L2 (extreme use)
- The felt shell is 100% reusable
- Elegant seat cushion - non-removable
- Sound absorbing felt shell
- Ergonomic back support
- Weight: Tono Wood 5 kg.

79



46



53

56



## TONO CONFERENCE - CHAIR

Design: Hans-Thyge & Co.

Frame

Frame colour

Gr. 1

### T1400

Seat cushion upholstered - Fabric group 1\* / shell of felt

Felt gr. 1



875

Surcharge Fabric group\*  
(Fabric overview p. 92)

Gr. 2  
19

Gr. 3  
24

Gr. 4  
42

Gr. 5  
54

### T1450

Seat cushion and inner back upholstered\*

Fabric: Re-wool

1.071

Fabric: Hallingdal

1.108

Inner back can only be upholstered with Re-wool or Hallingdal.  
The fabric on the inner back and the seat cushion must be the same.

\* Minimum order: 4 chairs

### Frame colour

Grp. 1



Black

### PRODUCT HIGHLIGHTS

- The felt shell is 100% reusable
- Swivel chair - with 360 degree swivel base
- Elegant seat cushion - non-removable
- Sound absorbing felt shell
- Ergonomic back support
- Weight: Tono Conference 8,4 kg

79



46

Ø67



53

56



49





78



53

# UNITE - CHAIR

Design: Says Who

Frame		Oak
		Whitepigm. matt lacquer
<b>2-90010</b>	<b>B49,3xD53xH78xSH45cm</b>	
Seat in veneer - Oak / Whitepigm. matt lacquer		<b>241</b>
<b>2-90015</b>	<b>B49,3xD53xH78xSH45cm</b>	
Upholstered seat - PU leather: Black		<b>266</b>
<b>Frame colour</b>		
Oak/Lacquer		
	Whitepigm. matt lacquer	

## PRODUCT HIGHLIGHTS

- Model 2-90010 / 2-90015: W 6 kg / CBM 0,90
- Felt floor proctector mounted
- Delivered "Knock down"

## CHAIR TROLLEYS

Price



### D19900

Dry trolley, 20 chair capacity

958

Dimension LxWxH without chairs: 81x47x93 cm

Dimension LxWxH with 20 chairs (without upholstery): 118x52x140 cm



### MO19900

Mood trolley, 20 chair capacity

839

Dimension LxWxH without chairs: 79x44x120 cm

Dimension LxWxH with 20 chairs (without upholstery): 117x51x190 cm



### M1036

Hand truck trolley (universal)

358

## CHAIR SUSPENSION

CHAIR	ITEM NO. Chair suspension	PRICE 1 set suspension	TABLE					
			GRIP	TUBE FOLD	TUBE BASIC	TUBE STAY	HT1	SPACE HIGH
PURE	STPURE	34	√	√	√	√		
DRY	STDY	36	√	÷	÷	√		
MOOD	STMOOD	34	√	√	√	√		
MUST	STMUST	34	÷	√	√	√		
SCOPE	STSCOPE	41	√	÷	÷	√		
HC1	0-888	31	√	÷	÷	√	√	√
HC2	0-888	31	√	÷	÷	√	√	√



# SOFAS/LOUNGE



## **FABRIC/LEATHER GROUPS - SOFAS**

### **FABRIC GROUP A**

Cyber - Gabriel  
Grain - Gabriel  
Renewed Loop - Gabriel

### **FABRIC GROUP B**

Remix - Kvadrat  
Step Melange - Gabriel

### **FABRIC GROUP C**

Canvas - Kvadrat  
Capture - Gabriel  
Focus Royal - Gabriel  
Hero - Kvadrat  
Illusion 3.0 - Nevotex  
Illusion 3.0 Full grain - Nevotex  
Mood - Gabriel  
Passion - Gabriel  
Re-Wool - Kvadrat

### **FABRIC GROUP D**

Divina - Kvadrat  
Divina Melange - Kvadrat  
Fiord - Kvadrat  
Hallingdal 65 - Kvadrat  
Steelcut Quatro - Kvadrat  
Steelcut Trio - Kvadrat

### **FABRIC GROUP E**

Elle - Sacho/Kvadrat  
Floyd - Kvadrat  
Vidar - Kvadrat

### **LEATHER GROUP L**

Sevilla S4001 (Black)  
Sevilla S4003 (Cognac)



# A1 - SOFA AND POUF

Design: byKATO

Upholstery	C.O.M. *	Fabric gr.	Fabric gr.	Fabric gr.	Fabric gr.	Fabric gr.	Leather
		A	B	C	D	E	L

**Legs/Frame in Oak - Choose between: Whitepigmented matt lacquer / Black matt lacquer**

### 3-601- W90xD55xSH45 cm

A1 Pouf

Frame: Oak Lacquered	688	688	751	878	941	1.003	1.166
----------------------	-----	-----	-----	-----	-----	-------	-------

### 3-602- W200xD90xSH45 cm

A1 Sofa - 2½ persons

Frame: Oak Lacquered	2.141	2.141	2.268	2.646	2.898	3.278	3.669
----------------------	-------	-------	-------	-------	-------	-------	-------

### 3-603- W230xD90xSH45 cm

A1 Sofa - 3 persons

Frame: Oak Lacquered	2.520	2.520	2.646	3.151	3.403	3.783	4.278
----------------------	-------	-------	-------	-------	-------	-------	-------

\* Customers Own Material

The price of fire-resistant foam is available on request. The price depends on, among other things, the type of foam.

### Frame colour

Oak / Lacquered



Whitepigm. matt lacquer



Black matt lacquered

### PRODUCT HIGHLIGHTS

- Model 3-601: W 13 kg / CBM 0,17
- Model 3-602: W 70 kg / CBM 1,35
- Model 3-603: W 82 kg / CBM 1,55

### Fabric/Leather consumption:

- Model 3-601: Fabric: 2 m / Leather: 3,5 m2
- Model 3-602: Fabric: 7 m / Leather: 14,2 m2
- Model 3-603: Fabric: 8,5 m / Leather: 17 m2

Model 3-601

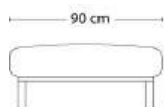
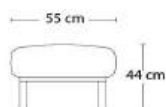

Model 3-602 / 3-603



Model 3-602

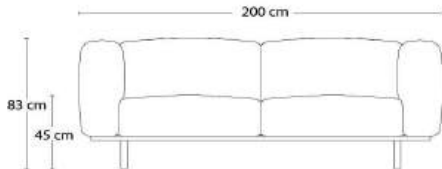

Model 3-603

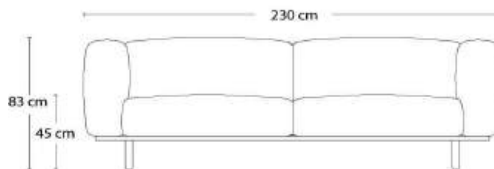



## A2 - SOFA

Design: Louise Siig Nielsen

### Upholstery

	C.O.M.*	Fabric gr.	Fabric gr.	Fabric gr.	Fabric gr.	Fabric gr.
		A	B	C	D	E
<b>3-6501- W55xD90xH78 / SH46 cm</b> Straight modular	<b>744</b>	<b>744</b>	<b>795</b>	<b>922</b>	<b>1.010</b>	<b>1.136</b>
<b>3-6502- W55xD90xH46 / SH46 cm</b> Pouf	<b>492</b>	<b>492</b>	<b>531</b>	<b>593</b>	<b>644</b>	<b>707</b>
<b>3-6505- W90xD90xH78 / SH46 cm</b> Corner modular - round	<b>1.098</b>	<b>1.098</b>	<b>1.175</b>	<b>1.376</b>	<b>1.502</b>	<b>1.641</b>
<b>3-6506- W90xD90xH78 / SH46 cm</b> Corner modular - 90 degr.	<b>1.237</b>	<b>1.237</b>	<b>1.325</b>	<b>1.578</b>	<b>1.705</b>	<b>1.893</b>
<b>3-6509- W110xD90xH78 / SH46 cm</b> Straight modular	<b>1.124</b>	<b>1.124</b>	<b>1.200</b>	<b>1.376</b>	<b>1.515</b>	<b>1.680</b>
<b>3-6514- W110xD90xH46 / SH46 cm</b> Pouf	<b>897</b>	<b>897</b>	<b>947</b>	<b>1.059</b>	<b>1.136</b>	<b>1.263</b>

\* Customers Own Material

The price of fire-resistant foam is available on request. The price depends on, among other things, the type of foam.

### PRODUCT HIGHLIGHTS

- Model 3-6501: W 20 kg / CBM 0,47
- Model 3-6502: W 15,5 kg / CBM 0,27
- Model 3-6505: W 27 kg / CBM 0,74
- Model 3-6506: W 36 kg / CBM 0,74
- Model 3-6509: W 40 kg / CBM 0,91
- Model 3-6514: W 22 kg / CBM 0,55

### Fabric consumption (For fabric width 140 cm):

- Model 3-6501: 2,5 m
- Model 3-6502: 1,5 m
- Model 3-6505: 3,6 m
- Model 3-6506: 4,5 m
- Model 3-6509: 3,7 m
- Model 3-6514: 2,2 m

Model 3-6501

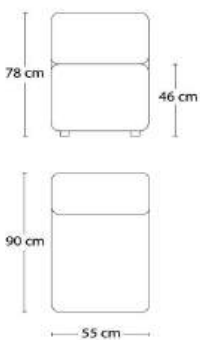

Model 3-6502

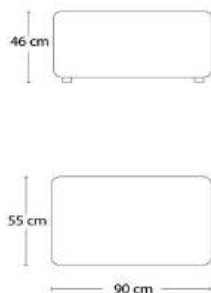

Model 3-6505

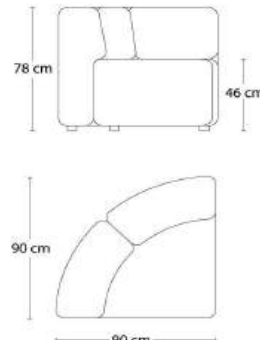

Model 3-6506

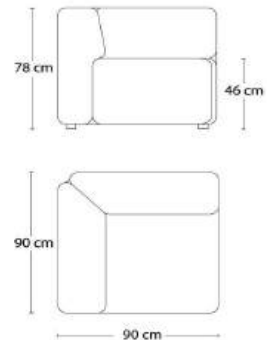

Model 3-6509

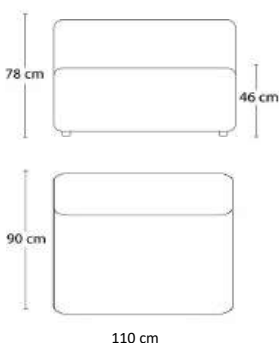

Model 3-6514

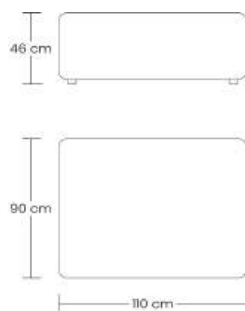



## A2 - SOFA - DINER

Design: Louise Siig Nielsen X Andersen Design Team

Upholstery	C.O.M.*	Fabric gr.	Fabric gr.	Fabric gr.	Fabric gr.	Fabric gr.
		A	B	C	D	E
<b>Legs: Oak / Whitepigm. matt lacquer</b>						
<b>3-6515- W55xD68xH78 / SH46 cm</b> Straight modular	<b>656</b>	<b>656</b>	<b>695</b>	<b>785</b>	<b>849</b>	<b>927</b>
<b>3-6516- W90xD68xH78 / SH46 cm</b> Straight modular	<b>812</b>	<b>812</b>	<b>876</b>	<b>1.003</b>	<b>1.095</b>	<b>1.210</b>
<b>3-6517- W110xD68xH78 / SH46 cm</b> Straight modular	<b>939</b>	<b>939</b>	<b>1.003</b>	<b>1.159</b>	<b>1.263</b>	<b>1.390</b>
<b>3-6518- W68xD68xH78 / SH46 cm</b> Corner modular - 90 degr.	<b>863</b>	<b>863</b>	<b>927</b>	<b>1.069</b>	<b>1.146</b>	<b>1.275</b>

\* Customers Own Material

The price of fire-resistant foam is available on request. The price depends on, among other things, the type of foam.

### PRODUCT HIGHLIGHTS

- Model 3-6515-: W 13 kg / CBM 0,24
- Model 3-6516-: W 20 kg / CBM 0,41
- Model 3-6518-: W 21 kg / CBM 0,35
- Model 3-6517-: W 25 kg / CBM 0,49

### Fabric consumption (For fabric width 140 cm):

- Model 3-6515-: 1,8 m
- Model 3-6516-: 2,5 m
- Model 3-6517-: 2,9 m
- Model 3-6518-: 2,6 m

Model 3-6515-

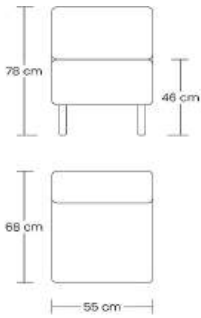

Model 3-6516-

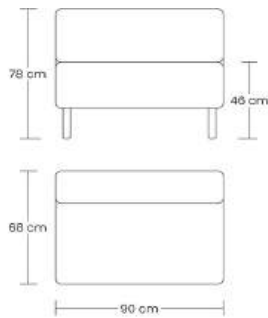

Model 3-6517-

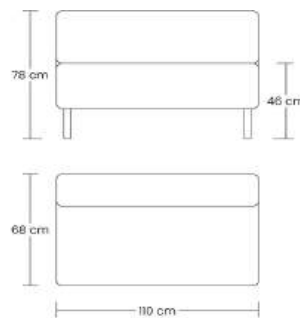

Model 3-6518-

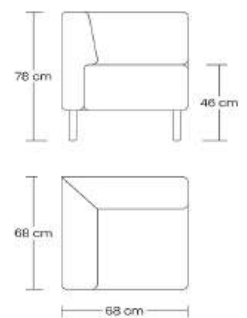



## A3 - SOFA

Design: Charlotte Høncke

Upholstery	C.O.M.*	Fabric gr.		Fabric gr.		Fabric gr.	
		A	B	C	D	E	
<b>Legs: Oak / Whitepigm. matt lacquer</b>							
<b>3-6701- 96x78xH132/SH45 cm</b> Sofa - High back module - Right	<b>1.739</b>	<b>1.739</b>	<b>1.868</b>	<b>2.190</b>	<b>2.383</b>	<b>2.641</b>	
<b>3-6702- 96x78xH132/SH45 cm</b> Sofa - High back module - Left	<b>1.739</b>	<b>1.739</b>	<b>1.868</b>	<b>2.190</b>	<b>2.383</b>	<b>2.641</b>	
<b>3-6703- 102x78xH132/SH45 cm</b> Chair - High back module	<b>1.868</b>	<b>1.868</b>	<b>2.061</b>	<b>2.383</b>	<b>2.641</b>	<b>2.963</b>	
<b>3-6704- 96x78xH82/SH45 cm</b> Sofa - Low back module - Right	<b>1.275</b>	<b>1.275</b>	<b>1.353</b>	<b>1.546</b>	<b>1.675</b>	<b>1.868</b>	
<b>3-6705- 96x78xH82/SH45 cm</b> Sofa - Low back module - Left	<b>1.275</b>	<b>1.275</b>	<b>1.353</b>	<b>1.546</b>	<b>1.675</b>	<b>1.868</b>	
<b>3-6706- 102x78xH82/SH45 cm</b> Chair - Low back module	<b>1.403</b>	<b>1.403</b>	<b>1.493</b>	<b>1.739</b>	<b>1.907</b>	<b>2.125</b>	
<b>3-6707- 90x72xH45 cm</b> Pouf	<b>708</b>	<b>708</b>	<b>746</b>	<b>849</b>	<b>927</b>	<b>1.031</b>	
<b>3-6710</b> Power (1 x 230 V og 2 x USB-A)	<b>315</b>						
<b>3-6720 32x52xH65 cm</b> Side table - top in oak/steel grey metal	<b>378</b>						

\* Customers Own Material

The price of fire-resistant foam is available on request. The price depends on, among other things, the type of foam.

### Frame colour

Oak/Lacquer



Whitepigm. matt Lacquer

### PRODUCT HIGHLIGHTS

- Model 3-6701: W 39 kg / CBM 0,96
- Model 3-6702: W 39 kg / CBM 0,96
- Model 3-6703: W 44 kg / CBM 1,02
- Model 3-6704: W 30,5 kg / CBM 0,57
- Model 3-6705: W 30,5 kg / CBM 0,57
- Model 3-6706: W 33 kg / CBM 0,61
- Model 3-6707: W 20 kg / CBM 0,23
- Model 3-6720: W 6,5 kg / CBM 0,11

### Fabric consumption:

- Model 3-6701: 5,5 m
- Model 3-6702: 5,5 m
- Model 3-6703: 6,5 m
- Model 3-6704: 3,8 m
- Model 3-6705: 3,8 m
- Model 3-6706: 4,5 m
- Model 3-6707: 2,0 m

# A3 - SOFA

Design: Charlotte Højncke

Model 3-6701

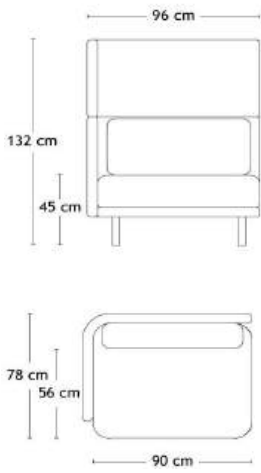

Model 3-6702

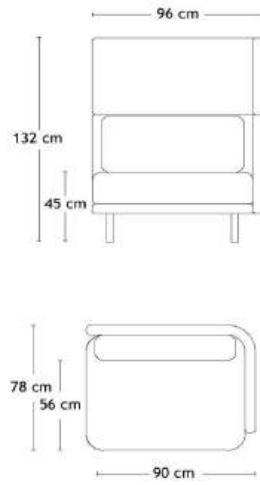

Model 3-6703

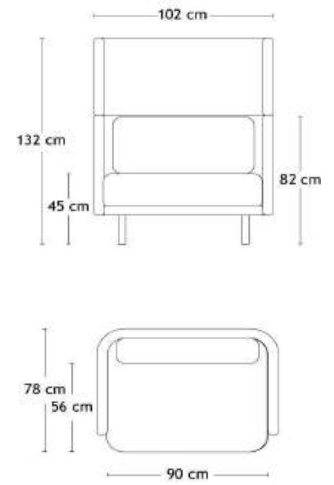

Model 3-6704

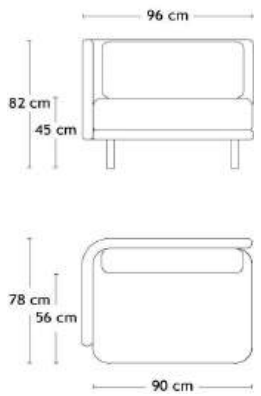

Model 3-6705

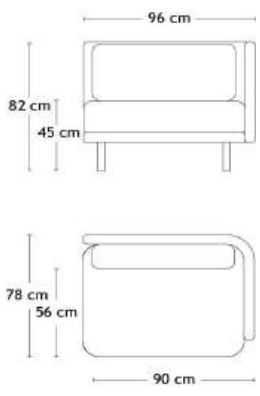

Model 3-6706

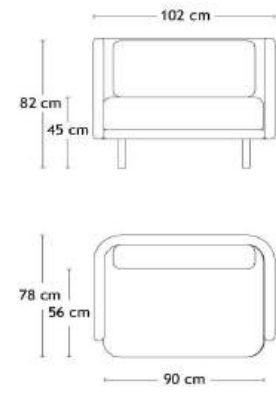

Model 3-6707

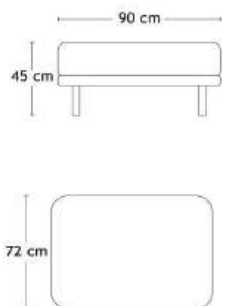

Model 3-6720

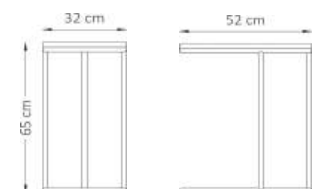



## LC1 - LOUNGECHAIR

Design: Andersen Design Team

Upholstery	Black (S4001) Sevilla Leather	Cognac (S4003) Sevilla Leather
<b>3-620 B72xD82xH77xSH42 cm</b>		
Lounge chair with leather upholstery		
Legs: Oak/Whitepigmented matt lacquer	<b>1.636</b>	<b>1.636</b>
Legs: Oak/Black matt lacquered	<b>1.636</b>	

Upholstery	C.O.M.*	Fabric gr.	Fabric gr.	Fabric gr.	Fabric gr.	Fabric gr.
		A	B	C	D	E

### Frame in Oak - Choose between: Whitepigmented matt lacquer / Black matt lacquer

<b>3-620 B72xD82xH77xSH42 cm</b>						
Lounge chair with fabric upholstery						
Oak/Lacquer	<b>1.636</b>	<b>1.636</b>	<b>1.761</b>	<b>1.888</b>	<b>2.014</b>	<b>2.141</b>

### PRODUCT HIGHLIGHTS

- Model 3-620: W 21 kg / CBM 0,6

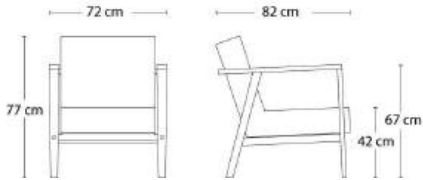

# STORAGE



# S1 - SIDEBOARD

Design: byKATO

## FRONTS IN LAMINATE - VARIANTS

### Multi Sand



Iron  
F7902



Pumice  
F7858



Iron  
F7902



Silver  
F2791

### Multi Earth



Terril  
F2297



Cafe  
F0903



Terril  
F2297



Kashmir  
F0187

### White



White (Alpino)  
K1040

### Black



Diamond Black  
F2253

## TYPES OF WOOD - LEGS



Oak  
Soap



Oak  
White oil



Oak  
Natural oil



Oak  
Black lacquer



## S1 - SIDEBOARD

Design: byKATO

Cabinet	Oak Soap	Oak Oil*	Oak Black matt lacquer
<b>5-110A L200xD50xH68 cm (incl. plinth)</b> Incl. 4 doors + 4 shelves **	<b>3.437</b>	<b>3.558</b>	<b>3.136</b>
* Choose between: White oil / Natural oil			
** Choose between 4 different door combinations for the front. (Each door has the same colour on the front and back).			
Tray		Oak Soap	Oak Oil*
<b>Tray in solid wood w/tenon jointed edges</b> 5-135T B47xD41,5xH7 cm		<b>181</b>	<b>181</b>
Extra shelf			Black
<b>Shelf</b> 5-140			<b>73</b>

### PRODUCT HIGHLIGHTS

- Model 5-110A: W 80 kg / CBM 0,6

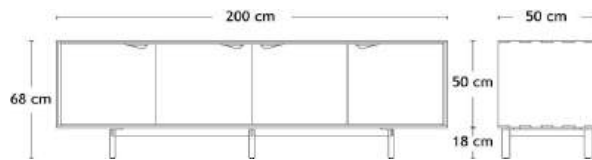

## S2 - SHELVES

Design: byKATO

### DOORS - LAMINATE



White (Alpino)  
K1040



Kashmir  
F0187



Pumice  
F7858

### DOORS - LOUDSPEAKER FABRIC (Only S2 TV-Module)



Black

### TYPES OF WOOD - CABINET



Oak  
Soap



Oak  
White Oil



Oak  
Natural oil



Oak  
Black Lacquer

## S2 - SHELF SYSTEM (HEIGHT 51 CM)

Design: byKATO

Cabinet	Oak Soap	Oak Oil*	Oak Black matt lacquer
---------	----------	----------	------------------------



### 5-402 L118xD36 cm

2-room element H51 cm

Incl. 2 doors (in the same colour)\*\*, 2 shelves, and a mounting list

1.576

1.636

1.576



### 5-404 L118xD36 cm

2-room element H51 cm

Incl. 1 door\*\*, 1+3 shelves, 3 solid wood trays, and a mounting list

1.810

1.869

1.810

\* Oak/Oil - Choose between: White oil - Natural oil

Choose between the colours: White – Kashmir – Pumice

Choose between the following fronts:

Alpino



Kashmir



Pumice



Model 5-402

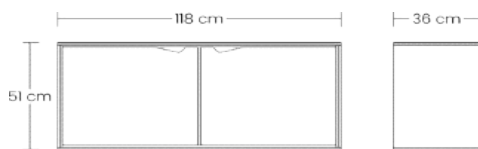

Model 5-404

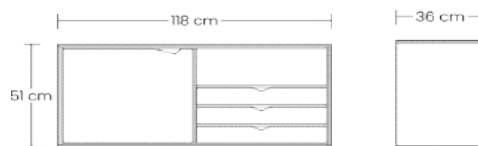

## S2 - SHELF SYSTEM (TV-MODULE - H32 CM)

Design: byKATO

Cabinet	Oak Soap	Oak Oil*	Oak Black matt lacquer
---------	-------------	-------------	---------------------------

### 5-406 L118xD36 cm

2-room element - TV Module - H32 cm

1.429

1.488

1.429

Incl. 2 doors with black loudspeaker fabric and a mounting list

\* Oak/Oil - Choose between: White oil - Natural oil

### PRODUCT HIGHLIGHTS

- Model 5-406: W 22 kg / CBM 0,16

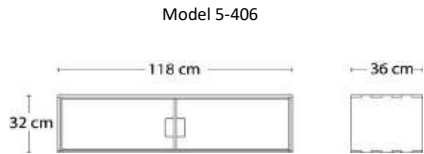

## S3 - S5 - S6 - S7 - S8 SERIES

Design: byKATO

### FRONTS - LAMINATE

Choose between the following fronts:

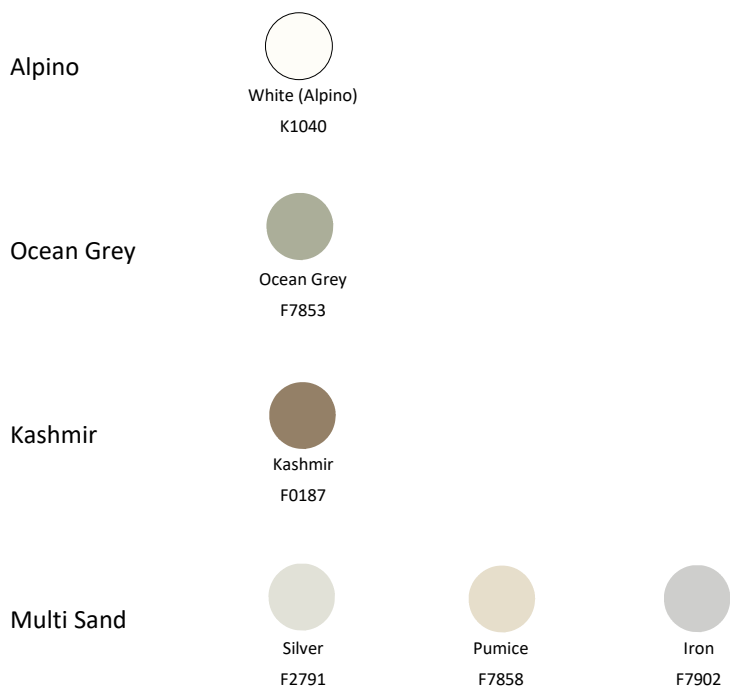

### TYPES OF WOOD - LEGS

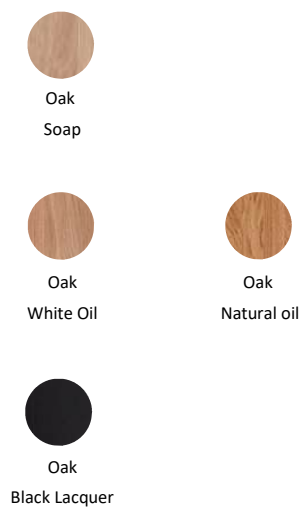



## S3 - S5 STORAGE

Design: byKATO

Cabinet	Oak Soap	Oak Oil*	Oak Black matt lacquer
<b>5-505</b> B130xD43xH132 cm S3 storage incl. 3 shelves	<b>3.619</b>	<b>3.739</b>	<b>3.497</b>
<b>5-515</b> B83xD43xH132 cm S5 storage incl. 1 shelf	<b>3.136</b>	<b>3.256</b>	<b>3.014</b>

\* Oak/Oil - Choose between: White oil - Natural oil

Shelf		Black
5-510H307	B31xD38 cm	<b>41</b>
5-510H467	B47xD38 cm	<b>46</b>
Brushed steel rings to mount on legs		Surcharge
5-511	4 pcs. Brushed steel rings	<b>19</b>

Choose between the following front:

Alpino



Ocean Grey



Kashmir



Multi Sand



### PRODUCT HIGHLIGHTS

- Model 5-505: W 85 kg / CBM 1,61

- Model 5-515: W 75 kg / CBM 0,68

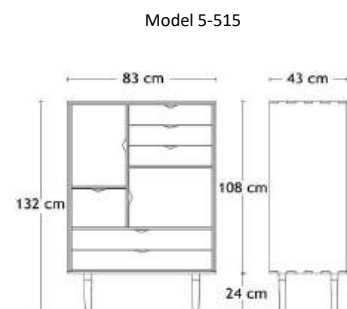
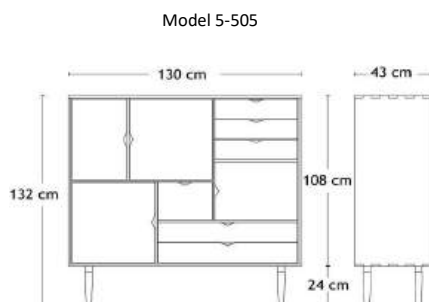

Placement of shelves:

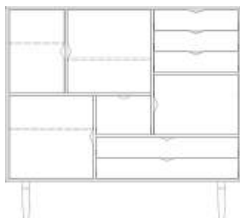



## S6 - S7 SIDEBOARD

Design: byKATO

Cabinet	Oak Soap	Oak Oil*	Oak Black matt lacquer
<b>5-525 B163xD43xH80 cm</b> S6 sideboard incl. 2 shelves	<b>2.773</b>	<b>2.893</b>	<b>2.651</b>



<b>5-530 B163xD43xH80 cm</b> S7 sideboard incl. 4 shelves	<b>2.290</b>	<b>2.410</b>	<b>2.168</b>
--	--------------	--------------	--------------

\* Oak/Oil - Choose between: White oil - Natural oil

Shelf	Black
-------	-------

Shelf		
5-510H307	B31xD38 cm	<b>41</b>
5-510H467	B47xD38 cm	<b>46</b>

Brushed steel rings to mount on legs	Surcharge
--------------------------------------	-----------

5-511 4 pcs. Brushed steel rings	<b>19</b>
----------------------------------	-----------

Choose between the following front:

Alpino 

Ocean Grey 

Kashmir 

Multi Sand 

### PRODUCT HIGHLIGHTS

Model 5-525: W 77 kg / CBM 0,46

Model 5-530: W 60 kg / CBM 0,46

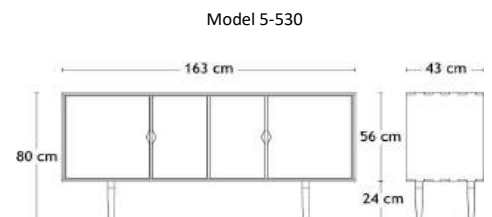
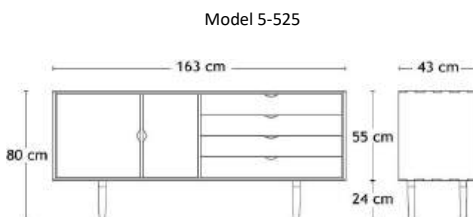



## S8 - STORAGE

Design: byKATO

Cabinet	Oak Soap	Oak Oil	Oak Black matt lacquer
<b>5-520</b>	<b>B83xD43xH107 cm</b>		
S8 storage	<b>2.651</b>	<b>2.773</b>	<b>2.531</b>

\* Oak/Oil - Choose between: White oil - Natural oil

Brushed steel rings to mount on legs	Surcharge
5-511 4 pcs. Brushed steel rings	<b>19</b>

Choose between the following front:

Alpino 

Ocean Grey 

Kashmir 

Multi Sand 

### PRODUCT HIGHLIGHTS

- Model 5-520: W 60 kg / CBM 0,42

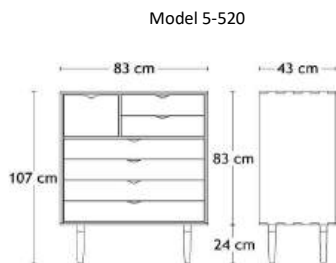



## S10 - SIGNATURE CABINETS

Design: Andersen Design Team

		Oak veneer Whitepig. matt lack
<b>7-140020</b>	B38xD30xH38 cm Cabinet with door	<b>264</b>
<b>7-140021</b>	B38xD30xH38 cm Cabinet without door	<b>217</b>
Shelf		Oak veneer
<b>7-140022</b>	B35,5xD26xH1,3 cm	<b>47</b>

### Material

Oak/Veneer



Whitepig.  
matt lacquer

### PRODUCT HIGHLIGHTS

- Model 7-140020: W 6,2 kg / CBM 0,043
- Model 7-140021: W 5 kg / CBM 0,043
- Model 7-140022: W 1 kg / CBM 0,001

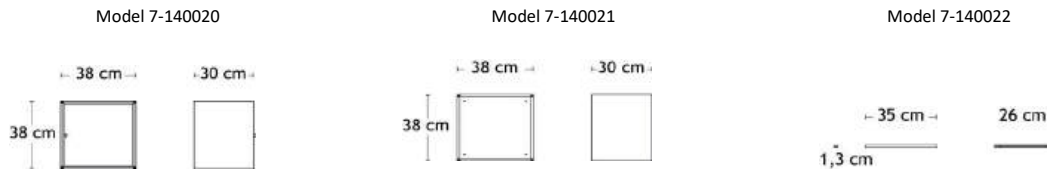



## UNIQUES - SIDEBOARD

Design: byKATO

Cabinet - Sideboard

Oak veneer  
Black lacq.

Oak veneer  
Whitepig. lacq.

**7-111001** B163xD43xH80 cm  
Oak veneer doors  
**Sideboard incl. 4 shelves**

**1.807**

**7-111020** B163xD43xH80 cm  
Oak veneer doors  
**Sideboard incl. 4 shelves**

**1.807**

### Cabinet

Oak/Veneer

  
Whitepig.  
matt lacquer

  
Black matt lacquer

### Front

Oak/Veneer

  
Whitepig.  
matt lacquer

### PRODUCT HIGHLIGHTS

- Model 7-111001 / 7-111020: W 46 kg / CBM 0,43

Model 7-111001 / 7-111020

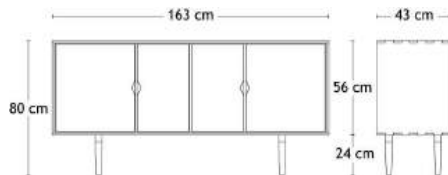

# RUGS



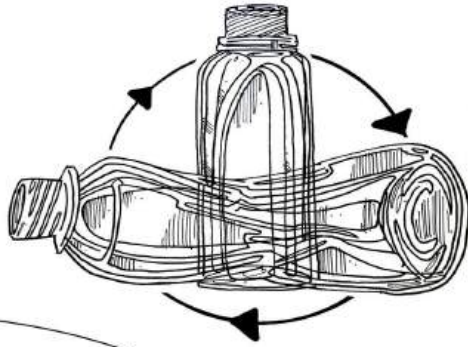

The felt material on the back of the rug is made from recycled plastic bottles

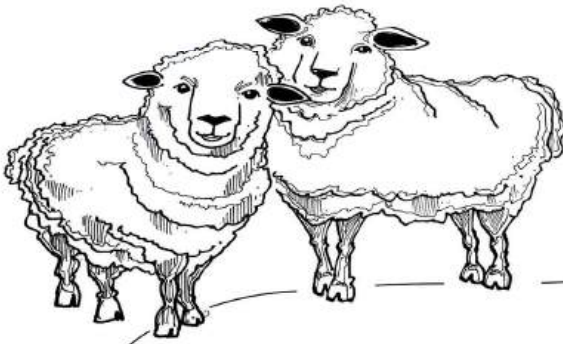

Flow consists of 80% high-quality wool from New Zealand sheep - the remaining 20% is polyamide

Cradle to Cradle certified – based on that the product must not have a negative impact on the planet

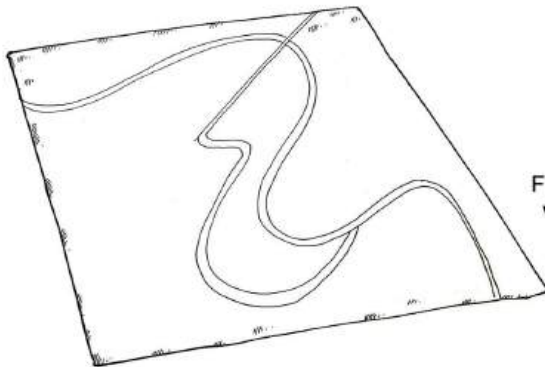
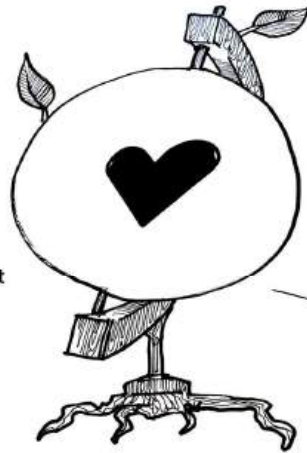

Flow Rug  
Warmth and contrast for the home  
- with a clear conscience



## FLOW - RUG

Design: Raket Villesen

Rugs

80% Wool  
20% Polyamide



**7-510001**

**Rug 140x200 cm**

**603**



**7-510002**

**Rug 165x235 cm**

**725**



**7-510003**

**Rug 200x300 cm**

**1.086**



# DESIGN INTERIOR



## DESIGN INTERIOR - DESIGNERS

### Allan Nøddebo

Seat Bench & Stool

### Anne Qvist

U3 Cuttingboard

### Amalie Bergholdt

A-Wall Clock

My Tree

### ByKato

Tray Table

### Charlotte Høncke Design

A-Organizer Shelf

A-Podium Shelf

### Christian Juhl

U1 Stool

### Dögg

Edge Mirror / Magazine Holder / Side Table

### Henrik

Wood Time

### Jacob Jensen

The Vikings

### Karsten Dybvad Vinge

Connect Table

### Kira Usbeck

Andersen Textiles

Andersen Totebag

B1 Bench

Column Shoe Rack

Gourmet Wood Box

Knife Block

Treat Shelf

### Lasse Sortkjær

Clothes Rack

### Louise Siig

A-Flash Portable Lamp

A-Light Shelf

Birdie

Celebrating

Contrast Hooks

Key Cabinet

Multi Mirror

My Dog

Oak Nordic Tealight/Candleholder

Owl

Squirrel

Twill Weave Cushion

### Maria Araghouna

Salt/Pepper Mill

### Martina Claesson

Plinth stool

### Nordic Wood Interiør

Cyna Lamp

### Philip Bro

Boogie Salt/Pepper Mill

Spinn Candle LED

### Rakel Villesen

ARC Carvingboard

Circle Cuttingboard

Curve Carvingboard

Donut Stool

Flection Serving Tray

Interior Rack

Pipe Lantern

Reach Stool

Square Lantern

### Says Who

B3 Bench

Collect Mirror

Collect Pinboard

Bend Shelf

Essence Shelf

Evoke Coffee table

Level Shelf

Mono Coat Rack

Multi Hooks

Phase Shelf

Pillar Shelf

Unite chair

View TV Stand

### SPARK by Thomas Pedersen

Shelf 1, 2 & 3

### Andersen Design Team

Andersen Carvingboard

Andersen Tray Holder

A-Shelf

Create Me

Division Shelf

Glance Mirror

Keep Shelf

Knife Rack

Magnetic Wood Trivet

Paper Towel holder

S10 Signature modules

Sector Shelf

Serving Tray

Servingboard

Shelf 10 & 11

Shelf Wood Wall

Spectra Hooks

Tailor Shelf

Tapasboard

Toilet Towel holder















Towel Grip

## NOTE















### **Breach of sales colli:**

It is not possible to break the sales unit.















## LIVING

Item no.		Colli	Price per unit
	4-101001 Create Me Box - 6x12 cm 1 Comp. - Black	4	24
	4-101020 Create Me Box - 6x12 cm 1 Comp. - Oak	4	28
	4-102001 Create Me Box - 6x12 cm 2 Comp. - Black	4	24
	4-102020 Create Me Box - 6x12 cm 2 Comp. - Oak	4	28
	4-103001 Create Me Box - 12x12 cm 1 Comp. - Black	4	36
	4-103020 Create Me Box - 12x12 cm 1 Comp. - Oak	4	40
	4-104001 Create Me Box - 12x12 cm 2 Comp. - Black	4	36
	4-104020 Create Me Box - 12x12 cm 2 Comp. - Oak	4	40
	4-105001 Create Me Box - 12x12 cm 4 Comp. - Black	4	36
	4-105020 Create Me Box - 12x12 cm 4 Comp. - Oak	4	40
	4-109001 Create Me Lid - 6x12 cm Black	4	16
	4-109002 Create Me Lid - 6x12 cm White	4	16
	4-110001 Create Me Lid - 12x12 cm Black	4	22
	4-110002 Create Me Lid - 12x12 cm White	4	22















## LIVING

Item no.		Colli	Price per unit
	4-113001 Create Me Tray - 12x24 cm Black	2	<b>34</b>
	4-113020 Create Me Tray - 12x24 cm Oak	2	<b>34</b>
	4-114001 Create Me Tray - 24x24 cm Black	2	<b>48</b>
	4-114020 Create Me Tray - 24x24 cm Oak	2	<b>48</b>
	4-115001 Create Me Tray - 36x24 cm Black	2	<b>60</b>
	4-115020 Create Me Tray - 36x24 cm Oak	2	<b>60</b>
	4-119001 Create Me Tea Light - 3,5 cm Black	8	<b>16</b>
	4-120020 Create Me Tea Light - 5,0 cm Oak	8	<b>18</b>
	4-120001 Create Me Tea Light - 5,0 cm Black	8	<b>18</b>
	4-118020 Create Me Candleholder - 7,5 cm Oak	4	<b>20</b>
	4-118001 Create Me Candleholder - 7,5 cm Black	4	<b>20</b>
	4-346001 Spinn Candle LED - H20 cm Black	2	<b>156</b>
	4-346020 Spinn Candle LED - H20 cm Oak	2	<b>156</b>
	4-366020 Square Lantern - Small 20x12xH28 cm Glass/Oak	2	<b>84</b>
	4-365020 Square Lantern - Tall 12x12xH40 cm Glass/Oak	4	<b>96</b>















## LIVING

Item no.		Colli	Price per unit	
	4-341020	Oak Nordic Tea Light - H4xØ11 cm Oak	2	48
	4-342020	Oak Nordic Candle Holder - Medium H6xØ10 cm Oak	2	54
	4-343020	Oak Nordic Candle Holder - Large H11xØ8 cm Oak	2	60
	4-360001	Pipe Lantern - Ø14xH20 cm/Ø20xH30 cm - Set Of 2 Glass/Metal	4	60
	4-175020	Andersen Birdie - Small H7,5xØ5,7 cm Oak	2	40
	4-176020	Andersen Birdie - Medium H9xØ7 cm Oak	2	52
	4-177020	Andersen Birdie - Large H11xØ9 cm Oak	2	70
	4-234020	Andersen Owl - Small H7,5xØ5,7 cm Oak	2	40
	4-235020	Andersen Owl - Medium H9xØ6,8 cm Oak	2	52
	4-237020	My Dog - Small H7,5x9,4x4,5 cm Oak	2	54
	4-317020	Andersen Squirrel - Large H10,5x6,5x10 cm Oak	2	70
	4-333020	Christmas Hat For Andersen Wooden Figures H3,3x3,7 cm	6	12
	4-245020	Rød Studenterhue Til Andersen Small Owl H0,75x3,6 cm	6	12
	4-246020	Blå Studenterhue Til Andersen Small Owl H0,75x3,6 cm	6	12















## LIVING

Item no.		Colli	Price per unit	
	4-347000	My Tree - Cypress - H16xØ5cm Linden Wood	2	<b>48</b>
	4-348000	My Tree - Oak - H10,5xØ11,5 cm Linden Wood	2	<b>52</b>
	4-349000	My Tree - Chestnut - H12,5xØ11,5 cm Linden Wood	2	<b>54</b>
	4-356010	The Vikings Of Denmark - Set Of 3 Stained Beech	2	<b>120</b>
	4-352001	Celebrating - H40x3,5 cm Oak/Brass - Denmark	2	<b>48</b>
	4-387001	A-Flash Portable Lamp - H22 cm Aluminium/Glass - Black	2	<b>158</b>
	4-387005	Cyna Lamp - Ø50xH41 cm Oak Veener Matt Lacquer	1	<b>302</b>
	K-707080	NT - Key Cabinet - 19,8x9,5xH25 cm Oak	2	<b>84</b>
	4-379020	Collect Pinboard - Medium 64x6xH74 cm Oak	1	<b>338</b>
	4-380020	Collect Pinboard - Large 94x6xH104 cm Oak	1	<b>410</b>
	4-350001	A-Wall Clock - 41x3,5xH76 cm Black With Black Metal Ring	2	<b>156</b>
	4-350020	A-Wall Clock - 41x3,5xH76 cm Oak With Brass Ring	2	<b>156</b>
	4-145020	Wood Time - Ø22 cm Oak	2	<b>156</b>
	4-146001	Wood Time Holder Black	2	<b>36</b>















## LIVING

Item no.		Colli	Price per unit	
	4-370020	Multi Hooks - 10 cm/15 cm/20 cm - Set Of 3 Oak	4	72
	4-325020	Contrast Hooks - Ø3 cm - Set Of 2 Oak/Black	5	22
	4-326020	Contrast Hook - Ø5 cm Oak/Black	4	22
	4-327020	Contrast Hook - Ø7 cm Oak/Black	4	34
	4-328020	Contrast Hooks - Ø3 cm - Set Of 2 Oak/Beige	5	22
	4-329020	Contrast Hook - Ø5 cm Oak/Beige	4	22
	4-330020	Contrast Hook - Ø7 cm Oak/Beige	4	34
	4-378020	Mono Coat Rack - Large 59x4,5xH12,5 cm Oak	4	194
	4-378001	Mono Coat Rack - Large 59x4,5xH12,5 cm Ash Matt Black	4	194
	4-403020	Spectra Hooks Ø3 cm - Set Of 2 Oak	6	28
	4-403025	Spectra Hooks Ø3 cm - Set Of 2 Grey Marble	6	28
	4-404020	Glance Mirror - B52xD6xH45 cm Oak	1	180
	4-432001	Edge Magazine Holder - 38x35xH45 cm Powder Coated Metal - Black	1	176
	4-433001	Edge Mirror - 7x38xH72 cm Powder Coated Metal - Black	1	114















## SHELVES

Item no.		Colli	Price per unit
	4-222021 Shelf 10 - 32x12 cm Oak White Pigmented Matt Lacquer	2	<b>72</b>
	4-223021 Shelf 11 - 44x12 cm Oak White Pigmented Matt Lacquer	2	<b>96</b>
	4-222025 Shelf 10 - 32x12 cm Dark Stain Matt Lacquer Ash	2	<b>90</b>
	4-223025 Shelf 11 - 44x12 cm Dark Stain Matt Lacquer Ash	2	<b>114</b>
	4-222002 Shelf 10 - 32x12 cm Beech Black	2	<b>78</b>
	4-223002 Shelf 11 - 44x12 cm Beech Black	2	<b>102</b>
	4-165020 Shelf 1 - 40x18 cm Oak	2	<b>84</b>
	4-166020 Shelf 2 - 59x25 cm Oak	2	<b>120</b>
	4-167020 Shelf 3 - 78,5x22 cm Oak	2	<b>144</b>
	4-165025 Shelf 1 - 40x18 cm Oiled Nature Oak	2	<b>96</b>
	4-166025 Shelf 2 - 59x25 cm Oiled Nature Oak	2	<b>132</b>
	4-167025 Shelf 3 - 78,5x22 cm Oiled Nature Oak	2	<b>158</b>
	4-165040 Shelf 1 - 40x18 cm Smoked Oiled Ash	2	<b>84</b>
	4-166040 Shelf 2 - 59x25 cm Smoked Oiled Ash	2	<b>120</b>
	4-167040 Shelf 3 - 78,5x22 cm Smoked Oiled Ash	2	<b>144</b>















## SHELVES

Item no.		Colli	Price per unit
	4-178001 Shelf Wood Wall - Small 30x18xH24 cm Black	2	<b>108</b>
	4-178020 Shelf Wood Wall - Small 30x18xH24 cm Oak	2	<b>108</b>
	4-179001 Shelf Wood Wall - Medium 45x20xH32 cm Black	2	<b>144</b>
	4-179020 Shelf Wood Wall - Medium 45x20xH32 cm Oak	2	<b>144</b>
	4-180001 Shelf Wood Wall - Large 60x25xH32 cm Black	2	<b>170</b>
	4-180020 Shelf Wood Wall - Large 60x25xH32 cm Oak	2	<b>170</b>
	4-359020 Interior Rack - 70x10,6x27,5 cm Oak	2	<b>158</b>
	4-170020 A-Shelf - Medium 9x46xH52 cm Oak	2	<b>168</b>
	4-171020 A-Shelf - Large 12x67xH78 cm Oak	2	<b>216</b>
	4-170040 A-Shelf - Medium 9x46xH52 cm Smoked Oiled Ash	2	<b>168</b>
	4-171040 A-Shelf - Large 12x67xH78 cm Smoked Oiled Ash	2	<b>216</b>
	4-170050 A-Shelf - Medium 9x46xH52 cm Oiled Nature Oak	2	<b>180</b>
	4-171050 A-Shelf - Large 12x67xH78 cm Oiled Nature Oak	2	<b>234</b>
	4-171060 A-Shelf - Medium 9x46xH52 cm Black Steel	2	<b>144</b>
	4-171070 A-Shelf - Large 12x67xH78 cm Black Steel	2	<b>180</b>













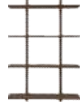

## SHELVES

Item no.		Colli	Price per unit
	4-171062 A-Shelf - Medium 9x46xH52 cm Silver Steel	2	144
	4-171072 A-Shelf - Large 12x67xH78 cm Silver Steel	2	180
	4-171064 A-Shelf - Medium 9x46xH52 cm Brass	2	144
	4-171074 A-Shelf - Large 12x67xH78 cm Brass	2	180
	4-358020 A-Light Shelf - 90x21xH35 cm Oak	2	144
	4-358030 A-Light Shelf - 90x21xH35 cm Smoked Oiled Ash	2	156
	4-358025 A-Light Shelf - 90x21xH35 cm Oiled Nature Oak	2	168
	4-385020 A-Podium Shelf - 52x10xH70 cm Oak White Laquer	1	326
	4-383020 A-Organizer Shelf 1 - 52x17xH18 cm Oak White Matt Lacquer / 4 Glass Jugs	1	326
	4-384020 A-Organizer Shelf 2 - 52x17xH18 cm Oak White Laquer / 10 Glass Jugs	1	422
	4-390020 Tailor Shelf - 52x10xH44,8 cm Oak	1	204
	4-424070 Division Shelf - 45x10xH45 cm Black Steel	4	144
	4-422020 Sector Shelf - 50x10xH50 cm Oak	4	132
	4-422025 Sector Shelf - 50x10xH50 cm Oiled Nature Oak	4	144
	4-422040 Sector Shelf - 50x10xH50 cm Smoked Oiled Oak	4	144

## SHELVES















Item no.		Colli	Price per unit
	4-420020	Treat Shelf Single - Small 34x12xH11,2 cm Oak	4 <b>48</b>
	4-420520	Treat Shelf Single - Large 50x12xH11,2 cm Oak	4 <b>64</b>
	4-420025	Treat Shelf Single - Small 34x12xH11,2 cm Oiled Nature Oak	4 <b>56</b>
	4-420525	Treat Shelf Single - Large 50x12xH11,2 cm Oiled Nature Oak	4 <b>72</b>
	4-420040	Treat Shelf Single - Small 34x12xH11,2 cm Smoked Oiled Oak	4 <b>56</b>
	4-420540	Treat Shelf Single - Large 50x12xH11,2 cm Smoked Oiled Oak	4 <b>72</b>
	4-421020	Treat Shelf Double - Small 34x12xH34 cm Oak	4 <b>96</b>
	4-421520	Treat Shelf Double - Large 50x12xH50 cm Oak	4 <b>132</b>
	4-421025	Treat Shelf Double - Small 34x12xH34 cm Oiled Nature Oak	4 <b>108</b>
	4-421525	Treat Shelf Double - Large 50x12xH50 cm Oiled Nature Oak	4 <b>144</b>
	4-421040	Treat Shelf Double - Small 34x12xH34 cm Smoked Oiled Oak	4 <b>108</b>
	4-421540	Treat Shelf Double - Large 50x12xH50 cm Smoked Oiled Oak	4 <b>144</b>
	4-425020	Phase Shelf - 60x18xH55 cm Oak	4 <b>158</b>
	4-425025	Phase Shelf - 60x18xH55 cm Oiled Nature Oak	4 <b>170</b>
	4-425040	Phase Shelf - 60x18xH55 cm Smoked Oiled Oak	4 <b>170</b>

## SHELVES















Item no.		Colli	Price per unit	
	4-426020	Essence Shelf - 70x25xH140 cm Oak	1	<b>483</b>
	4-426025	Essence Shelf - 70x25xH140 cm Oiled Nature Oak	1	<b>519</b>
	4-426040	Essence Shelf - 70x25xH140 cm Smoked Oiled Oak	1	<b>519</b>
	4-427020	Pillar Shelf - Small 60x15xH12 cm Oak	4	<b>120</b>
	4-427025	Pillar Shelf - Small 60x15xH12 cm Oiled Nature Oak	4	<b>138</b>
	4-427040	Pillar Shelf - Small 60x15xH12 cm Smoked Oiled Oak	4	<b>138</b>
	4-427520	Pillar Shelf - Large 78x15xH12 cm Oak	4	<b>152</b>
	4-427525	Pillar Shelf - Large 78x15xH12 cm Oiled Nature Oak	4	<b>170</b>
	4-427540	Pillar Shelf - Large 78x15xH12 cm Smoked Oiled Oak	4	<b>170</b>
	4-428020	Bend Shelf - 50x18xH40 cm Oak	4	<b>170</b>
	4-428025	Bend Shelf - 50x18xH40 cm Oiled Nature Oak	4	<b>182</b>
	4-428040	Bend Shelf - 50x18xH40 cm Smoked Oiled Oak	4	<b>182</b>
	4-429020	Level Shelf - 55x18xH9 cm Oak	4	<b>108</b>
	4-429025	Level Shelf - 55x18xH9 cm Oiled Nature Oak	4	<b>120</b>
	4-429040	Level Shelf - 55x18xH9 cm Smoked Oiled Oak	4	<b>120</b>

















## TEXTILES

Item no.		Colli	Price per unit	
	4-334001	Twill Weave Cushion - 45x50 cm Red - 32%Wool 60%Cotton 8%Nylon	2	48
	4-334004	Twill Weave Cushion - 35x60 cm Red - 32%Wool 60%Cotton 8%Nylon	2	48
	4-411001	Andersen Towel - 50x100 cm Beige/Green - Organic Cotton	6	24
	4-411002	Andersen Towel - 70x140 cm Beige/Green - Organic Cotton	6	42
	4-414001	Andersen Dish Cloth - 27x27 cm - Set Of 2 Oat/Beige/Blue - Organic Cotton	12	16
	4-414002	Andersen Dish Cloth - 27x27 cm - Set Of 2 Oat/Green/Brown - Organic Cotton	12	16
	4-414003	Andersen Kitchen Towel - 50x80 cm Oat/Beige/Blue - Organic Cotton	8	20
	4-414004	Andersen Kitchen Towel - 50x80 cm Oat/Green/Brown - Organic Cotton	8	20
	4-414009	Andersen Tea Towel - 50x70 cm - Set Of 2 Oat/Beige/Blue - Organic Cotton	8	24
	4-414010	Andersen Tea Towel - 50x70 cm - Set Of 2 Oat/Green/Brown - Organic Cotton	8	24
	4-414005	Andersen Napkin - 45x45 cm - Set Of 2 Oat/Beige - Organic Cotton	8	16
	4-414006	Andersen Napkin - 45x45 cm - Set Of 2 Oat/Green - Organic Cotton	8	16
	4-414007	Andersen Placemat - 50x36 cm Oat/Beige/Blue - Organic Cotton	6	12
	4-414008	Andersen Placemat - 50x36 cm Oat/Green/Brown - Organic Cotton	6	12
	4-414011	Andersen Totebag - 42x40 cm Oat/Beige - Organic Cotton	12	20









## KITCHEN

Item no.		Colli	Price per unit
	4-123020 Tapasboard - Small Ø28 cm Oak	2	48
	4-125020 Tapasboard - Medium Ø36 cm Oak	2	66
	4-127020 Tapasboard - Large Ø45 cm Oak	2	84
	4-130020 Servingboard - 35x21 cm Oak	2	36
	4-131020 Servingboard - 40x21 cm Oak	2	42
	4-133020 Servingboard - 45x25 cm Oak	2	54
	4-134020 Servingboard - 60x25 cm Oak	2	72
	4-150020 U3 Cuttingboard - Small 32x17 cm Oak	2	36
	4-151020 U3 Cuttingboard - Medium 46x24 cm Oak	2	60
	4-331020 Andersen Carvingboard - Medium 40x24 cm Oak	2	47
	4-332020 Andersen Carvingboard - Large 50x27 cm Oak	2	60
	4-364020 Circle Cuttingboard - 44,5x22 cm Oak	4	72
	4-368030 ARC Carvingboard - Medium 40x24x2,5 cm Acacie (FSC)	6	72
	4-392020 Curve Carvingboard - Medium 40x24 cm Oak - FSC 100%	4	48
	4-393020 Curve Carvingboard - Large 50x27 cm Oak - FSC 100%	4	66















## KITCHEN

Item no.		Colli	Price per unit
	4-210001 Paper Towel Holder - 33 cm Black	4	54
	4-210020 Paper Towel Holder - 33 cm Oak	4	54
	4-206020 Knife Rack - 32 cm Oak	2	66
	4-206025 Knife Rack - 32 cm Dark Stain Matt Lacquer Ash	2	66
	4-287020 Knife Block - 22x8,5xH24 cm Oak	2	144
	4-287025 Knife Block - 22x8,5xH24 cm Dark Stain Matt Lacquer Ash	2	144
	4-198001 Salt/Pepper Mill - 18 cm Black	4	60
	4-198020 Salt/Pepper Mill - 18 cm Oak	4	60
	4-336001 Boogie Salt & Pepper Mill - H12 cm Black	4	47
	4-336002 Boogie Salt & Pepper Mill - H12 cm White	4	47
	4-285020 Magnetic Wood Trivet - 24x11,5 cm Oak	4	36
	4-190020 Serving Tray - 28x28 cm Oak	2	60
	4-194020 Serving Tray - 40x28 cm Oak	2	84
	4-195020 Serving Tray - 46x30 cm Oak	2	90
	4-286020 Gourmet Wood Box - 20x35xH16,5 cm Oak	2	192

## KITCHEN











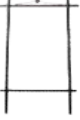



Item no.		Colli	Price per unit
	4-290001 Napkin Holder - 18x18 cm Black	4	<b>46</b>
	4-394020 Flection Serving Tray - Medium 30x20 cm Oak - FSC 100 %	2	<b>60</b>
	4-394025 Flection Serving Tray - Medium 30x20 cm Dark Stain Matt Lacquer Ash - FSC 100 %	2	<b>60</b>
	4-395020 Flection Serving Tray - Large 40x20 cm Oak - FSC 100 %	2	<b>66</b>
	4-395025 Flection Serving Tray - Large 40x20 cm Dark Stain Matt Lacquer Ash - FSC 100 %	2	<b>66</b>
	4-434001 Andersen Tray Holder - B59xD6 cm Cotton/Brass	6	<b>34</b>
	4-435021 Paper Towel Holder 2 - 31x9x3,2 cm Oak White Pigmented Matt Lacquer	2	<b>84</b>
	4-435025 Paper Towel Holder 2 - 31x9x3,2 cm Dark Stain Matt Lacquer Ash	2	<b>84</b>

## BATH







Item no.		Colli	Price per unit
	4-213021 Toilet Towel Holder - 13,5x8,5 cm Oak White Pigmented Matt Lacquer	2	<b>60</b>
	4-216021 Towel Grip - 13,5x9 cm Oak White Pigmented Matt Lacquer	2	<b>52</b>
	4-218021 Towel Rack Single - 73,5x7,5 cm Oak White Pigmented Matt Lacquer	2	<b>96</b>
	4-219021 Towel Rack Double - 73,5x13 cm Oak White Pigmented Matt Lacquer	2	<b>132</b>
	4-222021 Shelf 10 - 32x12 cm Oak White Pigmented Matt Lacquer	2	<b>72</b>
	4-223021 Shelf 11 - 44x12 cm Oak White Pigmented Matt Lacquer	2	<b>96</b>
	4-213025 Toilet Towel Holder - 13,5x8,5 cm Dark Stain Matt Lacquer Ash	2	<b>72</b>
	4-216025 Towel Grip - 13,5x9 cm Dark Stain Matt Lacquer Ash	2	<b>72</b>
	4-218025 Towel Rack Single - 73,5x7,5 cm Dark Stain Matt Lacquer Ash	2	<b>120</b>
	4-219025 Towel Rack Double - 73,5x13 cm Dark Stain Matt Lacquer Ash	2	<b>170</b>
	4-222025 Shelf 10 - 32x12 cm Dark Stain Matt Lacquer Ash	2	<b>90</b>
	4-223025 Shelf 11 - 44x12 cm Dark Stain Matt Lacquer Ash	2	<b>114</b>
	4-218002 Towel Rack Single - 73,5x7,5 cm Beech Black	2	<b>96</b>
	4-219002 Towel Rack Double - 73,5x13 cm Beech Black	2	<b>144</b>



## FURNITURE

Item no.		Colli	Price per unit	
	4-155001	Clothes Rack - Wood - 103xH183 cm Black	1	265
	4-155030	Clothes Rack - Wood - 103xH183 cm Ash	1	241
	4-156001	Rack Fittings Black	1	24
	4-156030	Rack Fittings Ash	1	24
	4-295020	Multi Mirror - 20,5x60xH146 cm	1	422
	4-148001	U1 Stool - Ø30x46,5 cm Black	1	216
	4-247020	B1 Bench - 40x80xH45 cm Oak Lacquer	1	457
	4-381020-FSC	B3 Bench - 40x120xH45 cm Oak White Matt Lacquer	1	604
	4-159030	Tray Table - Ø46 cm - Black Frame Ash	1	241
	4-361020	Donut Stool - Ø35xH45 cm Oak	1	120
	4-362020	Reach Stool - 35x25xH25 cm Oak	1	192
	4-389025	Connect Table - 50x35xH63 cm Oiled Nature Oak / Black Metal	2	180
	4-398520	Collect Mirror - Medium 64x3,5xH74cm Oak - FSC 100%	1	158
	4-399020	Collect Mirror - Large 60x3,5xH160cm Oak - FSC 100%	1	242

## FURNITURE

Item no.		Colli	Price per unit
	4-248020	Seat Stool - H45xD38xL46 cm Oak White Matt Lacquer/Cotton webbing	1 <b>168</b>
	4-249020	Seat Bench - H45xD38xL100 cm Oak White Matt Lacquer/Cotton webbing	1 <b>241</b>
	4-431001	Edge Side Table - 33x33xH51 cm Powder Coated Metal - Black	1 <b>242</b>
	4-436021	Plinth Stool - 30,7x49xH45 cm Oak Matt Lacquer	1 <b>278</b>
	4-438020	View TV Stand - 91,3x94,8xH50 cm Oak	1 <b>266</b>
	4-437021	Column Shoe Rack - 87x34xH41,5 cm Oak Matt Lacquer	1 <b>194</b>





Design Concept Denmark A/S | Zeta 1 | DK-8382 Hinnerup | +45 27 40 08 08  
info@designconceptdenmark.dk | andersen-furniture.dk