

ANDERSEN PRICELIST FURNITURE

EUR – RETAIL INCL. VAT

AUSTRIA – CZECH REPUBLIC – ESTONIA – FRANCE – LATVIA – LITHUANIA – ROMANIA – SLOVAKIA – SPAIN

VALID FROM 15.11.2023



ANDERSEN
QUALITY MEETS DESIGN

- A part of Design Concept Denmark

CONTENTS

General information	4	HC1 - Bar stool	96
Care kits	6	HC2 - Bar stool	97
TABLES	7	HC3 - Bar stool	98
AD1 - Series	9	LC1 - Lounge chair	99
AD1 - Tables	10	Mood - Chairs	100
AD1 - High tables	11	Mood 4-legs - Chair	101
AD1 - Extendable tables	12	Mood 4-legs - Arm chair	102
AD1 - Bench	13	Mood Tube - Chair	103
Andersen - High tables	14	Mood Tube - Arm chair	104
Classic 255 /290 - Extendable tables	16	Mood Low - Bar stool	105
Delta - Tables with bases	18	Mood High - Bar stool	106
DK10 - Extendable tables	21	Mood Conference - Chair	107
Grip - Tables	22	Mood Wood - Chair	108
Grip Basic - Tables	23	Mood Classic - Chair	109
Grip Metting - Tables	25	Mood Learn - Chair	110
Grip Wood - Tables	27	Mood Learn - Arm chair	111
Grip Powerbox	28	Mood Learn - Chair	112
Link - Tables	29	Must - Chair	113
Link Bar - Tables	34	Pure - Chairs	114
Link - Features / Accessories	35	Pure - Chair	115
Space - Tables	37	Pure - Stool / Bar stool	116
Space - High tables	40	Pure - Barstool	117
Space - Extendable tables	41	Pure X - Chair	118
Tube - Tables	42	Rail - Chairs	119
Tube - Collection	43	Rail - Chair	120
Tube - Weight Overview	45	Rail - Arm chair	121
Tube Basic - Tables	46	Rail - Bar stool	122
Tube Fold - Tables	50	Scope - Chairs	123
Tube Wood - Tables	54	Scope - Chair	124
Tube Counter - Tables	56	Scope - Arm chair	125
Tube Stay - Tables	57	Scope - Stool / Bar stool	126
Tube - Modesty Panel / End Panel	60	Scope - Lounge chair	127
Tube - Transport Trolley	60	TAC - Chairs	128
T1 - Series	61	Tono - Chairs	130
T1 - Tables	62	Tono 4-legs - Chair	131
HT1 - High tables	64	Tono Wood - Chair	132
T1 - Extendable tables	66	Tono Conference - Chair	133
B2 - Bench	67	Chair trolleys / Chair suspension	134
T3 - Extendable tables	68	SOFAS - DAYBED	135
T7 - Extendable tables	70	Fabric / Leather groups - Sofas	137
T8 - Tables	72	A1 Sofa & Pouf	138
T9 - Extendable tables	74	A2 - Sofa	139
T10 - Extendable table	76	A3 - Sofa	140
T11 - Extendable table	77	DB1 Arctic - Daybed	142
Solutions for cables & power	78	STORAGE	143
D1 - Desk	80	S1 - S2 Series	144
COFFEE TABLES	81	S1 - Sideboard	145
C1 - Coffee tables	82	S2 - Shelf system (Height 32 cm)	146
C2 - Coffee tables	84	S2 - Shelf system (Height 51 cm)	147
C6 - Coffee tables	85	S2 - Shelf system (TV-Modul)	148
C7 - Coffee tables	86	S3 - S5 - S6 - S7 - S8 Series	149
CHAIRS	87	S3 / S5 - Storage	150
Fabric overview - Chairs	89	S6 / S7 - Sideboard	151
AC2 - Chair	90	S8 - Storage	152
Dry - Chair	92	S10 Signature - Cabinets	153
Dry - Bar stool	94	Uniques - Sideboard & Highboard	154
Dry Outdoor - Chair	95	RUGS	155
		Flow - Rugs	157

GENERAL INFORMATION

Conditions of sale and terms of delivery:

This pricelist is valid from 15.11 2023 and will replace all previous pricelists.
Current sale terms should at all times be observed.

The order is registered and accepted when written order confirmation is present.
Confirmed delivery time is ex. works. It is the costumers responsibility to check order confirmations forwarded by Design Concept Denmark and thereby reassure that it is consistent with the order.
The pricelist is subject to alteration and misprints.

All orders require a credit approval equal to the total order amounts.
Design Concept Denmark may postpone delivery of any order or cancel orders in writing without incurring any liability for them if the buyer or companies or persons affiliated with the buyer have any unpaid overdue invoices relating to previously delivered orders or otherwise have any outstanding unpaid amounts.

We accept no liability for printing errors, image errors, price changes, discontinued goods or errors.

Environmental fee

All orders will be charged an EUR 11,- environmental fee.

Breach of sales colli

Breach of sales colli will be charged a fee of EUR 45,-

Transportinformation:

For orders lower than EUR 1.000,- net excl. VAT there will be a freight cost on EUR 125,-
Free shipping on orders above EUR 1.000,- net excl. VAT

The above freight condition will only include mainland. The freight condition will NOT apply to islands and the rest of the world – here we will calculate an actual freight charge.
Please note that we only ship to company addresses

Damage during transport:

If the goods are damaged during transportation, or a suspicion occurs, the goods MUST be examined and any damages reported to the forwarding agent immediately, therefore the packaging must be examined carefully when receiving the goods. Design Concept Denmark cannot be held responsible for transport damages that are reported after the deadline according to the carrier's conditions.

Complaints:

Agreement required for returning goods. When returning goods, the furniture damaged MUST be wrapped up securely.
Design Concept Denmark is not responsible for any transportation damages which are caused by inadequately packing.

If there is no visible damage to the packaging, transport damage must be reported no later than 7 days after receiving the goods
If an order has been transported further, all cover for nonvisible damage is waived. In case of missing number of colli and/ or packaging, this must be reported no later than 7 days after receiving the order.

GENERAL INFORMATION

Returning goods: Design Concept Denmark will pay the transport costs from/to Design Concept Denmark and the customer. If the claim hasn't been approved by Design Concept Denmark the customer pays for the transport. It is the customer's responsibility to inspect the claim together with a representative from Design Concept Denmark. Design Concept Denmark will make an assessment whether the claim shall be repaired or replaced. The customer cannot demand a refund by repairing the claim.

Limitations of liability:

Design Concept Denmark will assume no liability for any loss as a result of delays, defects or any other breach of contract, unless such loss was caused by gross negligence on the part of Design Concept Denmark. Design Concept Denmark will assume no liability for any indirect loss, including loss of profits, operating loss, goodwill, loss of customers, running costs or any other consequential economic loss.

Measurement:

Please note that a difference in measurement may occur.

Targets, Technical Information and Intellectual Rights:

Product information, illustrations, drawings, information on technical data (e.g. weight, dimensions, volume, strength, load capacity and surface), materials in catalogues, brochures or other materials are solely indicative. We reserve the right to modify specifications and descriptions without warning. All drawings and technical documents regarding products are the property of Design Concept Denmark and may not be copied, reproduced or disclosed to third parties.

Design Concept Denmark retains ownership of all intellectual property rights associated with the products, and the buyer does not obtain any right to make use of Design Concept Denmark's intellectual property rights above and beyond what may be necessary for the normal use of the purchased products.

Ownership

Design Concept Denmark shall retain the ownership rights to the delivered products until the buyer has paid the entire purchase amount in full plus any incurred costs.

Guarantee and liability:

Design Concept Denmark grants a 2-year guarantee on all products in our official price lists. The guarantee shall be voided if the product shows signs of misuse, improper handling or other physical damage.

No guarantee is provided for damage occurring as a result of incorrect fitting by a third-party fitter. Design Concept Denmark may never be held liable for indirect losses, such as operating losses, loss of profit, loss of income or other indirect losses, regardless of whether such losses are due to liability for defects, delays, products or similar.

The amount of Design Concept Denmark's liability for compensation is always limited to the amount of the order that gave rise to the liability for compensation.

Minor defect in the laminate can occur, which are within the supplier's tolerance and permitted values according to the European standard EN438. In addition a colour difference between table and leaves can occur.

Direct sunlight, heat, alcohol and moisture are bad for wooden furniture. Regardless of how the wood is treated, we therefore recommend limiting direct sunlight and avoiding direct contact with heat and moisture. For optimal treatment of the product, we refer to our treatment instructions.

CARE KITS

Care kits		Min. order quantity	Price
9-OL005L	White oil - No. 760 (bottle with 250 ml.)	12	40
9-OL005M	Natural oil - nature/dark - no. 244 (bottle 250 ml.)	12	40
9-100-006S	Care kit contain. 240 gr. white soapflakes, sand paper and sprong	12	35
9-100-008S	White soapflakes (bag 500 gr.)	8	20
9-100-007	Laminate cleaning (500 ml. bottle with spray)	12	25
9-100-009	Linoleum cleaning (500 ml. bottle with spray)	12	25
9-200	Repair lacquer	1	25

TABLES

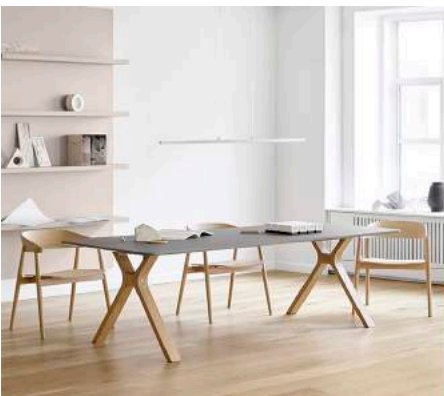

AD1 - SERIES

Design: Andersen Design Team

TABLE TOP - LAMINATE (HPL)



White (Alpino)
K1040



Kashmir
F0187



Cafe
F0903



Terril
F2297



Diamond Black
F2253



Ocean Grey
F7853



Pumice
F7858



Silver
F2791



Iron
F7902



Pale Olive
F3007



Artic Blue
F5493



Lead
F7924



Mouse
F7928

TABLE TOP - FENIX LAMINATE



Black (Nero Ingo)
0720



Bianco Male
0029



Beige Luxor
0719



Beige Arizona
0748



Castoro Ottawa
0717



Cacao Orinoco
0749



Grigio Efeso
0725



Grigio Antrim
0752



Grigio Londra
0718



Grigio Bromo
0724



Rosso Jaipur
0751



Verde Comodoro
0750



Blu Fes
0754

TABLE TOP - LINOLEUM



Black (Nero)
4023



Ash
4132



Burgundy
4154



Iron
4178



Mauve
4172



Mushrom
4176



Olive
4184



Orange Blast
4186



Pebble
4175



Pearl
4157



Pewter
4155



Pistachio
4183



Powder
4185



Salsa
4164



Smokey Blue
4179



Aquavert
4180



Spring Green
4182



Vapour
4177



Charcoal
4166



Conifer
4174



Midnight Blue
4181

LEGS / SUPPORTING FRAME



Oak

Whitepig. matt lacquer



AD1 - TABLES

Design: Andersen Design Team

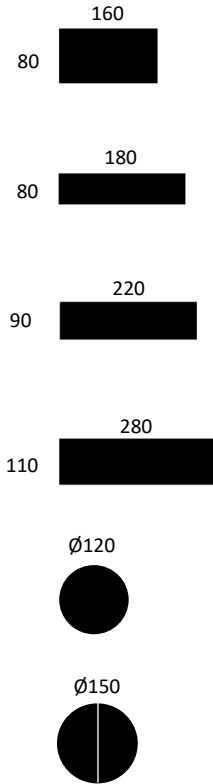

Table top	White Laminate (HPL)	Coloured Laminate (HPL)	Black Fenix Laminate *	Black Linoleum **
Edge	Edge whitepainted ***	Edge blackpainted ***	Edge blackpainted ***	Edge blackpainted ***
0-6001- 160x80xH74 cm				
Legs: Oak/Whitepig. matt lacquer	1.500	1.620	1.725	1.725
0-6003- 180x80xH74 cm				
Legs: Oak/Whitepig. matt lacquer	1.570	1.695	1.805	1.805
0-6005- 220x90xH74 cm				
Legs: Oak/Whitepig. matt lacquer	1.645	1.775	1.890	1.890
0-6007- 280x110xH74 cm				
Legs: Oak/Whitepig. matt lacquer	2.145	2.315	2.465	2.465
0-6020- Ø120xH74 cm				
Legs: Oak/Whitepig. matt lacquer	1.355	1.465	1.560	1.560
0-6040- Ø150xH74 cm				
Legs: Oak/Whitepig. matt lacquer	1.930	2.085	2.220	2.220

Surcharge

* Additional fee for other Fenix laminate colours than black: 15%

** Additional fee for other linoleum colours than black: 15%

*** Additional fee for edge in oak or edge painted in colour as laminate: 10%

Model 0-6001-



Model 0-6007-

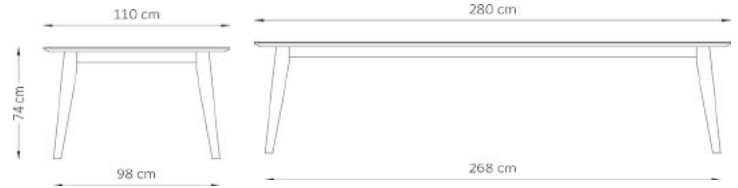

Model 0-6003-

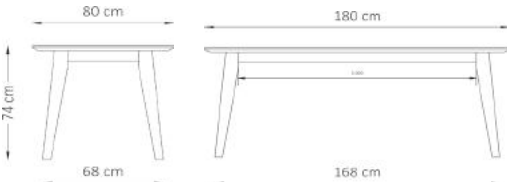

Model 0-6020-



Model 0-6005-



Model 0-6040-

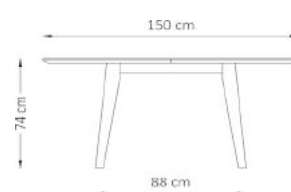



AD1 - HIGH TABLES

Design: Andersen Design Team

Tabletop	White Laminate (HPL)	Coloured Laminate (HPL)	Black Fenix Laminate*	Black Linoleum**
Edge	Edge whitepainted ***	Edge blackpainted ***	Edge blackpainted ***	Edge blackpainted ***

Height 93 cm

0-60702- 180x80xH93 cm

Legs: Oak/Whitepigm. matt lacquer

1.645

1.775

1.890

1.890

0-60712- 220x80xH93 cm

Legs: Oak/Whitepigm. matt lacquer

1.785

1.930

2.055

2.055

Height 105 cm

0-60701- 180x80xH105 cm

Legs: Oak/Whitepigm. matt lacquer

1.645

1.775

1.890

1.890

0-60711- 220x80xH105 cm

Legs: Oak/Whitepigm. matt lacquer

1.785

1.930

2.055

2.055

Surcharge

* Additional fee for other Fenix laminate colours than black: 15%

** Additional fee for other linoleum colours than black: 15%

*** Additional fee for edge in oak or edge painted in colour as laminate: 10%

Model 0-60702- / 0-60712-



Model 0-60702-



Model 0-60712-



Model 0-60701- / 0-60711-



Model 0-60701-

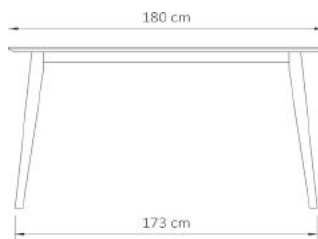

Model 0-60711-





AD1 - EXTENDABLE TABLE

Design: Andersen Design Team

Ø110



Table top	White Laminate (HPL)
Edge	White lacquered Bevelled
0-6010A Ø110xH74 cm Extension for 2 leaves	
Legs: Oak/Whitepigmented matt lacquer	1.715
Leaf 0-6011A 110x50 cm	
White laminate	310

PRODUCT HIGHLIGHTS

- W 32 kg / CBM 0,18





AD1 - BENCH

Design: Andersen Design Team

Seat	White Laminate (HPL)	Oak Whitepig. matt lacquer
------	-------------------------	-------------------------------

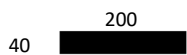

0-6320A1010213 200x40xH45 cm		
Legs: Oak/Whitepigmented matt lacquer	1.215	
0-6320M0213 200x40xH45 cm		
Legs: Oak/Whitepigmented matt lacquer		1.355

PRODUCT HIGHLIGHTS

- W 25 kg / CBM 0,10



ANDERSEN - HIGH TABLES

Design: Andersen Design Team

HIGH TABLE - LAMINATE (HPL)



White full coloured
001R

HIGH TABLE - FENIX LAMINATE



Black (Nero Ingo)
0720

HIGH TABLE - FINGERJOINTED SOLID OAK



Oak
Whitepig. matt lacquer



Oak
Clear matt lacquer



Oak
Black lacquer





ANDERSEN - HIGH TABLES

Design: Andersen Design Team

Tabletop	Solid white Laminate*	Black Fenix Laminate*	Oak Lacquer**
Edge	Edge whitepainted	Edge blackpainted	Oak edge lacquered

Height 93 cm Without footrest	Bevelled edge / Mitre		
-------------------------------	-----------------------	--	--

60 180	0-3710- 180x60xH93 cm	2.435	2.615	2.490
80 180	0-3715- 180x80xH93 cm	3.190	3.545	2.500
60 240	0-3720- 240x60xH93 cm	2.490	2.665	2.770
80 240	0-3725- 240x80xH93 cm	3.220	3.575	2.780

Height 108 cm With footrest	Bevelled edge / Mitre		
-----------------------------	-----------------------	--	--

60 180	0-3810- 180x60xH108 cm	2.790	3.060	2.845
80 180	0-3815- 180x80xH108 cm	3.470	3.825	2.865
60 240	0-3820- 240x60xH108 cm	2.930	3.200	3.265
80 240	0-3825- 240x80xH108 cm	3.575	3.930	3.275
60 295	0-3830- 295x60xH108 cm	3.010	3.305	3.585
80 295	0-3835- 295x80xH108 cm	3.615	3.995	3.595

Laminate on 28 mm MDF

** Choose between surface in: White pigmented matt lacquer / Clear matt lacquer / Black lacquer

PRODUCT HIGHLIGHTS

- The footrest is covered in a stainless steel cap.

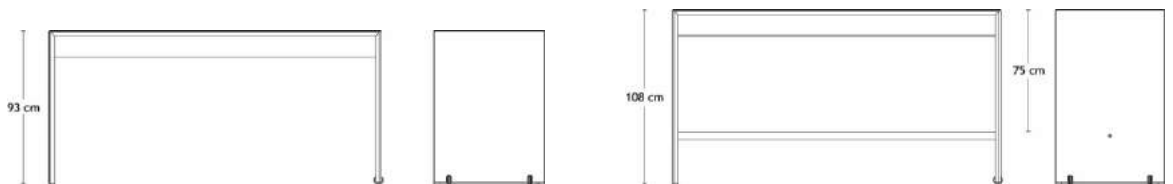

CLASSIC 255 / 290 - EXTENDABLE TABLES

Design: Andersen Design Team

TABLE TOP & LEGS - SOLID OK



Oak
White oil



Oak
Natural oil



Oak
Soap

Edge - Choose between:



Full rounded edge B



Bevelled edge C

Model 2-255L / 2-255XL

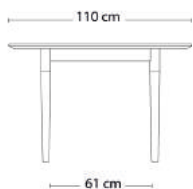

Model 2-255L

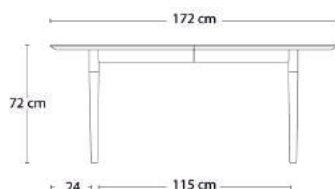

Model 2-255XL

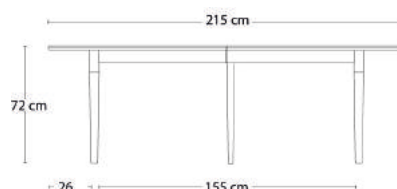

Model 2-265 / 2-265XL

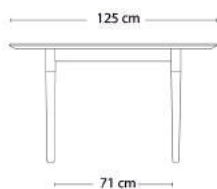

Model 2-265

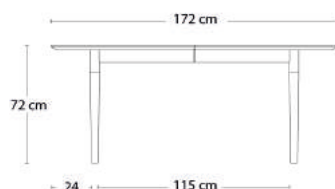

Model 2-265XL

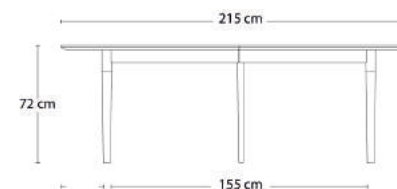

Model 2-290

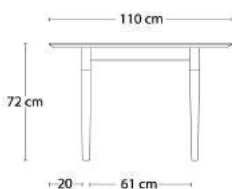

2-295

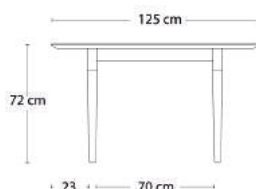



CLASSIC 255 / 290 - EXTENDABLE TABLES

Design: Andersen Design Team

Tabletop and legs in solid wood

Oak
Soap

Oak
Oil *

The tables has an extension for 3 leaves. Can be supplied with extra extension at an additional cost

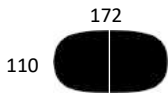

2-255L 110x172xH72 cm

Possibility of extension for max. 8 leaves

Oak

3.150

3.290

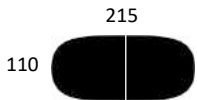

2-255XL 110x215xH72 cm

Possibility of extension for max. 8 leaves

Oak

3.580

3.720

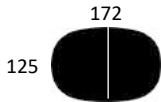

2-265 125x172xH72 cm

Possibility of extension for max. 8 leaves

Oak

3.150

3.290

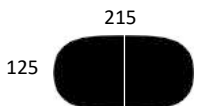

2-265XL 125x215xH72 cm

Possibility of extension for max. 8 leaves

Oak

3.580

3.720

Ø110



2-290 Ø110xH72 cm

Possibility of extension for max. 5 leaves

Oak

2.860

3.005

Ø125



2-295 Ø125xH72 cm

Possibility of extension for max. 5 leaves

Oak

3.005

3.150

Leaves

Anthracite
grey

Oak
Soap

Oak
Oil

Leaf for model 2-255 / 2-290

2-256 110x50 cm

925

1.000

2-257 110x50 cm

395

Leaf for model 2-265 / 2-295

2-296 125x50 cm

925

1.000

2-297 125x50 cm

425

Surcharge - Extra extension

For 4
leaves

For 5 eller
6 leaves

For 7 eller
8 leaves

400

540

635

Surcharge - Table height 74 cm

145

Surcharge - Supporting leg in oak (per leg)

35

* Oak/Oil - Choose between: White oil - Natural oil

PRODUCT HIGHLIGHTS

- Model 255L: W 60 kg / CBM 0,22

- Model 255XL: W 70 kg / CBM 0,27

- Model 265L: W 60 kg / CBM 0,25

- Model 265XL: W 80 kg / CBM 0,33

- Model 290: W 55 kg / CBM 0,15

- Model 295: W 55 kg / CBM 0,15

DELTA - TABLES WITH BASES

Design: Andersen Design Team

TABLE TOP - FENIX LAMINATE



Black (Nero Ingo)
0720



Castoro Ottawa
0717



Verde Comodoro
0750

TABLE TOP - LINOLEUM



Black (Nero)
4023



Ash
4132



Burgundy
4154



Iron
4178



Mauve
4172



Mushrom
4176



Olive
4184



Orange Blast
4186



Pebble
4175



Pearl
4157



Pewter
4155



Pistachio
4183



Powder
4185



Salsa
4164



Smokey Blue
4179



Aquavert
4180



Spring Green
4182



Vapour
4177



Charcoal
4166



Conifer
4174



Midnight Blue
4181

BASE



Black matt powder coated
RAL 9005



DELTA - TABLES WITH BASES (HEIGHT 73 CM)

Design: Andersen Design Team

Tabletop	Fenix Laminate	Linoleum
Edge	Straight edge ABS / Colour as tabletop	Straight edge Linoleum as tabletop
DE-101- 70 x 70 x H73 cm Table top 70x70 cm with Delta base 40x40 cm	760	735
DE-102- 80 x 80 x H73 cm Table top 80x80 cm with Delta base 40x40 cm	805	760
DE-103- 90 x 90 x H73 cm Table top 90x90 cm with Delta base 40x40 cm	845	775
DE-110- 120 x 70 x H73 cm Table top 120x70 cm with Delta base 60x40 cm	805	790
DE-111- 120 x 80 x H73 cm Table top 120x80 cm with Delta base 60x40 cm	875	805
DE-120- Ø80 x H73 cm Table top Ø80 cm with Delta base Ø45 cm	820	775
DE-121- Ø90 x H73 cm Table top Ø90 cm with Delta base Ø45 cm	860	790
DE-122- Ø100 x H73 cm Table top Ø100 cm with Delta base Ø57 cm	1.005	920
DE-123- Ø110 x H73 cm Table top Ø110 cm with Delta base Ø57 cm	1.150	975

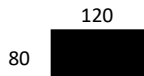
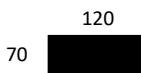
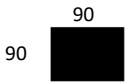
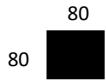

Height 73 cm

40x40 cm

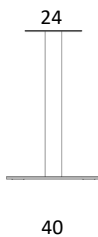

60x40 cm

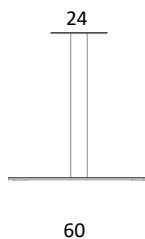

Ø45 cm

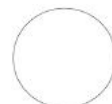
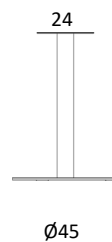



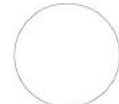
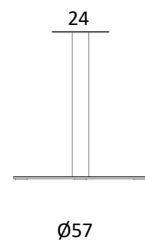



Ø57 cm



DELTA - TABLES WITH BASES (HEIGHT 107 CM)

Design: Andersen Design Team

Tabletop		Fenix Laminate	Linoleum
Edge		Straight edge ABS / Colour as tabletop	Straight edge Linoleum as tabletop
70 	DE-201- 70 x 70 x H107 cm Table top 70x70 cm with Delta base 40x40 cm	795	770
80 	DE-202- 80 x 80 x H107 cm Table top 80x80 cm with Delta base 40x40 cm	840	795
90 	DE-203- 90 x 90 x H107 cm Table top 90x90 cm with Delta base 40x40 cm	885	810
Ø80 	DE-220- Ø80 x H107 cm Table top Ø80 cm with Delta base Ø45 cm	855	775
Ø90 	DE-221- Ø90 x H107 cm Table top Ø90 cm with Delta base Ø45 cm	900	790
Ø100 	DE-222- Ø100 x H107 cm Table top Ø100 cm with Delta base Ø57 cm	1.040	920

Height 107 cm

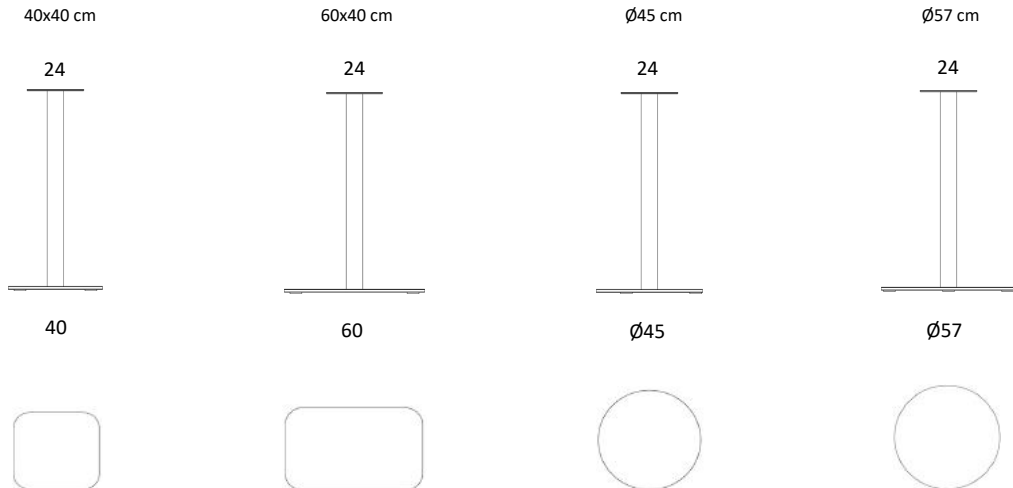

DK10 - EXTENDABLE TABLES

Design: Ditlev Karsten



Tabletop in laminate	Solid white Laminate
Edge	Edge whitepainted

0-8220 110x190xH72 cm Extension for 3 leaves	
Legs in chromed steel	2.575

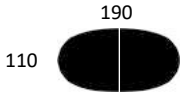

0-8225 110x190xH72 cm Extension for 3 leaves	
Oak/Soap legs	2.575
Oak/Oil (Whiteoil/Natural oil) legs	2.575



Leaf	Solid white Laminate
------	----------------------

Leaf 0-8290 50x110 cm	410
---------------------------------	------------

Table legs	Chrome	Oak/Soap	Oak/Oil	Table top	White Laminate
-------------------	--------	----------	---------	------------------	----------------



Table top and legs in solid oak	Oak Soap	Oak Natural oil
--	----------	-----------------

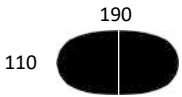

0-8230 110x190xH72 cm Extension for 3 leaves	
Oak	2.720 2.860

Leaf	Anthracite grey lacquered	Oak Soap	Oak Natural oil
------	---------------------------	----------	-----------------

Leaf 0-8294 50x110 cm	325		
0-8293 50x110 cm		710	785

Table top / Legs	Oak/Soap	Oak/Natural oil
-------------------------	----------	-----------------

PRODUCT HIGHLIGHTS

Model 2-5702: W 68 kg / CBM 0,27

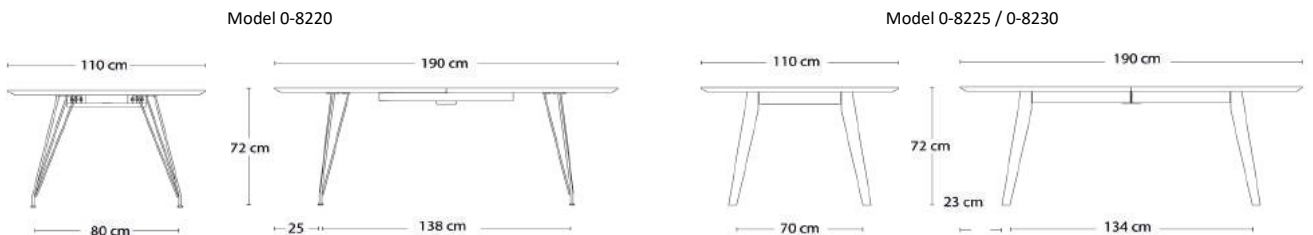

GRIP - TABLES

Design: Troels Grum-Schwensen

TABLE TOP - LAMINATE (HPL)



White
NCS S500-N



Light Grey
F7961

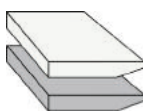

Edge profile chamfered - Lacquered

TABLE TOP - FENIX LAMINATE



Black (Nero Ingo)
0720



Grigio Londra
0718

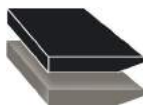

Edge profile chamfered - Lacquered

TABLE TOP - LINOLEUM



Black (Nero)
4023



Edge profile chamfered - Lacquered

TABLE TOP - VENEER



Oak
Veneer



Edge profile chamfered - Lacquered

FRAME COLOURS - GROUP 1



Black
RAL 9005

FRAME COLOURS - GROUP 2



Dark Petrol
NCS 7010 B10G



Dusty Light Blue
NCS 3010 B10G



Dusty Green
NCS S6010 G10Y



Dusty Pink
NCS S2020 Y80R



Light Sandy Grey
RAL 7042



Sandy Grey
NCS 5502Y



Dusty Olive
RAL 7009



Terracotta
RAL 8002



Warm Charcoal
RAL 7022



GRIP BASIC - TABLES

Design: Troels Grum-Schwensen

Frame	Frame black Lacquered**	Frame colour Lacquered**
Edge	Edge profile chamfered lacquered	

G69100 - Table 131 x 80 cm, 2 legs

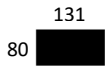

HPL laminate	1.965	2.043
Fenix laminate	2.114	2.194
Linoleum	2.055	2.135
Veneer*	2.260	2.348

G69110 - Table 179 x 80 cm, 2 legs

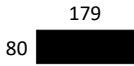

HPL laminate	2.053	2.133
Fenix laminate	2.264	2.346
Linoleum	2.141	2.223
Veneer*	2.356	2.445

G69120 - Table 239 x 80 cm, 2 legs

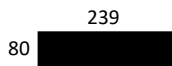

HPL laminate	2.348	2.576
Fenix laminate	2.623	2.820
Linoleum	2.465	2.703
Veneer*	2.711	2.804

G69130 - Table 299 x 80 cm, 2 legs

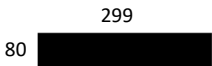

HPL laminate	2.773	2.947
Fenix laminate	3.050	3.269
Linoleum	2.900	3.169
Veneer*	3.068	3.169

Surcharge

G69900 - GRIP leg	474	529
G69500 - GRIP linking device		129

*Please note deviation in colour and grain may occur and we cannot recommend linking veneer tables. Other finishes and colours are available upon request, please contact our sales office.

Choice of other colours: Formica Colors and Forbo Linoleum + 10%

Frame colour

**Lacquered



Dark
Petrol



Dusty
Light Blue



Dusty
Green



Dusty
Pink



Light
Sandy
Grey



Sandy
Grey



Dusty
Olive



Terra-
cotta



Warm
Charcoal

PRODUCT HIGHLIGHTS

- Modular construction - the table can be expanded and linked
- Removable legs, allows you to adjust positioning to meet individual needs
- Media integration is available - Grip powerbox
- Extremely stable frame construction
- Up to 3m span between the legs
- Top depth: 80 cm
- Top thickness: 20mm
- Height: 73,5 cm



GRIP BASIC - TABLES

Design: Troels Grum-Schwensen

Frame	Frame black Lacquered**	Frame colour Lacquered**
Edge	Edge profile chamfered lacquered	

G69140 - 3 legs, table top in 2 parts (2 x 179 cm)

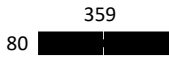

HPL laminate	3.755	3.884
Fenix laminate	4.178	4.313
Linoleum	3.934	4.065
Veneer*	4.327	4.473

G69150 - 4 legs, table top in 3 parts (2 x 131, 1 x 179 cm)

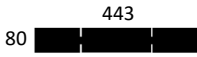

HPL laminate	5.281	5.457
Fenix laminate	5.792	5.974
Linoleum	5.545	5.726
Veneer*	6.101	6.300

G69160 - 3 legs, table top in 2 parts (2 x 239 cm)



HPL laminate	4.514	4.748
Fenix laminate	4.895	5.293
Linoleum	4.668	5.002
Veneer*	5.035	5.191

G69170 - 4 legs, table top in 3 parts (2 x 131, 1 x 299 cm)

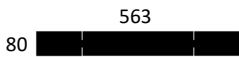

HPL laminate	5.865	6.171
Fenix laminate	6.513	6.708
Linoleum	6.194	6.511
Veneer*	6.813	7.022

G69180 - 3 legs, table top in 2 parts (2 x 299 cm)

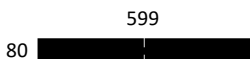

HPL laminate	5.125	5.533
Fenix laminate	5.792	6.187
Linoleum	5.537	5.915
Veneer*	5.746	5.915

Surcharge

G69900 - GRIP leg	474	529
G69500 - GRIP linking device		129

*Please note deviation in colour and grain may occur and we cannot recommend linking veneer tables. Other finishes and colours are available upon request, please contact our sales office.

Choice of other colours: Formica Colors and Forbo Linoleum + 10%

Frame colour

**Lacquered



Dark
Petrol



Dusty
Light Blue



Dusty
Green



Dusty
Pink



Light
Sandy
Grey



Sandy
Grey



Dusty
Olive



Terra-
cotta



Warm
Charcoal

PRODUCT HIGHLIGHTS

- Modular construction - the table can be expanded and linked
- Removable legs, allows you to adjust positioning to meet individual needs
- Media integration is available - Grip powerbox
- Extremely stable frame construction
- Up to 3m span between the legs
- Top depth: 80 cm
- Top thickness: 20mm
- Height: 73,5 cm



GRIP MEETING - TABLES

Design: Troels Grum-Schwensen

Frame	Frame black Lacquered**	Frame colour Lacquered**
Edge	Edge profile chamfered lacquered	

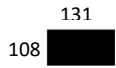

G69200 - Table 131 x 108 cm, 2 legs

HPL laminate	2.350	2.432
Fenix laminate	2.553	2.639
Linoleum	2.486	2.572
Veneer*	2.734	2.828

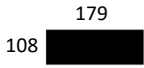

G69210 - Table 179 x 108 cm, 2 legs

HPL laminate	2.527	2.613
Fenix laminate	2.947	3.039
Linoleum	2.650	2.738
Veneer*	2.914	3.013

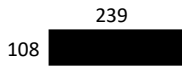

G69220 - Table 239 x 108 cm, 2 legs

HPL laminate	2.959	3.175
Fenix laminate	3.331	3.499
Linoleum	3.123	3.380
Veneer*	3.435	3.540

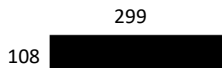

G69230 - Table 299 x 108 cm, 2 legs

HPL laminate	3.525	3.698
Fenix laminate	3.856	4.161
Linoleum	3.702	3.956
Veneer*	3.954	4.067

Surcharge

G69900 - GRIP leg	474	529
G69500 - GRIP linking device		129

*Please note deviation in colour and grain may occur and we cannot recommend linking veneer tables. Other finishes and colours are available upon request, please contact our sales office.

Choice of other colours: Formica Colors and Forbo Linoleum + 10%

Frame colour

**Lacquered



Dark
Petrol



Dusty
Light Blue



Dusty
Green



Dusty
Pink



Light
Sandy
Grey



Sandy
Grey



Dusty
Olive



Terra-
cotta



Warm
Charcoal

PRODUCT HIGHLIGHTS

- Modular construction - the table can be expanded and linked
- Removable legs, allows you to adjust positioning to meet individual needs
- Media integration is available - Grip powerbox
- Extremely stable frame construction
- Up to 3m span between the legs
- Top depth: 108 cm
- Top thickness: 20 mm
- Height: 74,5 cm



GRIP MEETING - TABLES

Design: Troels Grum-Schwensen

Frame	Frame black Lacquered**	Frame colour Lacquered**
Edge	Edge profile chamfered lacquered	



G69240 - 3 legs, table top in 2 parts (2 x 179 cm)

HPL laminate	4.701	4.844
Fenix laminate	5.267	5.418
Linoleum	4.947	5.094
Veneer*	5.441	5.605

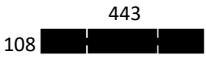

G69250 - 4 legs, table top in 3 parts (2 x 131, 1 x 179 cm)

HPL laminate	6.522	6.717
Fenix laminate	7.211	7.418
Linoleum	6.918	7.121
Veneer*	7.611	7.832



G69260 - 3 legs, table top in 2 parts (2 x 239 cm)

HPL laminate	5.566	5.954
Fenix laminate	6.310	6.610
Linoleum	5.892	6.358
Veneer*	6.483	6.661

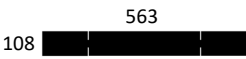

G69270 - 4 legs, table top in 3 parts (2 x 131, 1 x 299 cm)

HPL laminate	7.383	7.592
Fenix laminate	8.259	8.482
Linoleum	7.861	8.078
Veneer*	8.646	8.886

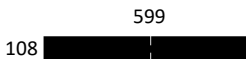

G69280 - 3 legs, table top in 2 parts (2 x 299 cm)

HPL laminate	6.684	6.993
Fenix laminate	7.432	7.924
Linoleum	7.108	7.574
Veneer*	7.518	7.715

Surcharge

G69900 - GRIP leg	474	529
G69500 - GRIP linking device		129

*Please note deviation in colour and grain may occur and we cannot recommend linking veneer tables. Other finishes and colours are available upon request, please contact our sales office.

Choice of other colours: Formica Colors and Forbo Linoleum + 10%

Frame colour

**Lacquered



Dark
Petrol



Dusty
Light Blue



Dusty
Green



Dusty
Pink



Light
Sandy
Grey



Sandy
Grey



Dusty
Olive



Terra-
cotta



Warm
Charcoal

PRODUCT HIGHLIGHTS

- Modular construction - the table can be expanded and linked
- Removable legs, allows you to adjust positioning to meet individual needs
- Media integration is available - Grip powerbox
- Extremely stable frame construction
- Up to 3m span between the legs
- Top depth: 108 cm
- Top thickness: 20 mm
- Height: 74,5 cm



GRIP WOOD - TABLES

Design: Troels Grum-Schwensen

Frame	Frame black Lacquered**	Frame colour Lacquered**
Edge	Edge profile chamfered	
G69310 - Table 179 x 100 cm, 2 legs		
White oiled oak*	4.141	4.338
G69320 - Table 239 x 100 cm, 2 legs		
White oiled oak*	5.002	5.127
G69330 - Table 299 x 100 cm, 2 legs		
White oiled oak*	6.639	6.788
Surcharge		
G69900 - GRIP leg	482	529

*Please note deviation in colour and grain may occur and we cannot recommend linking the tables.

Other finishes and colours are available upon request, please contact our sales office.

Choice of other colours: Formica Colors and Forbo Linoleum + 10%

Frame colour

**Lacquered



Dark
Petrol



Dusty
Light Blue



Dusty
Green



Dusty
Pink



Light
Sandy
Grey



Sandy
Grey



Dusty
Olive



Terra-
cotta



Warm
Charcoal

PRODUCT HIGHLIGHTS

- Tabletop in solid wood
- Modular construction - the table can be expanded and linked
- Removable legs, allows you to adjust positioning to meet individual needs
- Extremely stable frame construction
- Up to 3 m span between the legs
- Top depth: 100 cm
- Top thickness: 25 mm
- Height: 74 cm

GRIP POWERBOX

PBOXL-MODA-xx

1xHDMI 2.0, 1xPDS Cat6 UTP, 1xUSB charger A+C, 1 xUSB charger C+C, 3x230V Schuko (Incl. Cut-out and lid)

450 x 50 x 52 mm

1.220

G69550

Cut-out incl. alu-lid, excl. powerbox

457

Powerbox only available for GRIP Basic and GRIP Meeting

PRODUCT HIGHLIGHTS

- Only available on Grip Basic and Grip Meeting
- With aluminum lid
- Can be equipped individually
- With 3 m. cable



LINK - TABLES

Design: Hans-Thyge & Co.

TABLE TOP - LINOLEUM



Black (Nero)
4023



Ash
4132



Mushrom
4176

LEGS / RAIL / EDGE



Oak
White tinted



Oak
Black Lacquered

METAL ON LEG CONSTRUCTION



Black
RAL 9005





LINK - TABLES

Design: Hans-Thyge & Co.



Frame	Frame colour	Frame colour
	Slightly white-tinted oak	Black lacquered oak
L120070		
Table top 70 x 120 cm, no legs		
Linoleum*		
Slightly white-tinted lacquered oak edge	1.235	
Black lacquered oak edge		1.235
L120140		
Table 140 x 120 cm, 2 pair of legs		
Linoleum*		
Slightly white-tinted lacquered oak edge	2.785	
Black lacquered oak edge		2.785
L120145		
Table 145 x 120 cm, 2 pair of legs		
Linoleum*		
Slightly white-tinted lacquered oak edge	2.941	
Black lacquered oak edge		2.941
L120200		
Table 200 x 120 cm, 2 pair of legs		
Linoleum*		
Slightly white-tinted lacquered oak edge	3.121	
Black lacquered oak edge		3.121
L120120		
Table diagonal dimensions 130 cm, with fixed legs		
Linoleum*		
Slightly white-tinted lacquered oak edge	2.201	
Black lacquered oak edge		2.201

Other Linoleum colours are available upon request, please contact our sales office.

Table top

*Linoleum

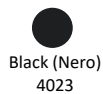

PRODUCT HIGHLIGHTS

- Large range of modules
- User-friendly linking system
- Solid wooden beam and legs
- Linoleum table top in various colours
- Suitable for wide variety of public spaces
- Knock down construction, flat packed
- Also available as bar/counter/round/boat shape
- Moveable and flexible leg position
- Wooden parts available in two colours
- High stability
- Table top 2 cm.
- Height 73,5 cm.



LINK - TABLES

Design: Hans-Thyge & Co.



Frame	Frame colour	Frame colour
	Slightly white-tinted oak	Black lacquered oak

L120280

3 pair of legs, table top in 2 parts (2 x 140 cm)

Linoleum*

Slightly white-tinted lacquered oak edge

5.121

Black lacquered oak edge

5.121

L120340

3 pair of legs, table top in 2 parts (140 + 200 cm)

Linoleum*

Slightly white-tinted lacquered oak edge

5.457

Black lacquered oak edge

5.457

L120350

4 pair of legs, table top in 3 parts (140 + 70 + 140 cm)

Linoleum*

Slightly white-tinted lacquered oak edge

6.895

Black lacquered oak edge

6.895

L120400

3 pair of legs, table top in 2 parts (2 x 200 cm)

Linoleum*

Slightly white-tinted lacquered oak edge

5.794

Black lacquered oak edge

5.794

L120480

4 pair of legs, table top in 3 parts (140 + 200 + 140 cm)

Linoleum*

Slightly white-tinted lacquered oak edge

7.793

Black lacquered oak edge

7.793

Other Linoleum colours are available upon request, please contact our sales office.

Table top

*Linoleum

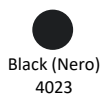

PRODUCT HIGHLIGHTS

- Large range of modules
- User-friendly linking system
- Solid wooden beam and legs
- Linoleum table top in various colours
- Suitable for wide variety of public spaces
- Knock down construction, flat packed
- Also available as bar/counter/round/boat shape
- Moveable and flexible leg position
- Wooden parts available in two colours
- High stability
- Table top 2 cm.



LINK - TABLES

Design: Hans-Thyge & Co.



Frame	Frame colour	Frame colour
	Slightly white-tinted oak	Black lacquered oak

L120285

3 pair of legs, table top in 2 parts (140 + 145 cm)

Linoleum*

Slightly white-tinted lacquered oak edge

5.277

Black lacquered oak edge

5.277



L120290

3 legs, table top in 2 parts (2 x 145 cm)

Linoleum*

Slightly white-tinted lacquered oak edge

5.435

Black lacquered oak edge

5.435

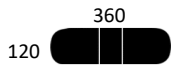

L120360

4 legs, table top in 3 parts (145 + 70 + 145 cm)

Linoleum*

Slightly white-tinted lacquered oak edge

7.209

Black lacquered oak edge

7.209

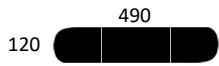

L120490

4 legs, table top in 3 parts (140 + 200 + 140 cm)

Linoleum*

Slightly white-tinted lacquered oak edge

8.107

Black lacquered oak edge

8.107

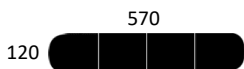

L120570

5 pair of legs, table top in 4 parts (145 + 2 x 140 + 145 cm)

Linoleum*

Slightly white-tinted lacquered oak edge

10.107

Black lacquered oak edge

10.107

Other Linoleum colours are available upon request, please contact our sales office.

Table top

*Linoleum

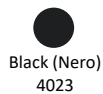

PRODUCT HIGHLIGHTS

- Large range of modules
- User-friendly linking system
- Solid wooden beam and legs
- Linoleum table top in various colours
- Suitable for wide variety of public spaces
- Knock down construction, flat packed
- Also available as bar/counter/round/boat shape
- Moveable and flexible leg position
- Wooden parts available in two colours
- High stability
- Table top 2 cm.
- Height 73,5 cm.



LINK - TABLES

Design: Hans-Thyge & Co.

	Frame	Frame colour Slightly white-tinted oak	Frame colour Black lacquered oak
<p>140 90</p>	L090140 Table 140 x 90 cm, 2 pair of legs Linoleum* Slightly white-tinted lacquered oak edge Black lacquered oak edge	2.336	2.336
<p>200 90</p>	L090200 Table 200 x 90 cm, 2 pair of legs Linoleum* Slightly white-tinted lacquered oak edge Black lacquered oak edge	2.785	2.785
<p>280 90</p>	L090280 3 pair of legs, table top in 2 parts (2 x 140 cm) Linoleum* Slightly white-tinted lacquered oak edge Black lacquered oak edge	4.223	4.223
<p>340 90</p>	L090340 3 pair of legs, table top in 2 parts (140 + 200 cm) Linoleum* Slightly white-tinted lacquered oak edge Black lacquered oak edge	4.672	4.672
<p>400 90</p>	L090400 3 pair of legs, table top in 2 parts (2 x 200 cm) Linoleum* Slightly white-tinted lacquered oak edge Black lacquered oak edge	5.121	5.121

Other Linoleum colours are available upon request, please contact our sales office.

Table top

*Linoleum

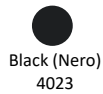

PRODUCT HIGHLIGHTS

- Large range of modules
- User-friendly linking system
- Solid wooden beam and legs
- Linoleum table top in various colours
- Suitable for wide variety of public spaces
- Knock down construction, flat packed
- Also available as bar/counter/round/boat shape
- Moveable and flexible leg position
- Wooden parts available in two colours
- High stability
- Table top 2 cm.
- Height 73,5 cm.



LINK BAR - TABLES

Design: Hans-Thyge & Co.

Frame		Frame colour	Frame colour
		Slightly white-tinted oak	Black lacquered oak
LC070140			
Table 140 x 70 cm, 2 pair of legs			
Height 92 cm.			
70	140	Slightly white-tinted lacquered oak edge	2.527
	H92	Black lacquered oak edge	2.527
LC070200			
Table 200 x 70 cm, 2 pair of legs			
Height 92 cm.			
70	200	Slightly white-tinted lacquered oak edge	2.672
	H92	Black lacquered oak edge	2.672
LB070140			
Table 140 x 70 cm, 2 pair of legs			
Height 105 cm.			
70	140	Slightly white-tinted lacquered oak edge	2.617
	H105	Black lacquered oak edge	2.617
LB070200			
Table 200 x 70 cm, 2 pair of legs			
Height 105 cm.			
70	200	Slightly white-tinted lacquered oak edge	2.762
	H105	Black lacquered oak edge	2.762

Other Linoleum colours are available upon request, please contact our sales office.

Table top



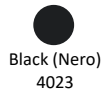







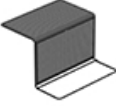

*Linoleum



PRODUCT HIGHLIGHTS

- Bar table
- Linoleum table top in various colours
- Solid wooden beam and legs
- Wooden parts available in two colours
- High stability
- Table top 2 cm.

LINK FEATURES / ACCESSORIES

	Price
	LGVL Pair of legs
	White tinted oak 494
	Black oak 12
	L-TSKUF Solid oak drawer
	White tinted oak 414
	Black oak 12
	L-IMPULT Standing desk
	Black 336
	L-MBAK Metal tray
	Black 135
	L-KOBL Linking device (set)
	Black 45
	L-PBOXR1 Frame for powerbox, single (incl. cut-out and lid)
	Black 371
	L-PBOXR2 Frame for powerbox, double (incl. cut-out and lid)
	Black 691
	L-PBOXA Powerbox, 3 x 230 V incl. 3 m. cord
	Black 148
	L-PBOXB Powerbox, 2 x 230 V, 2 x HDMI 2.0 incl. 3 m. cord
	Black 219
	L-PBOXC Powerbox, 2 x 230 V, 2 x Cat 6A incl. 3 m. cord
	Black 230
	L-PBOXD Powerbox, 2 x 230 V, 1 x USB A+C, 22 W incl. 3 m. cord
	Black 449
	L-PBOXE Powerbox, 2 x 230 V, 1 x USB C, 30 W incl. 3 m. cord
	Black 420

LINK FEATURES / ACCESSORIES



L-PBOXK
230 V extension cord (1 per powerbox) 3 meter

Black

25



L-PBOXKS
Cable sock 3 meter

Black

119

SPACE - TABLES

Design: Andersen Design Team

TABLE TOP - LAMINATE (HPL)



White (Alpino)
K1040



Kashmir
F0187



Cafe
F0903



Terril
F2297



Diamond Black
F2253



Ocean Grey
F7853



Pumice
F7858



Silver
F2791



Iron
F7902



Pale Olive
F3007



Artic Blue
F5493



Lead
F7924



Mouse
F7928

TABLE TOP - FENIX LAMINATE



Black (Nero Ingo)
0720



Bianco Male
0029



Beige Luxor
0719



Beige Arizona
0748



Castoro Ottawa
0717



Cacao Orinoco
0749



Grigio Efeso
0725



Grigio Antrim
0752



Grigio Londra
0718



Grigio Bromo
0724



Rosso Jaipur
0751



Verde Comodoro
0750



Blu Fes
0754

TABLE TOP - LINOLEUM



Black (Nero)
4023



Ash
4132



Burgundy
4154



Iron
4178



Mauve
4172



Mushrom
4176



Olive
4184



Orange Blast
4186



Pebble
4175



Pearl
4157



Pewter
4155



Pistachio
4183



Powder
4185



Salsa
4164



Smokey Blue
4179



Aquavert
4180



Spring Green
4182



Vapour
4177



Charcoal
4166



Conifer
4174



Midnight Blue
4181

TABLE TOP - OAK VENEER



Oak
Whitepig. matt lacquer



Oak
Clear matt lacquer

LEGS / SUPPORTING FRAME



Oak
Whitepig. matt lacquer



Oak
Clear matt lacquer



Oak
Black lacquer

SPACE - TABLES

Design: Andersen Design Team

Table top	Oak veneer Lacquer	White Laminate (HPL)	Coloured Laminate (HPL)	Black Fenix Laminate*	Black Linoleum**
Edge	Edge in oak	Edge blackpainted***	Edge blackpainted***	Edge blackpainted***	Edge blackpainted***

Legs in oak - choose between: Whitepigmented matt lacquer / Clear matt lacquer / Black lacquer

Width 90 cm

0-7403-	180x90xH74 cm	2.855	2.100	2.250	2.555	2.555
0-7405-	220x90xH74 cm	3.005	2.250	2.405	2.705	2.705

Width 120 cm

0-7505-	220x120xH74 cm	3.155	2.405	2.555	2.855	2.855
0-7507-	240x120xH74 cm	3.305	2.555	2.705	3.005	3.005
0-7509-	295x120xH74 cm	3.455	2.705	2.855	3.155	3.155
0-7513-	360x120xH74 cm	2 table tops / 3 legs	5.110	3.905	4.210	4.660
0-7517-	420x120xH74 cm	2 table tops / 3 legs	6.765	5.260	5.715	6.165
0-7519-	480x120xH74 cm	2 table tops / 4 legs	6.915	5.410	5.855	6.315

Width 140 cm

0-7613-	360x140xH74 cm	3 table tops / 3 legs	5.865	4.510	4.810	5.260
0-7617-	420x140xH74 cm	4 table tops / 3 legs	7.220	5.865	6.165	6.615
0-7619-	480x140xH74 cm	4 table tops / 4 legs	7.670	6.015	6.315	6.915

Width 160 cm

0-7713-	360x160xH74 cm	3 table tops / 3 legs	6.915	4.960	5.410	6.315
0-7717-	420x160xH74 cm	4 table tops / 3 legs	9.175	6.315	7.065	8.270
0-7719-	480x160xH74 cm	4 table tops / 4 legs	9.475	6.465	7.220	8.570

Round tables

0-7815-	Ø90xH74 cm	3 legs	1.950	1.500	1.650	1.800
0-7817-	Ø110xH74 cm	4 legs	2.250	1.800	1.950	2.100
0-7820-	Ø120xH74 cm	4 legs	2.555	1.950	2.100	2.250
0-7830-	Ø140xH74 cm	2 pieces/4 legs	3.305	2.705	2.855	3.005

Surcharge

* Additional fee for other Fenix laminate colours than black: 15%

** Additional fee for other linoleum colours than black: 15%

*** Additional fee for edge in oak or edge painted in colour as laminate: 10%

PRODUCT HIGHLIGHTS

- Possibility of cable cover - please see at page 79

SPACE - TABLES

Design: Andersen Design Team

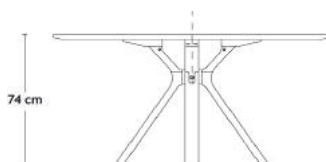
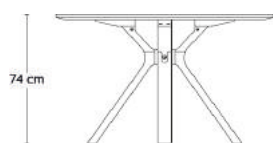
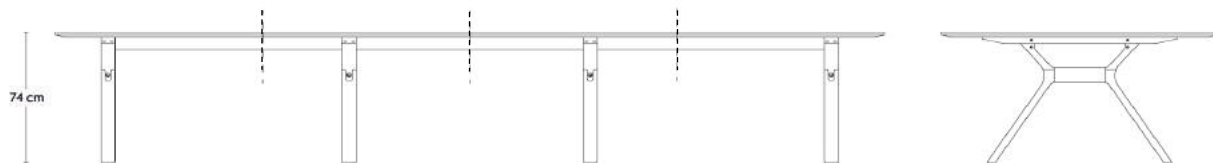
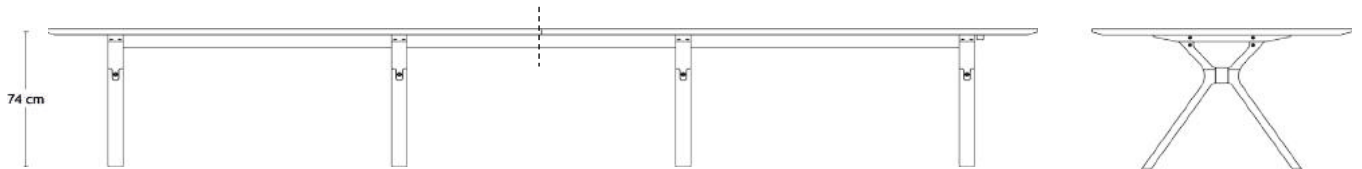
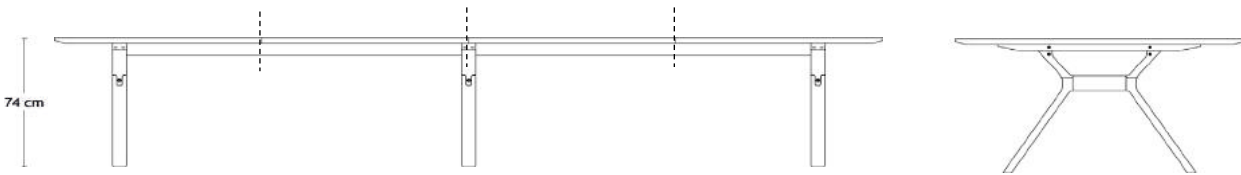
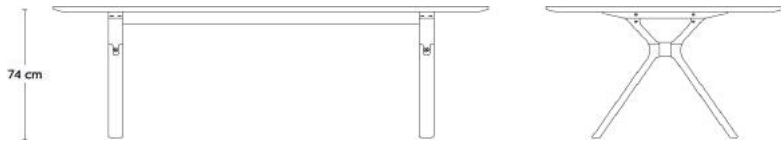

SPACE - HIGH TABLES

Design: Andersen Design Team

Table top	Oak veneer Lacquer	White Laminate (HPL)	Coloured Laminate (HPL)	Black Fenix Laminate*	Black Linoleum**
Edge	Edge in oak	Edge blackpainted***	Edge blackpainted***	Edge blackpainted***	Edge blackpainted***

Legs in oak - choose between: Whitepigmented matt lacquer / Clear matt lacquer / Black lacquer

Height 93 cm

0-70112-	160x70xH93 cm	2.855	2.100	2.250	2.555	2.555
0-70122-	160x80xH93 cm	2.855	2.100	2.250	2.555	2.555
0-70152-	220x70xH93 cm	3.005	2.250	2.405	2.705	2.705
0-70162-	220x80xH93 cm	3.005	2.250	2.405	2.705	2.705
0-70212-	275x70xH93 cm	3.155	2.405	2.555	2.855	2.855
0-70222-	275x80xH93 cm	3.155	2.405	2.555	2.855	2.855
0-71102-	Ø75xH93 cm	1.800	1.500	1.650	1.670	1.670
0-71402-	Ø90xH93 cm	1.950	1.650	1.800	1.820	1.820

Height 108 cm

0-70111-	160x70xH108 cm	2.855	2.100	2.250	2.555	2.555
0-70121-	160x80xH108 cm	2.855	2.100	2.250	2.555	2.555
0-70151-	220x70xH108 cm	3.005	2.250	2.405	2.705	2.705
0-70161-	220x80xH108 cm	3.005	2.250	2.405	2.705	2.705
0-70211-	275x70xH108 cm	3.155	2.405	2.555	2.855	2.855
0-70221-	275x80xH108 cm	3.155	2.405	2.555	2.855	2.855
0-71101-	Ø75xH108 cm	1.800	1.500	1.650	1.670	1.670
0-71401-	Ø90xH108 cm	1.950	1.650	1.800	1.820	1.820

Surcharge

* Additional fee for other Fenix laminate colours than black: 15%

** Additional fee for other linoleum colours than black: 15%

*** Additional fee for edge in oak or edge painted in colour as laminate: 10%

PRODUCT HIGHLIGHTS

- Possibility of cable cover - please see at page 79



SPACE - EXTENDABLE TABLES

Design: Andersen Design Team

	White laminate Alpino K1040	Fenix laminate Castoro Ottawa 0717	Fenix laminate Verde Comodoro 0750
Tabletop			
Edge	Edge blackpainted *	Edge painted as Fenix laminate *	Edge painted as Fenix laminate *

0-7903 95x220xH74 cm

Extension for 4 leaves

Legs: Oak (Whitepig. matt lacquer/Clear matt lacquer)	2.430	2.860	2.860
legs: Oak/Black lacquered)	2.430	2.860	2.860

	White laminate Alpino K1040	Fenix laminate Castoro Ottawa 0717	Fenix laminate Verde Comodoro 0750
Leaf 0-7913	380	540	540

Leaf

0-7913

	380	540	540
--	------------	------------	------------

Surcharge

* Additional fee for edge in oak: 10%

Tabletop



Alpino



Castoro Ottawa



Verde Comodoro

PRODUCT HIGHLIGHTS

- W 62 kg / CBM 0,4

Model 0-7903



95

220

TUBE - TABLES

Design: Randers+Radius

TABLE TOP - LAMINATE (HPL)



White
NCS S500-N



Light Grey
F7961

TABLE TOP - FENIX LAMINATE



Black (Nero Ingo)
0720



Grigio Londra
0718

TABLE TOP - LINOLEUM



Black (Nero)
4023

FRAME COLOURS



Black
RAL 9005



Chrome



TUBE - COLLECTION

Design: Randers+Radius

TUBE BASIC

Folding table with release arm and open aluminium beam.
Height 73 cm



Round corner

Square corner

TUBE FOLD

Folding table with release button and closed aluminium beam. Height 73 cm



Round corner

Square corner

TUBE WOOD

Folding table with release button and closed aluminium beam. Height 73 cm



TUBE STAY

Not foldable - fixed table with open aluminium beam. Height 73 cm



Round corner

Square corner

TUBE COUNTER

Folding table with release button and closed aluminium beam. Height 90 cm



Round corner

Square corner



Round corner.
Round tube profile



Square corner.
90° tube profile



Tube Wood
Black frame w/wooden legs



Tube Fold, Tube Counter & Tube Wood
Release button and closed aluminium beam



Tube Basic
Open aluminium beam w/release arm



Stacking buffers

TUBE - COLLECTION

Design: Randers+Radius

TABLETOP		FOLDING TABLES TUBE FOLD		FOLDING TABLES TUBE COUNTER		
		BLACK	CHROME	BLACK	CHROME	SATIN CHROME
LENGTH	WIDTH					
140	60	•	•	•	•	+
180	60	•	•	•	•	+
120	70	•	•			
140	70	•	•			
160	70	•	•			
180	70	•	•			
80	80	•	•			
120	80	•	•			
140	80	•	•			
160	80	•	•			
180	80	•	•			
180	90	•	•			
Ø110		•	•			
Ø120		•	•			

TABLETOP		FOLDING TABLES TUBE WOOD	
		WHITE TINTED LACQUERED OAK	BLACK LACQUERED OAK
LENGTH	WIDTH		
80	80	•	•
120	80	•	•
140	80	•	•
160	80	•	•
180	80	•	•
180	90		
Ø110		•	•
Ø120		•	•

TABLETOP		NON-FOLDING TABLES TUBE FOLD	
		BLACK	CHROME
LENGTH	WIDTH		
120	70	•	•
140	70	•	•
160	70	•	•
180	70	•	•
80	80	•	•
120	80	•	•
140	80	•	•
160	80	•	•
180	80	•	•
180	90		
Ø110		•	•
Ø120		•	•

- Standard

TUBE - WEIGHT OVERVIEW

Design: Randers+Radius

TABLETOP		FOLDING TABLES								NON FOLDING	
		TUBE BASIC		TUBE FOLD		TUBE WOOD	TUBE COUNTER		TUBE STAY		
		Round TBR	Square TBS	Round TFR	Square TFS	TW	Round TCR	Square TCS	Round TSR	Square TSS	
LENGTH	WIDTH										
140	60	22,5	23,5	22,7	23,6		23,7	24,7			
180	60	26,7	27,7	27,3	28,2		28,3	29,3			
120	70	22,6	23,5	22,5	23,5				20,8	21,7	
140	70	25,0	25,9	25,1	26,1				23,1	24,1	
160	70	27,4	28,3	27,7	28,6				25,5	26,5	
180	70	29,7	30,7	30,3	31,2				27,9	28,8	
80	80	19,3	20,2	18,9	19,8	18,74			17,8	18,7	
120	80	24,6	25,6	24,5	25,5	24,41			23,1	24,1	
140	80	27,3	28,2	27,4	28,4	27,28			25,8	26,7	
160	80	30,0	30,9	30,3	31,2	30,15			28,5	29,4	
180	80	32,6	33,6	33,2	34,1	33,03			31,1	32,1	
180	90	35,5	36,5	36,1	37,0						
	Ø110	23,8	24,7	23,4	24,3	23,27			22,3	23,2	
	Ø120	26,4	27,4	26,0	27,0	25,90			24,9	25,9	

The listed weights are based on a 19 mm top with HPL laminate / Fenix laminate and ABS edge. The weights are indicative.

Weights in kilograms to be added for other finishes:

- Linoleum with ABS edge, ca. 0,4 kg/ m²
- HPL laminate or Fenix laminate with plywood, ca. 0,5 kg/ m²
- Linoleum with plywood, ca: 0,9 kg/ m²

Light weight tops are available upon request, the weight reduction is approx. 5 kg / m²



TUBE BASIC - TABLES

Design: Randers+Radius

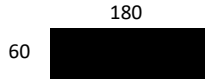
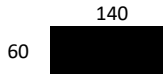

Tabletop	ABS edge			Plywood		
	HPL Laminate	Fenix Laminate	Linoleum*	HPL Laminate	Fenix Laminate	Linoleum*

TBR / TBS 6140 - 140 x 60 cm

Frame colour: Black / chrome

Round	1.044	1.194	1.233	Ask for price		
Square	1.136	1.288	1.325			

Chair hanger: No

TBR / TBS 6180 - 180 x 60 cm

Frame colour: Black / chrome

Round	1.161	1.395	1.378	Ask for price		
Square	1.255	1.487	1.470			

Chair hanger: No

*Please treat linoleum surfaces with care when stacking in order to avoid scratches and pressure marks. We recommend vertical storage in our transport trolley - table top against table top.

Other sizes and finishes are available, please contact our sales office.

Choice of other colours: Formica Colors and Forbo Linoleum + 10%

Frame colour



Black



Chrome

PRODUCT HIGHLIGHTS

- Folding table
- Passed: EN15372
- Open aluminium beam
- Press the release button and the legs fold, can be managed by just one person
- High stability - extraordinary quality
- The table comes with 2 integrated casters and 4 stacking buffers
- Top thickness: 20mm
- Height: 73cm
- Free space between the gables: width minus 12 cm



TUBE BASIC - TABLES

Design: Randers+Radius

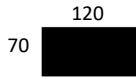

Tabletop	ABS edge			Plywood		
	HPL Laminate	Fenix Laminate	Linoleum*	HPL Laminate	Fenix Laminate	Linoleum*

TBR / TBS 7120 - 120 x 70 cm

Frame colour: Black / chrome

Round	1.025	1.200	1.214	Ask for price		
Square	1.118	1.294	1.308			

Chair hanger: No

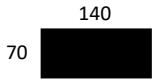

TBR / TBS 7140 - 140 x 70 cm

Frame colour: Black / chrome

Round	1.058	1.290	1.267	Ask for price		
Square	1.151	1.382	1.360			

Chair hanger: No

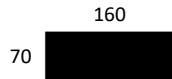

TBR / TBS 7160 - 160 x 70 cm

Frame colour: Black / chrome

Round	1.144	1.354	1.360	Ask for price		
Square	1.239	1.448	1.454			

Chair hanger: No

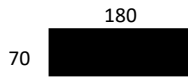

TBR / TBS 7180 - 180 x 70 cm

Frame colour: Black / chrome

Round	1.192	1.446	1.421	Ask for price		
Square	1.284	1.540	1.514			

Chair hanger: No

*Please treat linoleum surfaces with care when stacking in order to avoid scratches and pressure marks. We recommend vertical storage in our transport trolley - table top against table top.

Other sizes and finishes are available, please contact our sales office.

Choice of other colours: Formica Colors and Forbo Linoleum + 10%

Frame colour



Black



Chrome

PRODUCT HIGHLIGHTS

- Folding table
- Passed: EN15372
- Open aluminium beam
- Press the release button and the legs fold, can be managed by just one person
- High stability - extraordinary quality
- The table comes with 2 integrated casters and 4 stacking buffers
- Top thickness: 20mm
- Height: 73cm
- Free space between the gables: width minus 12 cm



TUBE BASIC - TABLES

Design: Randers+Radius

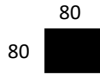

Tabletop	ABS edge			Plywood		
	HPL Laminate	Fenix Laminate	Linoleum*	HPL Laminate	Fenix Laminate	Linoleum*

TBR / TBS 8080 - 80 x 80 cm

Frame colour: Black / chrome

Round	900	1.036	1.064	Ask for price		
Square	995	1.130	1.159	Ask for price		

Chair hanger: Yes, 2 chairs (see overview on page 136)

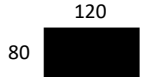

TBR / TBS 8120 - 120 x 80 cm

Frame colour: Black / chrome

Round	1.046	1.235	1.241	Ask for price		
Square	1.140	1.331	1.335	Ask for price		

Chair hanger: Yes, 4 chairs** (see overview on page 136)

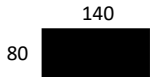

TBR / TBS 8140 - 140 x 80 cm

Frame colour: Black / chrome

Round	1.083	1.315	1.300	Ask for price		
Square	1.175	1.407	1.395	Ask for price		

Chair hanger: Yes, 4 chairs (see overview on page 136)

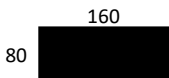

TBR / TBS 8160 - 160 x 80 cm

Frame colour: Black / chrome

Round	1.169	1.454	1.401	Ask for price		
Square	1.261	1.548	1.493	Ask for price		

Chair hanger: Yes, 4 chairs (see overview on page 136)

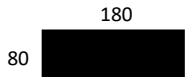

TBR / TBS 8180 - 180 x 80 cm

Frame colour: Black / chrome

Round	1.212	1.503	1.462	Ask for price		
Square	1.304	1.598	1.557	Ask for price		

Chair hanger: Yes, 6 chairs (see overview on page 136)

*Please treat linoleum surfaces with care when stacking in order to avoid scratches and pressure marks. We recommend vertical storage in our transport trolley - table top against table top.

**Not enough space for 2 Dry chairs side by side

Other sizes and finishes are available, please contact our sales office.

Choice of other colours: Formica Colors and Forbo Linoleum + 10%

Frame colour



Black



Chrome

PRODUCT HIGHLIGHTS

- Folding table
- Passed: EN15372
- Open aluminium beam
- Press the release button and the legs fold, can be managed by just one person
- Stacking height: only 7cm per table - also with chair hanger
- Available with chair hanger
- High stability - extraordinary quality
- The table comes with 2 integrated casters and 4 stacking buffers
- Top thickness: 20mm
- Height: 73cm
- Free space between the gables: width minus 12 cm



TUBE BASIC - TABLES

Design: Randers+Radius

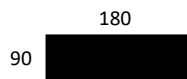

Tabletop	ABS edge			Plywood		
	HPL Laminate	Fenix Laminate	Linoleum*	HPL Laminate	Fenix Laminate	Linoleum*

TBR / TBS 9180 - 180 x 90 cm

Frame colour: Black / chrome

Round	1.280	1.624	1.573	Ask for price		
Square	1.372	1.717	1.667	Ask for price		

Chair hanger: Yes, 6 chairs (see overview on page 136)

TBR / TBS 0110 - Ø110

Frame colour: Black / chrome

Round	1.052	1.319	1.288	Ask for price		
Square	1.144	1.413	1.382	Ask for price		

Chair hanger: No

TBR / TBS 0120 - Ø120

Frame colour: Black / chrome

Round	1.095	1.325	1.337	Ask for price		
Square	1.187	1.419	1.431	Ask for price		

Chair hanger: No

*Please treat linoleum surfaces with care when stacking in order to avoid scratches and pressure marks. We recommend vertical storage in our transport trolley - table top against table top.

Other sizes and finishes are available, please contact our sales office.

Choice of other colours: Formica Colors and Forbo Linoleum + 10%

Frame colour



Black



Chrome

PRODUCT HIGHLIGHTS

- Folding table
- Passed: EN15372
- Open aluminium beam
- Press the release button and the legs fold, can be managed by just one person
- Stacking height: only 7cm per table - also with chair hanger
- Available with chair hanger
- High stability - extraordinary quality
- The table comes with 2 integrated casters and 4 stacking buffers
- Top thickness: 20mm
- Height: 73cm
- Free space between the gables: width minus 12 cm



TUBE FOLD - TABLES

Design: Randers+Radius

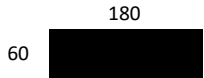
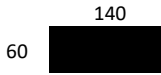

Tabletop	ABS edge			Plywood		
	HPL Laminate	Fenix Laminate	Linoleum*	HPL Laminate	Fenix Laminate	Linoleum*

TFR / TFS 6140 - 140 x 60 cm

Frame colour: Black / chrome

Round	1.077	1.212	1.247	Ask for price		
Square	1.171	1.306	1.341			

Chair hanger: No

TFR / TFS 6180 - 180 x 60 cm

Frame colour: Black / chrome

Round	1.196	1.401	1.386	Ask for price		
Square	1.290	1.495	1.481			

Chair hanger: No

*Please treat linoleum surfaces with care when stacking in order to avoid scratches and pressure marks. We recommend vertical storage in our transport trolley - table top against table top.

Other sizes and finishes are available, please contact our sales office.

Choice of other colours: Formica Colors and Forbo Linoleum + 10%

Frame colour



Black



Chrome

PRODUCT HIGHLIGHTS

- Folding table
- Passed: EN15372
- Closed aluminium beam
- Press the release button and the legs fold, can be managed by just one person
- Stacking height: only 7cm per table - also with chair hanger
- High stability - extraordinary quality
- The table comes with 2 integrated casters and 4 stacking buffers
- Top thickness: 20 mm
- Height: 73 cm
- Free space between the gables: width minus 12 cm



TUBE FOLD - TABLES

Design: Randers+Radius

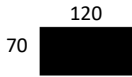

Tabletop	ABS edge			Plywood		
	HPL Laminate	Fenix Laminate	Linoleum*	HPL Laminate	Fenix Laminate	Linoleum*

TFR / TFS 7120 - 120 x 70 cm

Frame colour: Black / chrome

Round	1.056	1.216	1.228	Ask for price		
Square	1.151	1.310	1.325			

Chair hanger: No

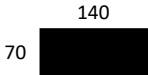

TFR / TFS 7140 - 140 x 70 cm

Frame colour: Black / chrome

Round	1.091	1.300	1.280	Ask for price		
Square	1.185	1.395	1.374			

Chair hanger: No



TFR / TFS 7160 - 160 x 70 cm

Frame colour: Black / chrome

Round	1.181	1.368	1.374	Ask for price		
Square	1.276	1.462	1.468			

Chair hanger: No

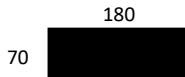

TFR / TFS 7180 - 180 x 70 cm

Frame colour: Black / chrome

Round	1.226	1.452	1.429	Ask for price		
Square	1.323	1.548	1.524			

Chair hanger: No

*Please treat linoleum surfaces with care when stacking in order to avoid scratches and pressure marks. We recommend vertical storage in our transport trolley - table top against table top.

Other sizes and finishes are available, please contact our sales office.

Choice of other colours: Formica Colors and Forbo Linoleum + 10%

Frame colour



Black



Chrome

PRODUCT HIGHLIGHTS

- Folding table
- Passed: EN15372
- Closed aluminium beam
- Press the release button and the legs fold, can be managed by just one person
- Stacking height: only 7cm per table - also with chair hanger
- High stability - extraordinary quality
- The table comes with 2 integrated casters and 4 stacking buffers
- Top thickness: 20 mm
- Height: 73 cm
- Free space between the gables: width minus 12 cm



TUBE FOLD - TABLES

Design: Randers+Radius

Tabletop	ABS edge			Plywood		
	HPL Laminate	Fenix Laminate	Linoleum*	HPL Laminate	Fenix Laminate	Linoleum*

TFR / TFS 8080 - 80 x 80 cm

Frame colour: Black / chrome

Round	929	1.060	1.087	Ask for price		
Square	1.023	1.155	1.183	Ask for price		

Chair hanger: Yes, 2 chairs (see overview on page 136)

TFR / TFS 8120 - 120 x 80 cm

Frame colour: Black / chrome

Round	1.079	1.253	1.257	Ask for price		
Square	1.173	1.347	1.352	Ask for price		

Chair hanger: Yes, 4 chairs** (see overview on page 136)

TFR / TFS 8140 - 140 x 80 cm

Frame colour: Black / chrome

Round	1.116	1.325	1.313	Ask for price		
Square	1.210	1.419	1.407	Ask for price		

Chair hanger: Yes, 4 chairs (see overview on page 136)

TFR / TFS 8160 - 160 x 80 cm

Frame colour: Black / chrome

Round	1.204	1.460	1.411	Ask for price		
Square	1.300	1.555	1.507	Ask for price		

Chair hanger: Yes, 4 chairs (see overview on page 136)

TFR / TFS 8180 - 180 x 80 cm

Frame colour: Black / chrome

Round	1.249	1.507	1.470	Ask for price		
Square	1.343	1.602	1.567	Ask for price		

Chair hanger: Yes, 6 chairs (see overview on page 136)

*Please treat linoleum surfaces with care when stacking in order to avoid scratches and pressure marks. We recommend vertical storage in our transport trolley - table top against table top.

**Not enough space for 2 Dry chairs side by side

Other sizes and finishes are available, please contact our sales office.

Choice of other colours: Formica Colors and Forbo Linoleum + 10%

Frame colour



Black



Chrome

PRODUCT HIGHLIGHTS

- Folding table
- Passed: EN15372
- Closed aluminium beam
- Press the release button and the legs fold, can be managed by just one person
- Stacking height: only 7cm per table - also with chair hanger
- Available with chair hanger
- High stability - extraordinary quality
- The table comes with 2 integrated casters and 4 stacking buffers
- Top thickness: 20 mm
- Height: 73 cm
- Free space between the gables: width minus 12 cm



TUBE FOLD - TABLES

Design: Randers+Radius

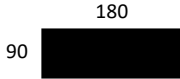

Tabletop	ABS edge			Plywood		
	HPL Laminate	Fenix Laminate	Linoleum*	HPL Laminate	Fenix Laminate	Linoleum*

TFR / TFS 9180 - 180 x 90 cm

Frame colour: Black / chrome

Round	1.319	1.628	1.581	Ask for price		
Square	1.415	1.723	1.676	Ask for price		

Chair hanger: Yes, 6 chairs (see overview on page 136)

TFR / TFS 0110 - Ø110

Frame colour: Black / chrome

Round	1.077	1.335	1.304	Ask for price		
Square	1.173	1.431	1.401	Ask for price		

Chair hanger: No

TFR / TFS 0120 - Ø120

Frame colour: Black / chrome

Round	1.128	1.354	1.366	Ask for price		
Square	1.224	1.448	1.460	Ask for price		

Chair hanger: No

*Please treat linoleum surfaces with care when stacking in order to avoid scratches and pressure marks. We recommend vertical storage in our transport trolley - table top against table top.

Other sizes and finishes are available, please contact our sales office.

Choice of other colours: Formica Colors and Forbo Linoleum + 10%

Frame colour



Black



Chrome

PRODUCT HIGHLIGHTS

- Folding table
- Passed: EN15372
- Closed aluminium beam
- Press the release button and the legs fold, can be managed by just one person
- Stacking height: only 7cm per table - also with chair hanger
- Available with chair hanger
- High stability - extraordinary quality
- The table comes with 2 integrated casters and 4 stacking buffers
- Top thickness: 20 mm
- Height: 73 cm
- Free space between the gables: width minus 12 cm



TUBE WOOD - TABLES

Design: Randers+Radius

Tabletop	ABS edge			Plywood		
	HPL Laminate	Fenix Laminate	Linoleum*	HPL Laminate	Fenix Laminate	Linoleum*

TW8080 - 80 x 80 cm

Frame colour: Black top frame w. white tinted / black lacquered oak legs

1.091 1.222 1.251

Ask for price

Chair hanger: Yes, 2 chairs (see overview on page 136)

TW8120 - 120 x 80 cm

Frame colour: Black top frame w. white tinted / black lacquered oak legs

1.241 1.415 1.419

Ask for price

Chair hanger: Yes, 4 chairs** (see overview on page 136)

TW8140 - 140 x 80 cm

Frame colour: Black top frame w. white tinted / black lacquered oak legs

1.278 1.487 1.475

Ask for price

Chair hanger: Yes, 4 chairs (see overview on page 136)

TW8160 - 160 x 80 cm

Frame colour: Black top frame w. white tinted / black lacquered oak legs

1.368 1.622 1.575

Ask for price

Chair hanger: Yes, 4 chairs (see overview on page 136)

TW8180 - 180 x 80 cm

Frame colour: Black top frame w. white tinted / black lacquered oak legs

1.411 1.669 1.635

Ask for price

Chair hanger: Yes, 6 chairs (see overview on page 136)

*Please treat linoleum surfaces with care when stacking in order to avoid scratches and pressure marks. We recommend vertical storage in our transport trolley - table top against table top.

**Not enough space for 2 Dry chairs side by side

Other sizes and finishes are available, please contact our sales office.

Choice of other colours: Formica Colors and Forbo Linoleum + 10%

Frame colour



PRODUCT HIGHLIGHTS

- Folding table
- Passed: EN15372
- Closed aluminium beam
- Press the release button and the legs fold, can be managed by just one person
- Stacking height: only 7cm per table - also with chair hanger
- Available with chair hanger
- High stability - extraordinary quality
- The table comes with 4 stacking buffers
- Top thickness: 20 mm
- Solid wood legs
- Height: 73 cm
- Free space between the gables: width minus 12 cm



TUBE WOOD - TABLES

Design: Randers+Radius

Tabletop	ABS edge			Plywood		
	HPL Laminate	Fenix Laminate	Linoleum*	HPL Laminate	Fenix Laminate	Linoleum*

TW0110 - Ø110

Frame colour: Black top frame w. white tinted / black lacquered oak legs

1.241 1.497 1.468 [Ask for price](#)

Chair hanger: No

TW0120 - Ø120

Frame colour: Black top frame w. white tinted / black lacquered oak legs

1.290 1.516 1.528 [Ask for price](#)

Chair hanger: No

*Please treat linoleum surfaces with care when stacking in order to avoid scratches and pressure marks. We recommend vertical storage in our transport trolley - table top against table top.

**Not enough space for 2 Dry chairs side by side

Other sizes and finishes are available, please contact our sales office.

Choice of other colours: Formica Colors and Forbo Linoleum + 10%

Frame colour



Black



Oak

White tinted

PRODUCT HIGHLIGHTS

- Folding table
- Passed: EN15372
- Closed aluminium beam
- Press the release button and the legs fold, can be managed by just one person
- Stacking height: only 7cm per table - also with chair hanger
- High stability - extraordinary quality
- The table comes with 4 stacking buffers
- Top thickness: 20 mm
- Solid wood legs
- Height: 73 cm
- Free space between the gables: width minus 12 cm



TUBE COUNTER - TABLES

Design: Randers+Radius

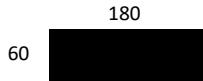
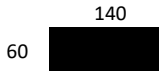

Tabletop	ABS edge			Plywood		
	HPL Laminate	Fenix Laminate	Linoleum*	HPL Laminate	Fenix Laminate	Linoleum*

TCR / TCS 6140 - 140 x 60 cm

Frame colour: Black / chrome

Round	1.136	1.274	1.306	Ask for price		
Square	1.233	1.368	1.403			

Chair hanger: No

TCR / TCS 6180 - 180 x 60 cm

Frame colour: Black / chrome

Round	1.257	1.460	1.448	Ask for price		
Square	1.352	1.557	1.542			

Chair hanger: No

*Please treat linoleum surfaces with care when stacking in order to avoid scratches and pressure marks. We recommend vertical storage in our transport trolley - table top against table top.

Other sizes and finishes are available, please contact our sales office.

Choice of other colours: Formica Colors and Forbo Linoleum + 10%

Frame colour



Black



Chrome

PRODUCT HIGHLIGHTS

- Folding table
- Passed: EN15372
- Closed aluminium beam
- Press the release button and the legs fold, can be managed by just one person
- Stacking height: only 7cm per table - also with chair hanger
- High stability - extraordinary quality
- The table comes with 4 stacking buffers
- Top thickness: 20 mm
- Height: 90 cm



TUBE STAY - TABLES

Design: Randers+Radius

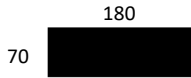
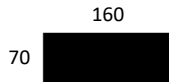
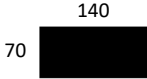
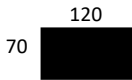

Tabletop	ABS edge			Plywood		
	HPL Laminate	Fenix Laminate	Linoleum*	HPL Laminate	Fenix Laminate	Linoleum*

TSR / TSS 7120 - 120 x 70 cm

Frame colour: Black / chrome

Round	837	997	1.007	Ask for price		
Square	931	1.091	1.103	Ask for price		

Chair hanger: No

TSR / TSS 7140 - 140 x 70 cm

Frame colour: Black / chrome

Round	853	1.064	1.044	Ask for price		
Square	950	1.161	1.138	Ask for price		

Chair hanger: No

TSR / TSS 7160 - 160 x 70 cm

Frame colour: Black / chrome

Round	921	1.105	1.112	Ask for price		
Square	1.015	1.200	1.208	Ask for price		

Chair hanger: No

TSR / TSS 7180 - 180 x 70 cm

Frame colour: Black / chrome

Round	945	1.171	1.146	Ask for price		
Square	1.040	1.267	1.243	Ask for price		

Chair hanger: No

*Please treat linoleum surfaces with care when stacking in order to avoid scratches and pressure marks. We recommend vertical storage in our transport trolley - table top against table top.

Other sizes and finishes are available, please contact our sales office.

Choice of other colours: Formica Colors and Forbo Linoleum + 10%

Frame colour



Black



Chrome

PRODUCT HIGHLIGHTS

- Not foldable - fixed table
- Passed: EN15372
- Open aluminium beam
- High stability - extraordinary quality
- Top thickness: 20 mm
- Height: 73 cm
- Free space between the gables: width minus 12 cm



TUBE STAY - TABLES

Design: Randers+Radius

Tabletop	ABS edge			Plywood		
	HPL Laminate	Fenix Laminate	Linoleum*	HPL Laminate	Fenix Laminate	Linoleum*

TSR / TSS 8080 - 80 x 80 cm

Frame colour: Black / chrome



Round	792	921	950	Ask for price		
Square	886	1.017	1.046	Ask for price		

Chair hanger: Yes, 2 chairs (see overview on page 136)

TSR / TSS 8120 - 120 x 80 cm

Frame colour: Black / chrome

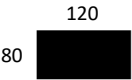

Round	859	1.034	1.038	Ask for price		
Square	954	1.128	1.132	Ask for price		

Chair hanger: Yes, 4 chairs** (see overview on page 136)

TSR / TSS 8140 - 140 x 80 cm

Frame colour: Black / chrome



Round	880	1.087	1.077	Ask for price		
Square	974	1.183	1.173	Ask for price		

Chair hanger: Yes, 4 chairs (see overview on page 136)

TSR / TSS 8160 - 160 x 80 cm

Frame colour: Black / chrome

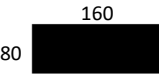

Round	943	1.198	1.151	Ask for price		
Square	1.038	1.294	1.245	Ask for price		

Chair hanger: Yes, 4 chairs (see overview on page 136)

TSR / TSS 8180 - 180 x 80 cm

Frame colour: Black / chrome

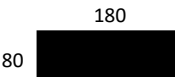

Round	966	1.226	1.189	Ask for price		
Square	1.062	1.321	1.286	Ask for price		

Chair hanger: Yes, 6 chairs (see overview on page 136)

*Please treat linoleum surfaces with care when stacking in order to avoid scratches and pressure marks. We recommend vertical storage in our transport trolley - table top against table top.

**Not enough space for 2 Dry chairs side by side

Other sizes and finishes are available, please contact our sales office.

Choice of other colours: Formica Colors and Forbo Linoleum + 10%

Frame colour

 Black
  Chrome

PRODUCT HIGHLIGHTS

- Not foldable - fixed table
- Passed: EN15372
- Open aluminium beam
- Available with chair hanger
- High stability - extraordinary quality
- Top thickness: 20 mm
- Height: 73 cm
- Free space between the gables: width minus 12 cm



TUBE STAY - TABLES

Design: Randers+Radius

Tabletop	ABS edge			Plywood		
	HPL Laminate	Fenix Laminate	Linoleum*	HPL Laminate	Fenix Laminate	Linoleum*

TSR / TSS 0110 - Ø110

Frame colour: Black / chrome

Round	939	1.198	1.167	Ask for price		
Square	1.034	1.292	1.261	Ask for price		

Chair hanger: No

TSR / TSS 0120 - Ø120

Frame colour: Black / chrome

Round	991	1.214	1.228	Ask for price		
Square	1.085	1.310	1.325	Ask for price		

Chair hanger: No

*Please treat linoleum surfaces with care when stacking in order to avoid scratches and pressure marks. We recommend vertical storage in our transport trolley - table top against table top.

Other sizes and finishes are available, please contact our sales office.

Choice of other colours: Formica Colors and Forbo Linoleum + 10%

Frame colour



Black



Chrome

PRODUCT HIGHLIGHTS

- Not foldable - fixed table
- Passed: EN15372
- Open aluminium beam
- High stability - extraordinary quality
- Top thickness: 20 mm
- Height: 73 cm
- Free space between the gables: width minus 12 cm

TUBE - MODESTY PANEL/END PANEL

Design: Randers+Radius

Tabletop Black Fenix laminate

Edge ABS Edge

TFRONT30080

Tube modesty panel - 80 x 30 cm

363

TFRONT30120

Tube modesty panel - 120 x 30 cm

439

TFRONT30140

Tube modesty panel - 1400 x 30 cm

459

TFRONT30160

Tube modesty panel - 1600 x 30 cm

478

TFRONT30180

Tube modesty panel - 180 x 30 cm

517



TGAVL8064

End panel - 64 x 80 cm

535



TUBE - TRANSPORT TROLLEY

Design: Randers+Radius

TU7401

Transport and storage trolley for 10 tables - 125 x 45 x 126 cm

1.251



T1 - SERIES

Design: byKATO

TABLE TOP - LAMINATE (HPL)



White (Alpino)
K1040



Kashmir
F0187



Cafe
F0903



Terril
F2297



Diamond Black
F2253



Ocean Grey
F7853



Pumice
F7858



Silver
F2791



Iron
F7902



Pale Olive
F3007



Artic Blue
F5493



Lead
F7924



Mouse
F7928

TABLE TOP - FENIX LAMINATE



Black (Nero Ingo)
0720



Bianco Male
0029



Beige Luxor
0719



Beige Arizona
0748



Castoro Ottawa
0717



Cacao Orinoco
0749



Grigio Efeso
0725



Grigio Antrim
0752



Grigio Londra
0718



Grigio Bromo
0724



Rosso Jaipur
0751



Verde Comodoro
0750



Blu Fes
0754

TABLE TOP - LINOLEUM



Black (Nero)
4023



Ash
4132



Burgundy
4154



Iron
4178



Mauve
4172



Mushrom
4176



Olive
4184



Orange Blast
4186



Pebble
4175



Pearl
4157



Pewter
4155



Pistachio
4183



Powder
4185



Salsa
4164



Smokey Blue
4179



Aquavert
4180



Spring Green
4182



Vapour
4177



Charcoal
4166



Conifer
4174



Midnight Blue
4181

LEGS / SUPPORTING FRAME



Oak
Whitepig, matt lacquer



Oak
Clear matt lacquer



Oak
Black lacquer



Walnut
Natural oil



T1 - TABLES

Design: byKATO

Table top	White Laminate (HPL)	Coloured Laminate (HPL)	Black Fenix Laminate*	Black Linoleum**
Edge	Edge blackpainted***	Edge blackpainted***	Edge blackpainted***	Edge blackpainted***
2-3001- 160x88xH72,5 cm				
Legs: Oak lacquerd ****	1.860	2.000	2.145	2.145
Legs: Walnut/Oil	2.145	2.290	2.430	2.430
2-3003- 180x95xH72,5 cm				
Legs: Oak lacquerd ****	2.000	2.145	2.290	2.290
Legs: Walnut/Oil	2.290	2.430	2.575	2.575
2-3005- 220x95xH72,5 cm				
Legs: Oak lacquerd ****	2.145	2.290	2.430	2.430
Legs: Walnut/Oil	2.430	2.575	2.720	2.720
2-3053- 240x110xH72,5 cm				
Legs: Oak lacquerd ****	2.290	2.430	2.575	2.575
Legs: Walnut/Oil	2.575	2.720	2.860	2.860
2-3058- 295x110xH72,5 cm				
Legs: Oak lacquerd ****	2.720	2.860	3.005	3.005
Legs: Walnut/Oil	3.005	3.150	3.290	3.290

88

95

95

110

110

Surcharge

* Additional fee for other Fenix laminate colours than black: 15%

** Additional fee for other linoleum colours than black: 15%

*** Additional fee for edge in oak or edge painted in colour as laminate: 10%

**** Choose between: Whitepigmented matt lacquer / Clear matt lacquer / Black lacquer

PRODUCT HIGHLIGHTS

- Possibility of cable cover - please see at page 79

- Model 2-3001: W 46 kg / CBM 0,27

- Model 2-3003: W 50 kg / CBM 0,30

- Model 2-3005: W 60 kg / CBM 0,34

- Model 2-3053: W 72 kg / CBM 0,45

- Model 2-3058: W 88 kg / CBM 0,45

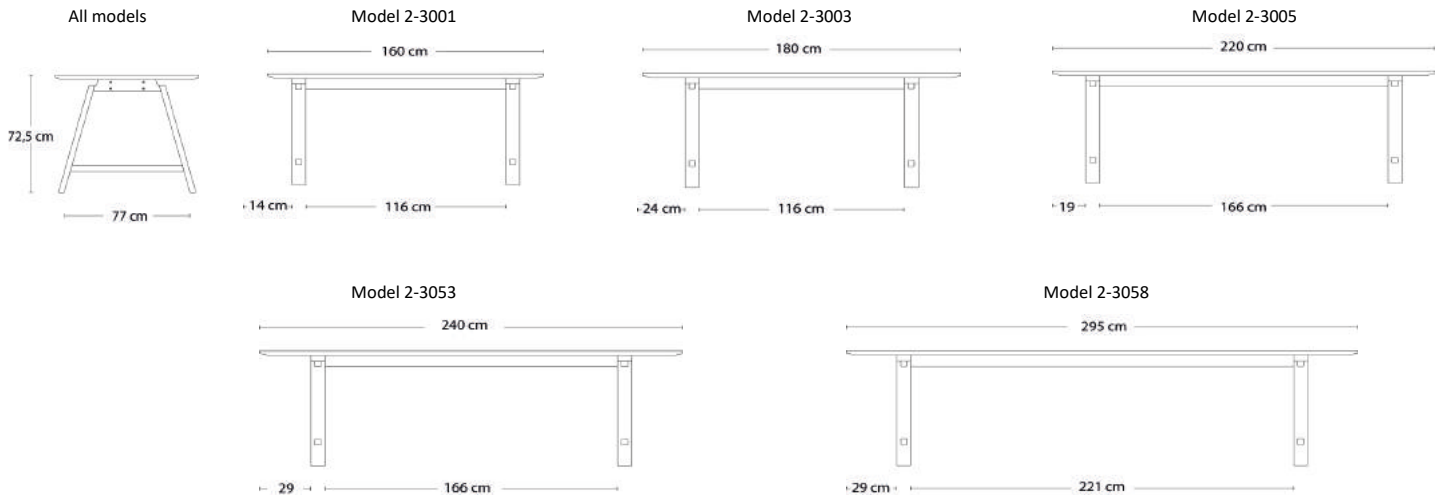

T1 - TABLES - WIDE MODEL

Design: byKATO

Table top		White Laminate (HPL)	Coloured Laminate (HPL)	Black Fenix Laminate*	Black Linoleum**
Kant		Edge blackpainted***	Edge blackpainted***	Edge blackpainted***	Edge blackpainted***
Width 120 cm Legs in oak - choose between: Whitepigmented matt lacquer / Clear matt lacquer / Black lacquer					
2-3105-	220x120xH72,5 cm	2.310	2.475	2.645	2.645
2-3107-	240x120xH72,5 cm	2.475	2.645	2.810	2.810
2-3109-	295x120xH72,5 cm	2.840	2.995	3.155	3.155
2-3113-	360x120xH72,5 cm	4.040	4.250	4.690	4.690
	2 table tops / 3 legs				
2-3117-	420x120xH72,5 cm	4.595	4.805	5.410	5.410
	2 table tops / 3 legs				
2-3121-	600x120xH72,5 cm	6.615	6.840	7.760	7.760
	3 table tops / 4 legs				
2-3125-	800x120xH72,5 cm	9.195	9.435	10.640	10.640
	4 table tops / 6 legs				
Width 140 cm Legs in oak - choose between: Whitepigmented matt lacquer / Clear matt lacquer / Black lacquer					
2-3205-	220x140xH72,5 cm	2.755	2.955	3.245	3.245
	2 table tops / 2 legs				
2-3207-	240x140xH72,5 cm	2.845	3.045	3.335	3.335
	2 table tops / 2 legs				
2-3209-	295x140xH72,5 cm	3.675	3.880	4.325	4.325
	3 table tops / 2 legs				
2-3213-	360x140xH72,5 cm	4.410	4.620	5.050	5.050
	3 table tops / 3 legs				
2-3217-	420x140xH72,5 cm	5.330	5.545	5.950	5.950
	4 table tops / 3 legs				
2-3221-	600x140xH72,5 cm	6.985	7.210	7.940	7.940
	5 table tops / 4 legs				
2-3225-	800x140xH72,5 cm	9.560	9.805	11.100	11.100
	7 table tops / 6 legs				
Width 160 cm Legs in oak - choose between: Whitepigmented matt lacquer / Clear matt lacquer / Black lacquer					
2-3305-	220x160xH72,5 cm	3.120	3.415	3.605	3.605
	2 table tops / 2 legs				
2-3307-	240x160xH72,5 cm	3.215	3.605	3.875	3.875
	2 table tops / 2 legs				
2-3309-	295x160xH72,5 cm	4.225	4.435	4.690	4.690
	3 table tops / 2 legs				
2-3313-	360x160xH72,5 cm	4.960	5.175	5.410	5.410
	3 table tops / 3 legs				
2-3317-	420x160xH72,5 cm	5.880	6.100	6.315	6.315
	4 table tops / 3 legs				
2-3321-	600x160xH72,5 cm	7.720	7.950	8.300	8.300
	5 table tops / 4 legs				
2-3325-	800x160xH72,5 cm	10.665	11.100	11.845	11.845
	7 table tops / 6 legs				

Surcharge

* Additional fee for other Fenix laminate colours than black: 15%

** Additional fee for other linoleum colours than black: 15%

*** Additional fee for edge in oak or edge painted in colour as laminate: 10%

PRODUCT HIGHLIGHTS

- Possibility of cable cover - please see at page 79



HT1 - HIGH TABLE

Design: byKATO

Tabletop	White Laminate (HPL)	Coloured Laminate (HPL)	Black Fenix Laminate*	Black Linoleum**
Edge	Edge blackpainted***	Edge blackpainted***	Edge blackpainted***	Edge blackpainted***

Height 93 cm Legs in oak - choose between: Whitepigmented matt lacquer / Clear matt lacquer / Black lacquer

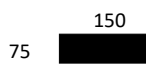

2-30202- 150x75xH93 cm

Legs: Oak/Lacquer **1.860** **2.000** **2.145** **2.145**

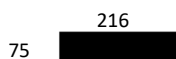

2-30252- 216x75xH93 cm

Legs: Oak/Lacquer **2.145** **2.290** **2.430** **2.430**

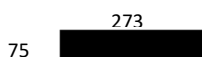

2-30272- 273x75x93 cm

Legs: Oak/Lacquer **2.430** **2.575** **2.720** **2.720**

Height 108 cm Legs in oak - choose between: Whitepigmented matt lacquer / Clear matt lacquer / Black lacquer



2-30201- 150x75x108 cm

Legs: Oak/Lacquer **1.860** **2.000** **2.145** **2.145**

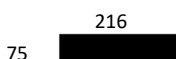

2-30251- 216x75x108 cm

Legs: Oak/Lacquer **2.145** **2.290** **2.430** **2.430**

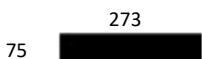

2-30271- 273x75x108 cm

Legs: Oak/Lacquer **2.430** **2.575** **2.720** **2.720**

Surcharge

- * Additional fee for other Fenix laminate colours than black: 15%
- ** Additional fee for other linoleum colours than black: 15%
- *** Additional fee for edge in oak or edge painted in colour as laminate: 10%

PRODUCT HIGHLIGHTS

- The footrest is covered in a stainless steel cap.
- Model 2-3020: W 40 kg / CBM 0,28
- Model 2-3025: W 60 kg / CBM 0,40
- Model 2-3027: W 75 kg / CBM 0,50

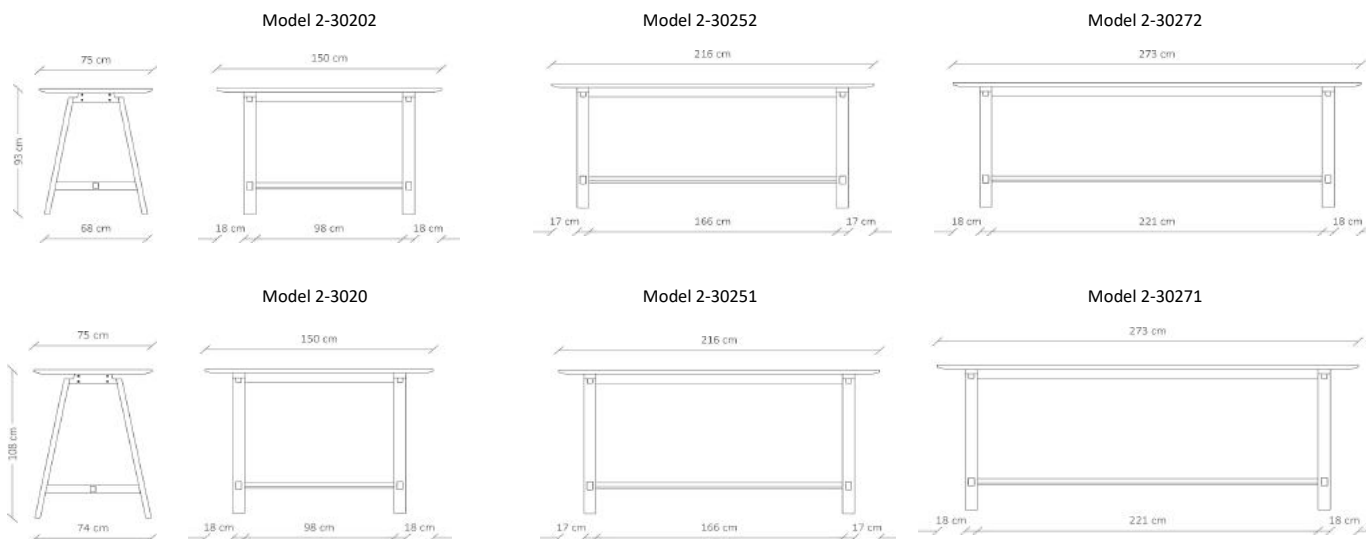

HT1 - HIGH TABLE - WIDE MODEL

Design: byKATO

Tabletop	White Laminate (HPL)	Coloured Laminate (HPL)	Black Fenix Laminate*	Black Linoleum**
Kant	Edge blackpainted***	Edge blackpainted***	Edge blackpainted***	Edge blackpainted***
Height 93 cm Legs in oak - choose between: Whitepigmented matt lacquer / Clear matt lacquer / Black lacquer				
2-31312- 216x100xH93 cm	2.405	2.555	2.705	2.705
2-31332- 240x100xH93 cm	2.475	2.600	2.975	2.975
2-31352- 273x100xH93 cm	2.855	3.005	3.155	3.155
2-31372- 360x100xH93 cm	2 table tops / 3 legs	3.965	4.165	4.380
2-31392- 480x100xH93 cm	2 table tops / 3 legs	4.465	4.685	5.080
2-31412- 216x120xH93 cm	2.855	3.005	3.155	3.155
2-31432- 240x120xH93 cm	3.140	3.295	3.680	3.680
2-31452- 273x120xH93 cm	3.530	3.680	3.830	3.830
2-31472- 360x120xH93 cm	2 table tops / 3 legs	4.630	4.860	5.430
2-31492- 480x120xH93 cm	2 table tops / 3 legs	5.620	5.900	6.485
Height 108 cm Legs in oak - choose between: Whitepigmented matt lacquer / Clear matt lacquer / Black lacquer				
2-31311- 216x100xH108 cm	2.405	2.555	2.705	2.705
2-31331- 240x100xH108 cm	2.475	2.600	2.975	2.975
2-31351- 273x100xH108 cm	2.855	3.005	3.155	3.155
2-31371- 360x100xH108 cm	2 table tops / 3 legs	3.965	4.165	4.380
2-31391- 480x100xH108 cm	2 table tops / 3 legs	4.465	4.685	5.080
2-31411- 216x120xH108 cm	2.855	3.005	3.155	3.155
2-31431- 240x120xH108 cm	3.140	3.295	3.680	3.680
2-31451- 273x120xH108 cm	3.530	3.680	3.830	3.830
2-31471- 360x120xH108 cm	2 table tops / 3 legs	4.630	4.860	5.430
2-31491- 480x120xH108 cm	2 table tops / 3 legs	5.620	5.900	6.485

Surcharge

* Additional fee for other Fenix laminate colours than black: 15%

** Additional fee for other linoleum colours than black: 15%

*** Additional fee for edge in oak or edge painted in colour as laminate: 10%

PRODUCT HIGHLIGHTS

- Possibility of cable cover - please see at page 79

T1 - EXTENDABLE TABLE

Design: byKATO



Tabletop	White Laminate (HPL)	Coloured Laminate (HPL)	Black Fenix Laminate*	Black Linoleum**
Edge	Edge blackpainted	Edge blackpainted	Edge blackpainted	Edge blackpainted

2-3006A 88x160xH72,5 cm

Extension for 3 leaves

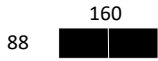

Legs: Oak lacquerd ***	2.145	2.430	2.575	2.430
Legs: Walnut/Oil	2.430	2.720	2.860	2.720

2-3008A 95x180xH72,5 cm

Extension for 3 leaves



Legs: Oak lacquerd ***	2.290	2.575	2.720	2.575
Legs: Walnut/Oil	2.575	2.860	3.005	2.860

2-3010A 95x220xH72,5 cm

Extension for 4 leaves

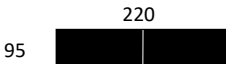

Legs: Oak lacquerd ***	2.430	2.720	2.860	2.720
Legs: Walnut/Oil	2.720	3.005	3.150	3.005

	Black Lacquer	White Laminate (HPL)	Coloured Laminate (HPL)	Black Fenix Laminate	Black Linoleum
Leaf					
2-3017A 50x88 cm	290	355	495	525	495
2-3015A 50x95 cm	290	355	495	525	495

* Note: The T1 extendable table with linoleum is only available with leaves with linoleum

** The edge of the tabletop og leaves is always blacklacquered

*** Choose between: Whitepigmented matt lacquer / Clear matt lacquer / Black lacquer

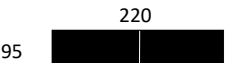

Table top and legs in solid oak

Oak Soap
Oak Oil *

2-3010M 95x220xH72,5 cm

Extension for 4 leaves



3.720
3.865

	Antracite Grey Lacquered	Oak Soap	Oak Oil *
Leaf			
2-3015M20 50x95 cm	315		
2-3015MA 50x95 cm		710	785

* Oak/Oil - Choose between: White oil - Natural oil

PRODUCT HIGHLIGHTS

- Model 2-3006: W 58 kg / CBM 0,30
- Model 2-3008: W 62 kg / CBM 0,30
- Model 2-3010: W 73 kg / CBM 0,34
- Model 2-3010: W 73 kg / CBM 0,40

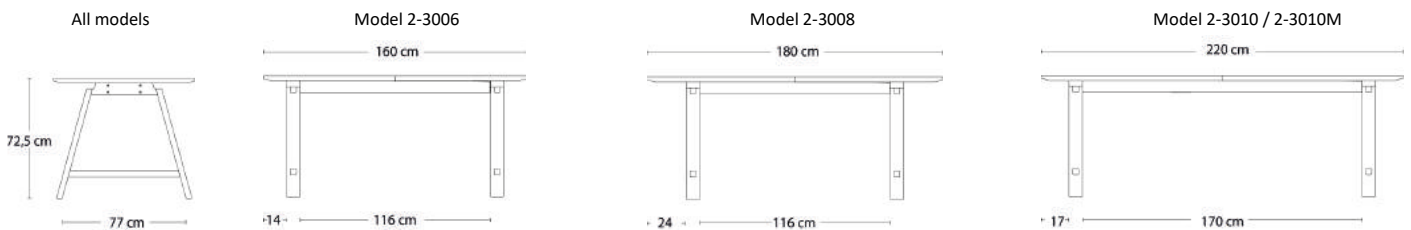



B2 - BENCH

Design: Andersen Design Team

Oak
Whitepig. matt lacquer

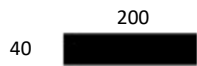

0-7320M0213 200x40xH45 cm

Legs: Oak/Whitepigmented matt lacquer

1.355

PRODUCT HIGHLIGHTS

- W 25 kg / CBM 0,1

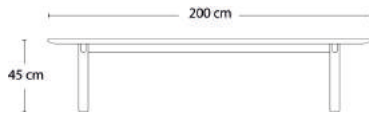

T3 - EXTENDABLE TABLE

Design: byKATO

TABLE TOP - LAMINATE (HPL)



White (Alpino)
K1040



Kashmir
F0187



Cafe
F0903



Terril
F2297



Diamond Black
F2253



Ocean Grey
F7853



Pumice
F7858



Silver
F2791



Iron
F7902



Pale Olive
F3007



Artic Blue
F5493



Lead
F7924



Mouse
F7928

TABLE TOP - FENIX LAMINATE



Black (Nero Ingo)
0720

LEGS / SUPPORTING FRAME



Oak
White oil



Oak
Natural oil



Oak
Soap



Oak
Black lacquer



T3 - EXTENDABLE TABLE

Design: byKATO

Tabletop	White Laminate (HPL)	Coloured Laminate (HPL)	Black Fenix Laminate
Edge	Underglued wooden edge in oak	Underglued wooden edge in oak	Underglued wooden edge in oak

2-4005A 95x200xH74 cm

Incl. synchronous extension

Integrated leaf 100x95 cm

Oak/Soap	4.150	4.295	4.440
Oak/Oil (Whiteoil/Natural oil)	4.150	4.295	4.440
Oak/Black lacquered)	4.150	4.295	4.440

PRODUCT HIGHLIGHTS

- W 75 kg / CBM 0,25
- Functional synchronised extension system that makes handling the leaf inserts especially easy

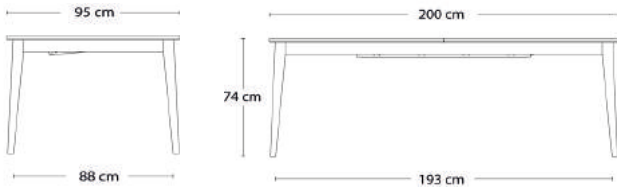

T7 - EXTENDABLE TABLE

Design: Ditlev Karsten

TABLE TOP - LAMINATE (HPL)



White (full coloured)
001R

TABLE TOP - FENIX LAMINATE



Black (Nero Ingo)
0720

LEGS / SUPPORTING FRAME



Oak
White oil



Oak
Natural oil



Oak
Soap



Oak
Black lacquer





T7 - EXTENDABLE TABLE

Design: Ditlev Karsten

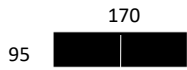

Tabletop	Solid white Laminate	Black Fenix Laminate
Edge	Edge whitepainted	Black lacquered edge

2-5702 95x170xH72,5 cm

Extension for 3 leaves

Oak/Soap	3.435	3.720
Oak/Oil (Whiteoil/Natural oil)	3.435	3.720
Oak/Black lacquered	3.435	3.720



2-5700 95x220xH72,5 cm

Extension for 4 leaves

Oak/Soap	3.580	3.865
Oak/Oil (Whiteoil/Natural oil)	3.580	3.865
Oak/Black lacquered	3.580	3.865

	Solid white Laminate	Black Fenix Laminate	White Lacquered
--	----------------------	----------------------	-----------------

Leaf

2-5710N 50x95 cm	495	540	
2-5715N 50x95 cm			325



Table top and legs in solid oak

Oak Soap	Oak Oil *
----------	-----------

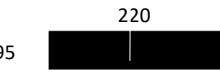

2-5800 95x220xH72,5 cm

Extension for 4 leaves

Oak	4.010	4.150
-----	--------------	--------------

	Anthracite grey lacquered	Oak Soap	Oak Oil *
--	---------------------------	----------	-----------

Leaf

2-5809M20 50x95 cm	325		
2-5812MA 50x95 cm		710	785

* Oak/Oil - Choose between: White oil - Natural oil

PRODUCT HIGHLIGHTS

- Model 2-5702: W 68 kg / CBM 0,27
- Model 2-5700 / 2-5800: W 78 kg / CBM 0,35

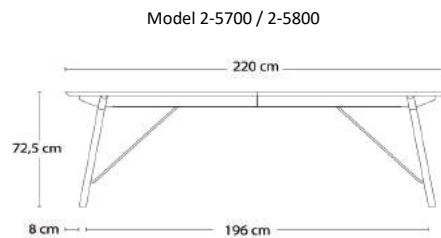
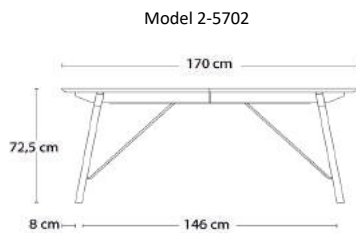

T8 - TABLES

Design: Weitz & Wendland

TABLE TOP - LAMINATE (HPL)



White (Alpino)
K1040



Kashmir
F0187



Cafe
F0903



Terril
F2297



Diamond Black
F2253



Ocean Grey
F7853



Pumice
F7858



Silver
F2791



Iron
F7902



Pale Olive
F3007



Artic Blue
F5493



Lead
F7924



Mouse
F7928

TABLE TOP - FENIX LAMINATE



Black (Nero Ingo)
0720



Bianco Male
0029



Beige Luxor
0719



Beige Arizona
0748



Castoro Ottawa
0717



Cacao Orinoco
0749



Grigio Efeso
0725



Grigio Antrim
0752



Grigio Londra
0718



Grigio Bromo
0724



Rosso Jaipur
0751



Verde Comodoro
0750



Blu Fes
0754

TABLE TOP - LINOLEUM



Black (Nero)
4023



Ash
4132



Burgundy
4154



Iron
4178



Mauve
4172



Mushrom
4176



Olive
4184



Orange Blast
4186



Pebble
4175



Pearl
4157



Pewter
4155



Pistachio
4183



Powder
4185



Salsa
4164



Smokey Blue
4179



Aquavert
4180



Spring Green
4182



Vapour
4177



Charcoal
4166



Conifer
4174



Midnight Blue
4181

LEGS / SUPPORTING FRAME



Oak
Whitepig, matt lacquer



Oak
Clear matt lacquer



T8 - TABLES

Design: Weitz & Wendland

Table top	White Laminate (HPL) *	White Laminate (HPL)	Black Fenix Laminate **	Black Fenix Laminate
Edge	Black lacquered Bevelled ***	Edge in oak	Black lacquered Bevelled ***	Edge in oak

Legs/Frame in Oak - Choose between: Whitepigmented matt lacquer / Clear matt lacquer

0-8401- 120x104xH73,5 cm

Legs: Oak lacquer

2.000

2.145

2.290

2.575

0-8403- 150x127xH73,5 cm

Legs: Oak lacquer

2.290

2.430

2.575

2.860

0-8405- 173x150xH73,5 cm

Legs: Oak lacquer

2.575

2.720

2.860

3.150

Surcharge

* Additional fee for other laminate HPL colours than white: 15%

** Black linoleum same price as black Fenix

Additional fee for other Fenix laminate and linoleum colours than black: 15%

*** Additional fee for edge in oak or edge painted in colour as laminate: 10%

PRODUCT HIGHLIGHTS

- Model 0-8401: W 24 kg / CBM 0,20

- Model 0-8403: W 34 kg / CBM 0,30

- Model 0-8405: W 45 kg / CBM 0,40

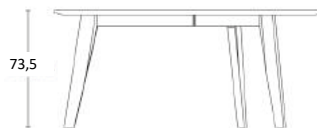
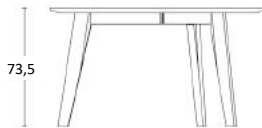
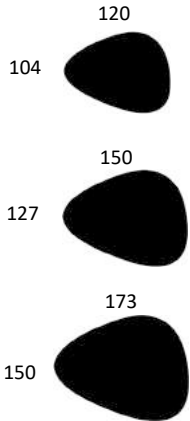

T9 - EXTENDABLE TABLE

Design: Ditlev Karsten

TABLE TOP - LAMINATE (HPL)



White (Alpino)
K1040

TABLE TOP - FENIX LAMINATE



Black (Nero Ingo)
0720

LEGS / SUPPORTING FRAME



Oak
White oil



Oak
Natural oil



Oak
Soap





T9 - EXTENDABLE TABLE

Design: byKATO

Tabletop	White Laminate (HPL)	Black Fenix Laminate
Edge	Underglued wooden edge in oak	Underglued wooden edge in oak

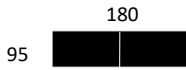

2-6402A 95x180xH74,5 cm

Storage for 2 leaves

Legs: Oak/Soap

Legs: Oak/Oil (White oil/Natural oil)

2.860

3.290

2.860

3.290



2-6400A 95x220xH74,5 cm

Storage for 4 leaves

Legs: Oak/Soap

Legs: Oak/Oil (White oil/Natural oil)

2.860

3.290

2.860

3.290

	Black Lacquer	White Laminate (HPL)	Black Fenix Laminate
Leaf *			
2-6405M22 95x45 cm	355	570	640
2-6405A 95x45 cm		570	640

* The leaf is 6mm thinner than the tabletop, so it can be stored in the magazine.



Table top and legs in solid oak

Oak Soap

Oak Oil **

2-6402M 95x180xH74,5 cm

Storage for 2 leaves

Oak

3.435

3.580

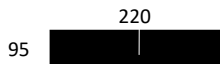

2-6400M 95x220xH74,5 cm

Storage for 4 leaves

Oak

3.435

3.580

	Anthracite grey Lacquered	Oak Soap	Oak Oil **
Leaf *			
2-6407M20 95x45 cm	355	710	785
2-6405MA 95x45 cm **		710	785

* The leaf is 6mm thinner than the tabletop, so it can be stored in the magazine.

** Oak/Oil - Choose between: White oil - Natural oil

PRODUCT HIGHLIGHTS

- Model 2-6402A/2-6402M: W 75 kg / CBM 0,22

- Model 2-6400A/2-6400M: W 86 kg / CBM 0,26

All models



Model 2-6402A / 2-6402M

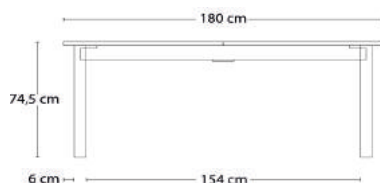

Model 2-6400A / 2-6400M

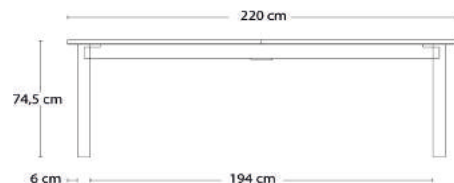



T10 - EXTENDABLE TABLE

Design: byKATO

Table top in veneer and legs in solid oak

Oak Whitepigmented
matt lacquer

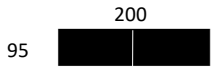

7-211020 95x200xH74,5 cm

Incl. synchronous extension

Incl. two integrated leaves, each 50 cm

2.150

Table legs



Solid Oak
White pigment.

Table top



Oak Veneer
White pigment.

PRODUCT HIGHLIGHTS

- Model 7-211020: W 75 kg / CBM 1,4

- Functional synchronised extension system that makes handling the leaf inserts especially easy

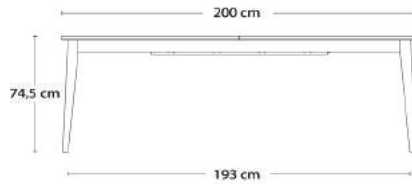



T11 - EXTENDABLE TABLE

Design: byKATO

Tabletop White laminate - Matt
(Crystal white)

Edge Wooden edge
in oak

7-311020 95x220xH74 cm

Extension for 4 leaves

Legs: Oak/Whitepigmented matt lacquer

2.575

Note: Extension leaves are only sold in boxes of 2

White laminate
w/wooden edge

White
Lacquered

Leaf

7-312020 50x95 cm

2 pcs.

710

7-312002 50x95 cm

2 pcs.

425

Table legs



Solid Oak

Table top



Pfleiderer laminate
Crystal white U11026

PRODUCT HIGHLIGHTS

- W 68 kg / CBM 0,26

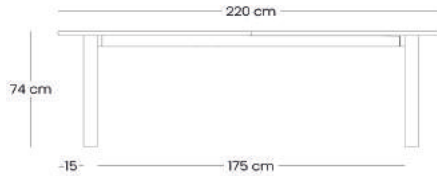
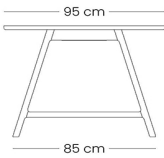

220

95

SOLUTIONS FOR CABLES & POWER

COVERS - LAMINATE (HPL)



White (Alpino)
K1040



Kashmir
F0187



Cafe
F0903



Terril
F2297



Diamond Black
F2253



Ocean Grey
F7853



Pumice
F7858



Silver
F2791



Iron
F7902



Pale Olive
F3007



Artic Blue
F5493



Lead
F7924



Mouse
F7928

COVERS - SOLID WOOD



Oak
Whitepig. matt lacquer



Oak
Clear matt lacquer



Oak
Black lacquer



Walnut
Natural oil

SOLUTIONS FOR CABLES & POWER

Covers		Veneer	Linoleum	Laminate	Solid wood
0-2005	Flip cover/Wood cover	L34 x B10 cm	580	580	580
6-1114	Drop-in Cover	L27 x B11 cm	305	305	305

Cable Tray				Black
9-7413	Cable tray for installation underneath the cable cover - length 66 cm			100
9-7416	Cable tray / Plate for HT1 high tables		Only for use with HT1 hightable	100

Power solutions

9-7403	3 pcs. 230 V - 2 pcs. Cat. 6 *	295
9-7404	2 pcs. 230 V - 1 pcs. Cat. 6 - 1 pcs. VGA with sound - 1 pcs. HDMI **	370

* The solution will be delivered with a 3 m power cable and a 0,2 m netcable with a female socket for the network

** The solution will be delivered with a 3 m power cable and a 0,2 m netcable with a female socket, VGA. HDMI to be connected directly.

Model 0-2005

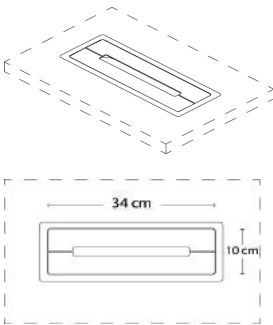

Model 6-114

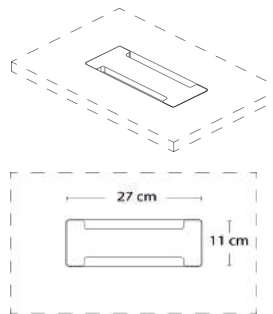

Model 9-7413

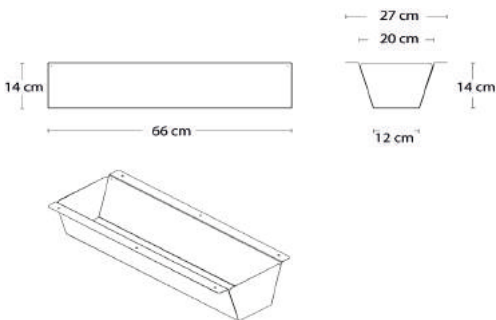

Model 9-7416

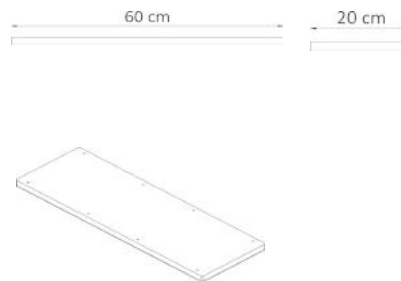

Model 9-7403

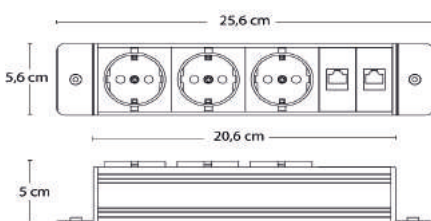

Model 9-7404

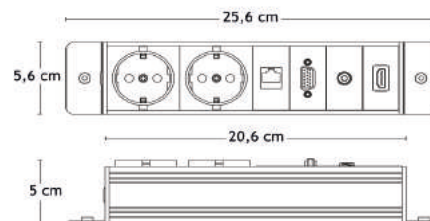



D1 - DESK

Design: byKATO

Tabletop

Linoleum
Charcoal 4166

Edge

Edge
black lacquered

2-5500 125x70xH74 cm

Legs: Oak/Whitepigmented matt lacquer

1.435

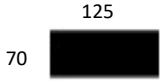

Table legs



Solid Oak

Table top



Linoleum 4166

PRODUCT HIGHLIGHTS

- W 27 kg / CBM 0,15

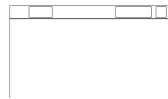
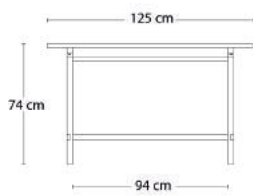

COFFEE TABLES

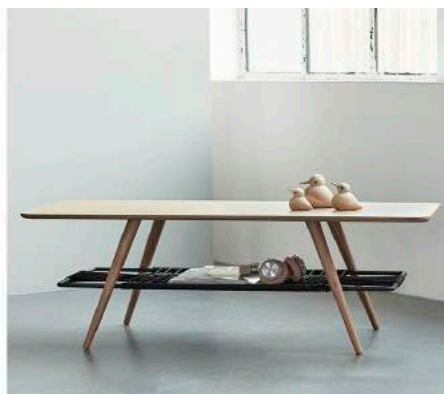

C1 - COFFEE TABLES

Design: byKATO

TABLE TOP - LAMINATE (HPL)



White (Alpino)
K1040



Kashmir
F0187



Cafe
F0903



Terril
F2297



Diamond Black
F2253



Ocean Grey
F7853



Pumice
F7858



Silver
F2791



Iron
F7902



Pale Olive
F3007



Artic Blue
F5493



Lead
F7924



Mouse
F7928

LEGS / SUPPORTING FRAME (AND TABLE TOP)



Oak
Whitepig, matt lacquer



Oak
Black lacquer

Shelf for model 2-3030

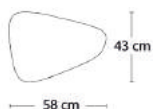

Model 2-3030

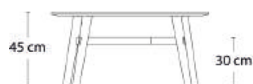

Shelf for model 2-3035

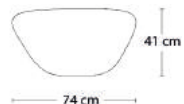

Model 2-3035

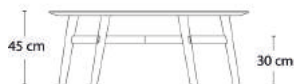

Shelf for model 2-3040

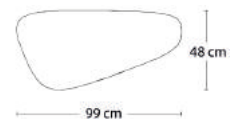

Model 2-3040



Shelf for model 2-3042

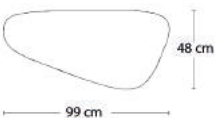

Model 2-3042



Shelf for model 2-3045

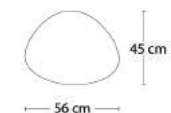

Model 2-3045

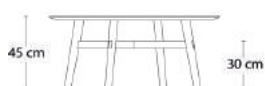



C1 - COFFEE TABLES

Design: byKATO



72

93

Tabletop

White
Laminate (HPL)

Coloured
Laminate (HPL)

2-3030LA 93x72xH45 cm

Legs: Oak/Whitepigmented mat lacquer
Legs: Oak/Black lacquered

1.070

1.070

1.070

1.070



70

120

2-3035LA 120x70xH45 cm

Legs: Oak/Whitepigmented mat lacquer
Legs: Oak/Black lacquered

1.140

1.140

1.140

1.140



83

140

2-3040LA 140x83xH45 cm

Legs: Oak/Whitepigmented mat lacquer
Legs: Oak/Black lacquered

1.285

1.285

1.285

1.285



83

140

2-3042LA 140x83xH45 cm Reversed

Legs: Oak/Whitepigmented mat lacquer
Legs: Oak/Black lacquered

1.285

1.285

1.285

1.285

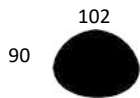

90

102

2-3045LA 102x90xH45 cm

Legs: Oak/Whitepigmented mat lacquer
Legs: Oak/Black lacquered

1.140

1.140

1.140

1.140



Table top and legs in solid oak

Oak/Whitepigm.
matt lacquer

Oak
Black lacquer



72

93

2-3030 93x72xH45 cm

Oak

1.215

1.215



70

120

2-3035 120x70xH45 cm

Oak

1.355

1.355

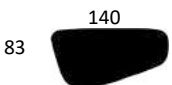

83

140

2-3040 140x83xH45 cm

Oak

1.430

1.430



83

140

2-3042 140x83xH45 cm Reversed

Oak

1.430

1.430

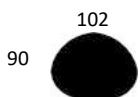

90

102

2-3045 102x90xH45 cm

Oak

1.430

1.430

Surcharge - Shelf in laminate

White
Laminate (HPL)

Coloured
Laminate (HPL)

For model 2-3030 / 2-3035

290

290

For model 2-3040 / 2-3042 / 2-3045

330

330

PRODUCT HIGHLIGHTS

- Model 2-3030: W 17 kg / CBM 0,10
- Model 2-3035: W 22 kg / CBM 0,14
- Model 2-3040 / 2-3042: W 30 kg / CBM 0,19
- Model 2-3045: W 30 kg / CBM 0,19



C2 - COFFEE TABLES

Design: Herman Studio

Table top and legs in solid oak

Oak/Whitepig.
matt lacquer

Oak
Black lacquer

Ø50



3-3601 Ø50xH43,5 cm

Oak

560

560

Ø80



3-3607 Ø80xH47,5 cm

Oak

845

845

PRODUCT HIGHLIGHTS

- Model 2-3601: W 4,75 kg / CBM 0,03
- Model 2-3607: W 6 kg / CBM 0,04

Model 3-3601



Model 3-3607

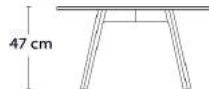



C6 - COFFEE TABLE

Design: byKATO

Tabletop

Oak Veneer
Whitepig. matt lacquer

2-3450 140x50xH42 cm

Metal frame - Black epoxy lacquered

860

140

50

PRODUCT HIGHLIGHTS

- Model 3-3450: W 20 kg / CBM 0,10

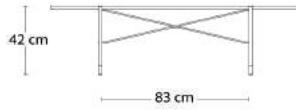



C7 - COFFEE TABLES

Design: Louise Siig Nielsen

50 120

Tabletop

Oak veneer
Whitepigm. Mat lacquer

Oak veneer
Black lacquer

2-3500 120x50xH45 cm

Shelf in black braided

Legs: Oak

1.005

1.005

PRODUCT HIGHLIGHTS

- Model 2-3500: W 14 kg / CBM 0,27

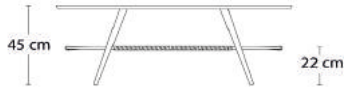

CHAIRS



FABRIC OVERVIEW - CHAIRS

FABRIC GROUP 1



Xtreme - Camira

FABRIC GROUP 2



Cura - Gabriel



Fame - Gabriel

Floyd - Kvadrat



Remix - Kvadrat



Repetto - Gabriel



Step Melange - Gabriel

FABRIC GROUP 3



Canvas - Kvadrat



Capture - Gabriel

Illusion - Nevotex



Re-wool - Kvadrat

FABRIC GROUP 4



Fiord 2 - Kvadrat

FABRIC GROUP 5

Comfort - Gabriel



Divina 3 - Kvadrat



Divina Melange 3 - Kvadrat



Hallingdal - Kvadrat

Passport black leather - Nevotex



Steelcut Trio - Kvadrat



Steelcut Quartet - Kvadrat

FABRIC GROUP 6



Vidar 3 - Kvadrat



Steelcut 2 - Kvadrat

Dakar leather - Nevotex *



Certified with EU Ecolabel. For more information, please visit the website of the fabric manufacturer.

Mood is EU Ecolabel certified with the following fabrics.

* Minimum 4 chairs

AC2 - CHAIRS

Design: byKATO

BASE/LEGS (AND SEAT)



Oak

Whitepig. matt lacquer



Oak

Clear matt lacquer



Oak

Black lacquer



Oak

Smoked oil

UPHOLSTERY - LEATHER: Standard leather - Black or Cognac



Black
Leather



Cognac
Leather

UPHOLSTERY - FABRIC: See page 89 for fabric groups



AC2 - CHAIR

Design: byKATO



58



74



53



Frame	Oak Lacquer	Oak Smoked oil			
2-803 B58xD53xH74 cm Chair with seat in oak veneer	460	460			
2-805 B58xD53xH74 cm Chair with upholstered seat - Standard leather: Black / Cognac	545	545			
2-805- B58xD53xH74 cm Chair with upholstered seat - Fabric gr. 1: Xtreme / Camira Fabrics	505	505			
Surcharge Fabric group (Fabric overview p. 89)	Gr. 2 20	Gr. 3 30	Gr. 4 35	Gr. 5 50	Gr. 6 * 105
2-807 B58xD53xH74 cm Chair with upholstered seat and back - Standard leather: Black	645	645			

* Minimum 4 chairs

Note: AC2 chair with upholstered back is not available with a black lacquered frame

Frame colour

Oak / Lacquer

Whitepigm. matt lacquer

Clear matt lacquer

Black lacquered

Oak / Smoked oil

Smoked oil

PRODUCT HIGHLIGHTS

- W 6 kg / CBM 0,18 (Not stackable) Colli 2 pcs.
- The AC2 chair fulfils the requirements in EN 1022:2005 and EN 16139:2013. Furniture - Strength, durability and safety.



DRY - CHAIRS

Design: Komplot

SHELL COLOURS - GROUP 1



Black
RAL 9005



Sandy Grey
NCS 5502Y

ARMRESTS



Black Plastic
RAL 9005

SHELL COLOURS - GROUP 2



Dark Petrol
NCS 7010 B10G



Light Sandy Grey
NCS 2502Y



Dusty Olive
RAL 7009



Terracotta
RAL 8002



Warm Charcoal
RAL 7022

FRAME COLOURS - GROUP 1

(Dry Outdoor - Only black frame)



Black
RAL 9005



Sandy Grey
NCS 5502Y



Chrome

FRAME COLOURS - GROUP 2



Dark Petrol
NCS 7010 B10G



Light Sandy Grey
NCS 2502Y



Dusty Olive
RAL 7009



Terracotta
RAL 8002



Warm Charcoal
RAL 7022



Satin Chrome





DRY - CHAIR



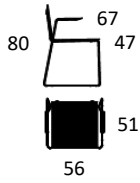
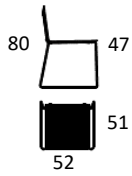



Design: Komplot



Frame	Frame colour	Frame colour
	Gr. 1	Gr. 2







D1000

Shell in PUR

Shell colour gr. 1	 	459	474
Shell colour gr. 2	    	474	490

D1050

Shell in PUR

Shell colour gr. 1	 	587	603
Shell colour gr. 2	    	603	617

Surcharge

Linking device integrated in seat	18
Linking device integrated in the frame (only D1000 chrome / satin)	62
Felt glides, set	8

Frame colour

Grp. 1



Grp. 2



PRODUCT HIGHLIGHTS

- Passed L2 test (extreme use)
- Adapts to the shape of the body providing both support and comfort
- Sound-absorbing material
- Available with linking device (under seat or integrated in the frame)
- Armchairs can hang on the edge of the table
- Available with chair hanger
- Can stack up to 15 high on the floor
- Can stack up to 20 chairs on the trolley
- Easy to clean, can withstand ethanol-based disinfectants
- Soft-touch surface and solution dyed material
- Weight: Dry 5,7 kg.
- Weight: Dry armchair 6,5 kg.



DRY - BAR STOOL

Design: Komplot

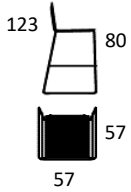
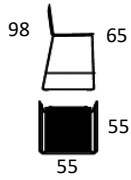

Frame	Frame colour	
	Gr. 1	Gr. 2
DB1175		
Shell in PUR		
Shell colour gr. 1		669 683
Shell colour gr. 2		683 697
DB1276		
Shell in PUR		
Shell colour gr. 1		697 714
Shell colour gr. 2		714 728
Surcharge		
Felt glides, set		8
Frame colour		
Grp. 1		
Grp. 2		

PRODUCT HIGHLIGHTS

- Adapts to the shape of the body providing both support and comfort
- Sound-absorbing material
- Available with chair hanger
- Can stack up to 4 high on the floor
- Easy to clean, can withstand ethanol-based disinfectants
- Soft-touch surface and solution dyed material
- Weight: Dry barchair low 7,5 kg.
- Weight: Dry barchair high 8 kg.



DRY OUTDOOR - CHAIR

Design: Komplot

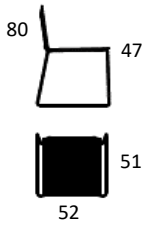

Frame

Frame colour
Black

DO10000

Shell in PUR

Shell colour gr. 1



453

Shell colour gr. 2



468

Frame colour



Black

PRODUCT HIGHLIGHTS

- Weatherproof materials
- Molds to your body
- Providing both support and comfort
- Soft-touch surface
- Durable and versatile
- Can stack up to 15 chairs
- Shell available in 7 colors
- Easy to clean, withstands disinfection
- Soft-touch surface and solution dyed material
- Passed L2 test (extreme use)



HC1 - BAR STOOL

Design: Anne Qvist

Legs	Oak/Whitepig. matt lacquer	Oak Black lacquer
Footrest	Brushed steel	Black metal

Height 67 cm

0-880L0101	B39xD32xH67 cm		405		
Veneer seat - Black					
0-880L0103	B39xD32xH67		445		
Aston PU leather seat - Black					
0-880L0302	B39xD32xH67		405		
Veneer seat - Oak					
0-880L0303	B39xD32xH67		445		
Aston PU leather seat - Black					
0-881L-	B39xD32xH67		450		
Upholstered seat - Fabric gr. 1: Xtreme / Camira Fabrics			450		
Surcharge Fabric group (Fabric overview p. 89)	Gr. 2	Gr. 3	Gr. 4	Gr. 5	Gr. 6
	20	30	35	50	105

Height 80 cm

0-885H0101	B39xD35xH80 cm		415		
Veneer seat - Black					
0-885H0103	B39xD35xH80 cm		460		
Aston PU leather seat - Black					
0-885H0302	B39xD35xH80 cm		415		
Veneer seat - Oak					
0-885H0303	B39xD35xH80 cm		460		
Aston PU leather seat - Black					
0-886H-	B39xD35xH80 cm		465		
Upholstered seat - Fabric gr. 1: Xtreme / Camira Fabrics			465		
Surcharge Fabric group (Fabric overview p. 89)	Gr. 2	Gr. 3	Gr. 4	Gr. 5	Gr. 6
	20	30	35	50	105

Mounting	
0-888 - Mounting for 1 chair	40

Frame colour		
Oak/Lacquer	Whietpig. matt lacquer	Black lacquer

PRODUCT HIGHLIGHTS

- Model 0-880 W 3,5 kg / 0-885: W 4 kg / CBM 0,18 (Not stackable)
- Chair glides with and without included
- The HC1 chair fulfils the requirements in EN 1022:2005 and EN 16139:2013. Furniture - Strength, durability and safety.

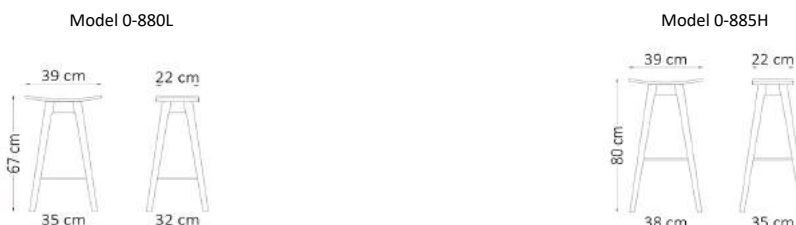



HC2 - BAR STOOL

Design: byKATO

Frame

Black
Structure painted frame

Height 65 cm

0-860L0213FSC B41xD30xH65 cm

Seat in oak/whitepig. matt lacquer



275

0-860L0509FSC B41xD30xH65 cm

Seat in oak/black lacquer



275

Height 79 cm

0-865H0213FSC B44xD33xH79 cm

Seat in oak/whitepig. matt lacquer



290

0-865H0509FSC B44xD33xH79 cm

Seat in oak/black lacquer



290

Mounting

0-888 - Mounting for 1 chair

40

Frame colour



Black structure painted

PRODUCT HIGHLIGHTS

- Model 0-860L: W 5 kg / CBM 0,10 (Not stackable)
- Model 0-860H: W 5,25 kg / CBM 0,10 (Not stackable)
- Felt floor proctector mounted
- Seat size: 39x24 cm
- Delivered "Knock down"
- The HC2 chair fulfils the requirements in EN 1022:2005 and EN 16139:2013. Furniture - Strength, durability and safety.

Model 0-860L

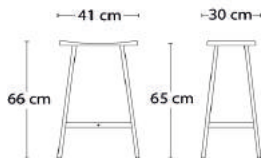

Model 0-865H

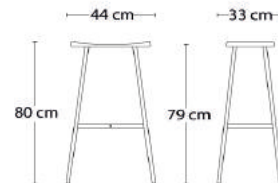



HC3 - BAR STOOL

Design: Andersen Design Team

Frame og seat in solid wood

Oak
Whitepig. matt lacquer



Height 63 cm

0-850L

B36xD42xH63 cm

Oak



345

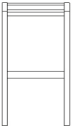

Height 78 cm

0-850H

B36xD42xH63 cm

Oak



360

PRODUCT HIGHLIGHTS

- Model 0-850L: W 3,5 kg / CBM 0,10 (Not stackable)
- Model 0-850H: W 4 kg / CBM 0,13 (Not stackable)
- The HC3 chair fulfils the requirements in EN 1022:2005 and EN 16139:2013. Furniture - Strength, durability and safety.

Model 0-850L

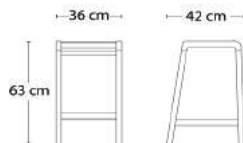

Model 0-850H

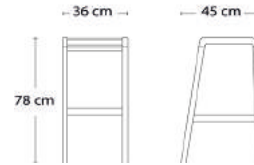



LC1 - LOUNGECHAIR

Design: Andersen Design Team

Upholstery	Black Leather	Cognac Leather
3-620 B72xD82xH77xSH42 cm		
Legs: Oak/Whitepigmented mat lacquer	1.860	1.860
Legs: Oak/Black lacquered	1.860	

Leather



Sevilla S4001 (Black)



Sevilla S4003 (Cognac)

Sevilla is a light-corrected semianiline leather with a thickness of 1,5-2 mm

PRODUCT HIGHLIGHTS

- Model 3-620: W 21 kg / CBM 0,6

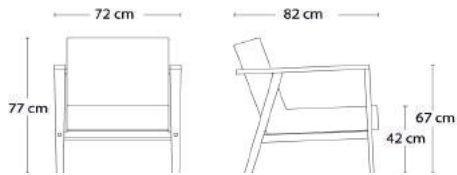

MOOD - CHAIRS

Design: Hans-Thyge & Co.

SHELL COLOURS - GROUP 1



Black
RAL 9005



Light Grey
RAL 7042

ARMRESTS



Black Plastic
RAL 9005

SHELL COLOURS - GROUP 2



Dark Petrol
NCS 7010 B10G



Dusty Light Blue
NCS 3010 B10G



Dusty Green
NCS S6010 G10Y



Dusty Pink
NCS S2020 Y80R

FRAME COLOURS - GROUP 1



Black
RAL 9005



Sandy Grey
RAL 7042



Chrome

FRAME COLOURS - GROUP 2



Dark Petrol
NCS 7010 B10G



Dusty Light Blue
NCS 3010 B10G



Dusty Green
NCS S6010 G10Y



Dusty Pink
NCS S2020 Y80R



Satin Chrome



18 chairs of the Mood collection are certified according to the EU Ecolabel
Winner of the German Design Award 2019 - Excellent Product Design.









MOOD 4-LEGS - CHAIR

Design: Hans-Thyge & Co.

Frame	Frame colour	
	Gr. 1	Gr. 2







MO1200

Shell in PP

Shell colour gr. 1	 	254	271
Shell colour gr. 2	   	271	285

MO1205

Upholstered seat pad (Fabric group 1: Xtreme / Camira Fabrics)

Shell colour gr. 1	 	386	400
Shell colour gr. 2	   	400	414

Surcharge Fabric group (Fabric overview p. 89)	Gr. 2	Gr. 3	Gr. 4	Gr. 5	Gr. 6 *
	12	23	43	72	84

MO1210

Fully upholstered (Fabric group 1: Xtreme / Camira Fabrics)

582 **597**

Surcharge Fabric group (Fabric overview p. 89)	Gr. 2	Gr. 3	Gr. 4	Gr. 5	Gr. 6 *
	35	62	123	205	238

* Minimum 4 chairs

Surcharge

Felt glides, set	14
Stacking shield	57

Frame colour

Grp. 1	 Black	 Light grey	 Chrome		
Grp. 2	 Dark petrol Petrol	 Dusty Light Blue	 Dusty Green	 Dusty Pink	 Satin Chrome

PRODUCT HIGHLIGHTS

- EU Ecolabel certified (black shell)
- Passed L2 (extreme use)
- Shell made from 100% upcycled black PP (polypropylene)
- The metal frame is made from 45% steel
- Disposal: can easily be separated in each material
- The dotted texture reduces marks and has an anti-slippery effect
- Armchairs can hang on the edge of the table
- Available with chair hanger
- Tilt glides with acoustic properties
- Can stack up to 10 high on the floor (w/o armrests)
- Can stack up to 20 chairs on the trolley
- Weight: Mood 4-Legs: 4,8 kg
- Weight: Mood 4-Legs armchair: 5,3 kg





MOOD 4-LEGS - ARM CHAIR



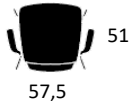



Design: Hans-Thyge & Co.



Frame	Frame colour	
	Gr. 1	Gr. 2







MO1250

Shell in PP

Shell colour gr. 1	 	361	375
Shell colour gr. 2	   	375	392

MO1255

Upholstered seat pad (Fabric group 1: Xtreme / Camira Fabrics)

Shell colour gr. 1	 	494	509
Shell colour gr. 2	   	509	523

Surcharge Fabric group (Fabric overview p. 89)	Gr. 2	Gr. 3	Gr. 4	Gr. 5	Gr. 6 *
	12	23	43	72	84

MO1260

Fully upholstered (Fabric group 1: Xtreme / Camira Fabrics)

691 **705**

Surcharge Fabric group (Fabric overview p. 89)	Gr. 2	Gr. 3	Gr. 4	Gr. 5	Gr. 6 *
	35	62	123	205	238

* Minimum 4 chairs

Surcharge

Felt glides, set	14
Stacking shield	57

Frame colour

Grp. 1	 Black	 Light grey	 Chrome		
Grp. 2	 Dark petrol Petrol	 Dusty Light Blue	 Dusty Green	 Dusty Pink	 Satin Chrome

PRODUCT HIGHLIGHTS

- EU Ecolabel certified (black shell)
- Passed L2 (extreme use)
- Shell made from 100% upcycled black PP (polypropylene)
- The metal frame is made from 45% steel
- Disposal: can easily be separated in each material
- The dotted texture reduces marks and has an anti-slippery effect
- Armchairs can hang on the edge of the table
- Available with chair hanger
- Tilt glides with acoustic properties
- Can stack up to 10 high on the floor (w/o armrests)
- Can stack up to 20 chairs on the trolley
- Weight: Mood 4-Legs: 4,8 kg
- Weight: Mood 4-Legs armchair: 5,3 kg





MOOD TUBE - CHAIR

Design: Hans-Thyge & Co.

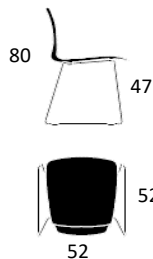

Frame		Frame colour Gr. 1	Frame colour Gr. 2
MO1000			
Shell in PP			
Shell colour gr. 1		291	306
Shell colour gr. 2		306	320
MO1005			
Upholstered seat pad (Fabric group 1: Xtreme / Camira Fabrics)			
Shell colour gr. 1		422	437
Shell colour gr. 2		437	451
Surcharge Fabric group (Fabric overview p. 89)	Gr. 2 12	Gr. 3 23	Gr. 4 43
	Gr. 5 72	Gr. 6 * 84	
MO1010			
Fully upholstered (Fabric group 1: Xtreme / Camira Fabrics)			
Surcharge Fabric group (Fabric overview p. 89)	Gr. 2 35	Gr. 3 62	Gr. 4 123
	Gr. 5 205	Gr. 6 * 238	

Surcharge		
Felt glides, set		8
Stacking shield		57
Linking device integrated in the frame (chairs w/o armrest chrome / satin)		62

* Minimum 4 chairs

Frame colour	
Grp. 1	
Grp. 2	

PRODUCT HIGHLIGHTS

- Shell made from 100% upcycled black PP (polypropylene)
- The metal frame is made from 45% steel
- Disposal: can easily be separated in each material
- The dotted texture reduces marks and has an anti-slippery effect
- Armchairs can hang on the edge of the table
- Available with chair hanger
- Linking device possible (only MO1000, MO1005, MO1010)
- Can stack up to 10 high on the floor (w/o armrests)
- Can stack up to 20 chairs on the trolley
- Weight: Mood Tube: 5,4 kg.
- Weight: Mood Tube armchair: 6 kg.



MOOD TUBE - ARM CHAIR

Design: Hans-Thyge & Co.

Frame	Frame colour	
	Gr. 1	Gr. 2

MO1050

Shell in PP

Shell colour gr. 1		400	414
Shell colour gr. 2		414	429

MO1055

Upholstered seat pad (Fabric group 1: Xtreme / Camira Fabrics)

Shell colour gr. 1		529	546
Shell colour gr. 2		546	560

Surcharge Fabric group (Fabric overview p. 89)	Gr. 2	Gr. 3	Gr. 4	Gr. 5	Gr. 6 *
	12	23	43	72	84

MO1060

Fully upholstered (Fabric group 1: Xtreme / Camira Fabrics)

Surcharge Fabric group (Fabric overview p. 89)	Gr. 2	Gr. 3	Gr. 4	Gr. 5	Gr. 6 *
	35	62	123	205	238

* Minimum 4 chairs

Surcharge

Felt glides, set	8
Stacking shield	57

Frame colour

Grp. 1	
Grp. 2	

PRODUCT HIGHLIGHTS

- Shell made from 100% upcycled black PP (polypropylene)
- The metal frame is made from 45% steel
- Disposal: can easily be separated in each material
- The dotted texture reduces marks and has an anti-slippery effect
- Armchairs can hang on the edge of the table
- Available with chair hanger
- Linking device possible (only MO1000, MO1005, MO1010)
- Can stack up to 10 high on the floor (w/o armrests)
- Can stack up to 20 chairs on the trolley
- Weight: Mood Tube: 5,4 kg.
- Weight: Mood Tube armchair: 6 kg.

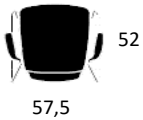
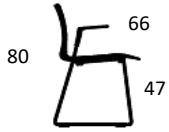



MOOD LOW - BAR CHAIR

Design: Hans-Thyge & Co.

Frame	Frame colour	
	Gr. 1	Gr. 2

MOB1075

Shell in PP

Shell colour gr. 1		412	427
Shell colour gr. 2		427	441

MOB1175

Upholstered seat pad (Fabric group 1: Xtreme / Camira Fabrics)

Shell colour gr. 1		546	560
Shell colour gr. 2		560	574

Surcharge Fabric group (Fabric overview p. 89)	Gr. 2	Gr. 3	Gr. 4	Gr. 5	Gr. 6 *
	12	23	43	72	84

MOB1275

Fully upholstered (Fabric group 1: Xtreme / Camira Fabrics)

Surcharge Fabric group (Fabric overview p. 89)	Gr. 2	Gr. 3	Gr. 4	Gr. 5	Gr. 6 *
	35	62	123	205	238

* Minimum 4 chairs

Surcharge

Felt glides, set	8
Stacking shield	57

Frame colour

Grp. 1	
Grp. 2	

PRODUCT HIGHLIGHTS

- Shell made from 100% upcycled black PP (polypropylene)
- The metal frame is made from 45% steel
- Disposal: can easily be separated in each material
- The dotted texture reduces marks and has an anti-slippery effect
- Available with chair hanger
- Can stack up to 4 high on the floor
- Weight: Mood Bar low: 6,2 kg.
- Weight: Mood Bar high 6,5 kg.

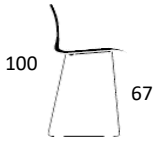



MOOD HIGH - BAR CHAIR

Design: Hans-Thyge & Co.

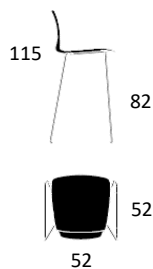

Frame		Frame colour Gr. 1	Frame colour Gr. 2		
MOB1076					
Shell in PP					
Shell colour gr. 1		443	457		
Shell colour gr. 2		457	472		
MOB1176					
Upholstered seat pad (Fabric group 1: Xtreme / Camira Fabrics)					
Shell colour gr. 1		574	589		
Shell colour gr. 2		589	603		
Surcharge Fabric group (Fabric overview p. 89)	Gr. 2 12	Gr. 3 23	Gr. 4 43	Gr. 5 72	Gr. 6 * 84
MOB1276					
Fully upholstered (Fabric group 1: Xtreme / Camira Fabrics)					
Surcharge Fabric group (Fabric overview p. 89)	Gr. 2 35	Gr. 3 62	Gr. 4 123	Gr. 5 205	Gr. 6 * 238
* Minimum 4 chairs					
Surcharge					
Felt glides, set					8
Stacking shield					57

Frame colour					
Grp. 1					
	Black	Light grey	Chrome		
Grp. 2					
	Dark petrol Petrol	Dusty Light Blue	Dusty Green	Dusty Pink	Satin Chrome

PRODUCT HIGHLIGHTS

- Shell made from 100% upcycled black PP (polypropylene)
- The metal frame is made from 45% steel
- Disposal: can easily be separated in each material
- The dotted texture reduces marks and has an anti-slippery effect
- Available with chair hanger
- Can stack up to 4 high on the floor
- Weight: Mood Bar low: 6,2 kg.
- Weight: Mood Bar high 6,5 kg.





MOOD CONFERENCE - CHAIR





Design: Hans-Thyge & Co.

Frame	Frame colour Gr. 1
-------	-----------------------

MO1400



Shell in PP





Shell colour gr. 1	 	617
--------------------	---	------------

Shell colour gr. 2	   	632
--------------------	---	------------

MO1405

Upholstered seat pad (Fabric group 1: Xtreme / Camira Fabrics)

Shell colour gr. 1	 	749
--------------------	---	------------

Shell colour gr. 2	   	763
--------------------	---	------------

Surcharge Fabric group (Fabric overview p. 89)	Gr. 2	Gr. 3	Gr. 4	Gr. 5	Gr. 6 *
	12	23	43	72	84

MO1410



Fully upholstered (Fabric group 1: Xtreme / Camira Fabrics)





945

Surcharge Fabric group (Fabric overview p. 89)	Gr. 2	Gr. 3	Gr. 4	Gr. 5	Gr. 6 *
	35	62	123	205	238

MO1450



Shell in PP





Shell colour gr. 1	 	728
--------------------	---	------------

Shell colour gr. 2	   	742
--------------------	---	------------

MO1455

Upholstered seat pad (Fabric group 1: Xtreme / Camira Fabrics)

Shell colour gr. 1	 	857
--------------------	---	------------

Shell colour gr. 2	   	872
--------------------	---	------------

Surcharge Fabric group (Fabric overview p. 89)	Gr. 2	Gr. 3	Gr. 4	Gr. 5	Gr. 6
	12	23	43	72	84

MO1460

Fully upholstered (Fabric group 1: Xtreme / Camira Fabrics)

1.054

Surcharge Fabric group (Fabric overview p. 89)	Gr. 2	Gr. 3	Gr. 4	Gr. 5	Gr. 6
	35	62	123	205	238

* Minimum 4 chairs

Frame colour

Grp. 1



PRODUCT HIGHLIGHTS

- EU Ecolabel certified (black shell)
- Passed L2 (extreme use)
- Shell made from 100% upcycled black PP (polypropylene)
- Disposal: can easily be separated in each material
- The dotted texture reduces marks and has an anti-slippery effect
- Armchairs can hang on the edge of the table
- The chair has an integrated tilt system
- Armrests can be retrofitted
- Weight: Mood Conference: 7,7 kg.
- Weight: Mood Conference armchair: 8,7 kg.





MOOD WOOD - CHAIR

Design: Hans-Thyge & Co.

Frame

Frame colour

Gr. 1

MO1300

Shell in PP

Shell colour gr. 1



484

Shell colour gr. 2



498

MO1305

Upholstered seat pad (Fabric group 1: Xtreme / Camira Fabrics)

Shell colour gr. 1



615

Shell colour gr. 2



630

Surcharge Fabric group
(Fabric overview p. 89)

Gr. 2

Gr. 3

Gr. 4

Gr. 5

Gr. 6 *

12

23

43

72

84

MO1310

Fully upholstered (Fabric group 1: Xtreme / Camira Fabrics)

812

Surcharge Fabric group
(Fabric overview p. 89)

Gr. 2

Gr. 3

Gr. 4

Gr. 5

Gr. 6 *

35

62

123

205

238

* Minimum 4 chairs

Surcharge

Felt glides, set

8

Frame colour

Grp. 1



White tinted oak



Black lacquered oak

PRODUCT HIGHLIGHTS

- Passed L2 (extreme use)
- Shell made from 100% upcycled black PP (polypropylene)
- The wooden frame comes from FSC certified forests
- Disposal: can easily be separated in each material
- Metal frame is supplied in shell colour/black when fully upholstered
- The dotted texture reduces marks and has an anti-slippery effect
- Possibility of writing board
- Weight: Mood Wood: 5,4 kg.





MOOD CLASSIC - CHAIR

Design: Hans-Thyge & Co.

Frame

Frame colour

Gr. 1

MOC1600

Shell in PP

Shell colour gr. 1



701

Shell colour gr. 2



716

MOC1605

Upholstered seat pad (Fabric group 1: Xtreme / Camira Fabrics)

Shell colour gr. 1



833

Shell colour gr. 2



847

Surcharge Fabric group
(Fabric overview p. 89)

Gr. 2

Gr. 3

Gr. 4

Gr. 5

Gr. 6 *

12

23

43

72

84

MOC1610

Fully upholstered (Fabric group 1: Xtreme / Camira Fabrics)

1.030

Surcharge Fabric group
(Fabric overview p. 89)

Gr. 2

Gr. 3

Gr. 4

Gr. 5

Gr. 6 *

35

62

123

205

238

* Minimum 4 chairs

Surcharge

Felt glides, set

8

Frame colour

Grp. 1



White tinted oak



Black lacquered oak

PRODUCT HIGHLIGHTS

- Passed L1
- Shell made from 100% upcycled black PP (polypropylene)
- The wooden frame comes from FSC certified forests
- Disposal: can easily be separated in each material
- The dotted texture reduces marks and has an anti-slippery effect
- Weight: Mood Classic: 6,7 kg.





MOOD LEARN - CHAIR

Design: Hans-Thyge & Co.

Frame	Frame colour Gr. 1
-------	-----------------------

MOL1500

Shell in PP

Shell colour gr. 1		394
Shell colour gr. 2		408

MOL1505

Upholstered seat pad (Fabric group 1: Xtreme / Camira Fabrics)

Shell colour gr. 1		525
Shell colour gr. 2		539

Surcharge Fabric group (Fabric overview p. 89)	Gr. 2	Gr. 3	Gr. 4	Gr. 5	Gr. 6 *
	12	23	43	72	84

MOL1510

Fully upholstered (Fabric group 1: Xtreme / Camira Fabrics)

Surcharge Fabric group (Fabric overview p. 89)	Gr. 2	Gr. 3	Gr. 4	Gr. 5	Gr. 6 *
	35	62	123	205	238

* Minimum 4 chairs

Surcharge

Glides	0
Wheels with brakes when not strained, set	14
Gas-lift, H 47-65 cm	14
Footrest (loose)	84

Frame colour

Grp. 1 Aluminum polished / black

PRODUCT HIGHLIGHTS

- EU Ecolabel certified (black shell)
- Passed L2 (extreme use)
- Shell made from 100% upcycled black PP (polypropylene)
- Disposal: can easily be separated in each material
- Metal frame is supplied in shell colour/black when fully upholstered
- The dotted texture reduces marks and has an anti-slippery effect
- Armchairs can hang on the edge of the table
- Available with chair hanger
- The chair has an integrated tilt system
- Weight: Mood Learn: 8,1 kg.
- Weight: Mood Learn w. footrest: 9,1 kg.
- Weight: Mood Learn armchair: 9,1 kg.





MOOD LEARN - ARM CHAIR

Design: Hans-Thyge & Co.

Frame	Frame colour Gr. 1
-------	-----------------------

MOL1550

Shell in PP

Shell colour gr. 1		502
Shell colour gr. 2		519

MOL1555

Upholstered seat pad (Fabric group 1: Xtreme / Camira Fabrics)

Shell colour gr. 1		634
Shell colour gr. 2		648

Surcharge Fabric group (Fabric overview p. 89)	Gr. 2	Gr. 3	Gr. 4	Gr. 5	Gr. 6 *
	12	23	43	72	84

MOL1560

Fully upholstered (Fabric group 1: Xtreme / Camira Fabrics)

831

Surcharge Fabric group (Fabric overview p. 89)	Gr. 2	Gr. 3	Gr. 4	Gr. 5	Gr. 6 *
	35	62	123	205	238

* Minimum 4 chairs

Surcharge

Glides	0
Wheels with brakes when not strained, set	14
Gas-lift, H 47-65 cm	14
Footrest (loose)	84

Frame colour

Grp. 1 Aluminum polished / black

PRODUCT HIGHLIGHTS

- EU Ecolabel certified (black shell)
- Passed L2 (extreme use)
- Shell made from 100% upcycled black PP (polypropylene)
- Disposal: can easily be separated in each material
- Metal frame is supplied in shell colour/black when fully upholstered
- The dotted texture reduces marks and has an anti-slippery effect
- Armchairs can hang on the edge of the table
- Available with chair hanger
- The chair has an integrated tilt system
- Weight: Mood Learn: 8,1 kg.
- Weight: Mood Learn w. footrest: 9,1 kg.
- Weight: Mood Learn armchair: 9,1 kg.

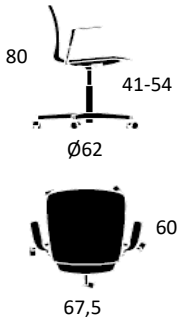



MOOD LEARN - CHAIR

Design: Hans-Thyge & Co.

Frame

Frame colour

Gr. 1

MOLF1500

Shell in PP

Shell colour gr. 1



513

Shell colour gr. 2



527

MOLF1505

Upholstered seat pad (Fabric group 1: Xtreme / Camira Fabrics)

Shell colour gr. 1



644

Shell colour gr. 2



658

Surcharge Fabric group
(Fabric overview p. 89)

Gr. 2

Gr. 3

Gr. 4

Gr. 5

Gr. 6 *

12

23

43

72

84

MOLF1510

Fully upholstered (Fabric group 1: Xtreme / Camira Fabrics)

843

Surcharge Fabric group
(Fabric overview p. 89)

Gr. 2

Gr. 3

Gr. 4

Gr. 5

Gr. 6 *

35

62

123

205

238

* Minimum 4 chairs

Surcharge

Glides

0

Wheels with brakes when not strained, set

14

Footrest (loose)

84

Frame colour

Grp. 1 Aluminum polished / black

PRODUCT HIGHLIGHTS

- EU Ecolabel certified (black shell)
- Passed L2 (extreme use)
- Shell made from 100% upcycled black PP (polypropylene)
- Disposal: can easily be separated in each material
- Metal frame is supplied in shell colour/black when fully upholstered
- The dotted texture reduces marks and has an anti-slippery effect
- Armchairs can hang on the edge of the table
- Available with chair hanger
- The chair has an integrated tilt system
- Weight: Mood Learn: 8,1 kg.
- Weight: Mood Learn w. footrest: 9,1 kg.
- Weight: Mood Learn armchair: 9,1 kg.





MUST - CHAIR

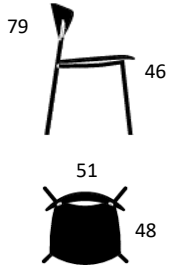

Design: Hans-Thyge & Co.



Frame	Frame colour Gr. 1
-------	-----------------------



M1000

Seat / back in wood

Seat / back in birch		345
Seat / back in black ash		371

M1100

Upholstered seat (Fabric group 1: Xtreme / Camira Fabrics) / back in wood

Back in birch		400
Back in black ash		427

Surcharge Fabric group (Fabric overview p. 89)	Gr. 2	Gr. 3	Gr. 4	Gr. 5	Gr. 6 *
	12	23	43	72	84

* Minimum 4 chairs

Surcharge

Linking device	41
Felt glides, set	8

Frame colour

Grp. 1



Chrome

PRODUCT HIGHLIGHTS

- Can stack up to 7 high on the floor
- Available with chair hanger
- Available with linking device
- Weight: Must 4,8 kg.

PURE - CHAIRS

Design: Thore Lassen Design

SHELL COLOURS - GROUP 1



Black
RAL 9005



Sandy Grey
NCS 5502Y

SHELL COLOURS - GROUP 2



Dark Petrol
NCS 7010 B10G



Light Sandy Grey
NCS 2502Y



Dusty Olive
RAL 7009



Terracotta
RAL 8002



Warm Charcoal
RAL 7022

FRAME COLOURS - GROUP 1



Black
RAL 9005



Sandy Grey
NCS 5502Y



Chrome

FRAME COLOURS - GROUP 2



Dark Petrol
NCS 7010 B10G



Light Sandy Grey
NCS 2502Y



Dusty Olive
RAL 7009



Terracotta
RAL 8002



Warm Charcoal
RAL 7022



Satin Chrome









PURE - CHAIR

Design: Thore Lassen Design



51

Frame	Frame colour Gr. 1	Frame colour Gr. 2			
P1000					
Seat / back in PUR					
Seat / back colour gr. 1		377 392			
Seat / back colour gr. 2		392 406			
P1100					
Upholstered seat (Fabric group 1: Xtreme / Camira Fabrics) / back in PUR					
Seat / back colour gr. 1		433 447			
Seat / back colour gr. 2		447 461			
Surcharge Fabric group (Fabric overview p. 89)	Gr. 2 12	Gr. 3 23	Gr. 4 43	Gr. 5 72	Gr. 6 * 84
* Minimum 4 chairs					
Surcharge					
Linking device - P1000 & P1100 only					41
Felt glides, set					14

Frame colour

Grp. 1



Grp. 2



PRODUCT HIGHLIGHTS

- Passed L2 (extreme use)
- Sound absorbing material
- Tilt glides with acoustic properties
- Linking device is available
- Chair hanger is available
- Can stack up to 12 high on the floor
- Easy to clean, can withstand ethanol-based disinfectants
- Soft-touch surface and solution dyed material
- Weight: Pure 5,5 kg.



PURE - STOOL / BAR STOOL

Design: Thore Lassen Design



47

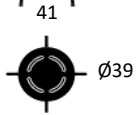

41

Ø39

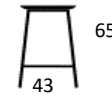

65

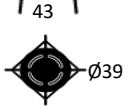

43

Ø39

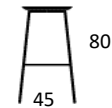

80



45

Ø39

Frame		Frame colour Gr. 1	Frame colour Gr. 2
PT1074			
Seat in PUR			
Seat colour gr. 1		238	240
Seat back colour gr. 2		240	248
PB1075			
Seat in PUR			
Seat colour gr. 1		306	320
Seat back colour gr. 2		320	326
PB1076			
Seat in PUR			
Seat colour gr. 1		334	351
Seat back colour gr. 2		351	357
Surcharge			
Felt glides, set			14

Frame colour

Grp. 1



Black



Sandy grey



Chrome

Grp. 2



Dark petrol
Petrol



Light
Sandy grey



Dusty
Olive



Terracotta



Warm
Charcoal



Satin
Chrome

PRODUCT HIGHLIGHTS

- Sound absorbing material
- Tilt glides with acoustic properties
- Can stack up to 10 high on the floor (Pure stool)
- Easy to clean, can withstand ethanol-based disinfectants
- Soft-touch surface and solution dyed material
- Weight: Pure stool 3,5 kg.
- Weight: Pure Bar low 4,5 kg.
- Weight: Pure Bar high 5 kg.



PURE - BAR STOOL

Design: Thore Lassen Design

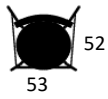

Frame		Frame colour Gr. 1	Frame colour Gr. 2		
PB1275					
Seat / back in PUR					
Seat / back colour gr. 1		597	611		
Seat / back colour gr. 2		611	630		
PB1175					
Upholstered seat (Fabric group 1: Xtreme / Camira Fabrics) / back in PUR					
Seat / back colour gr. 1		650	667		
Seat / back colour gr. 2		667	685		
Surcharge Fabric group (Fabric overview p. 89)	Gr. 2 12	Gr. 3 23	Gr. 4 43	Gr. 5 72	Gr. 6 * 84

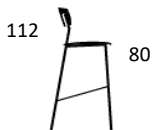

PB1276					
Seat / back in PUR					
Seat / back colour gr. 1		626	640		
Seat / back colour gr. 2		640	654		
PB1176					
Upholstered seat (Fabric group 1: Xtreme / Camira Fabrics) / back in PUR					
Seat / back colour gr. 1		681	695		
Seat / back colour gr. 2		695	710		
Surcharge Fabric group (Fabric overview p. 89)	Gr. 2 12	Gr. 3 23	Gr. 4 43	Gr. 5 72	Gr. 6 * 84

* Minimum 4 chairs

Surcharge	
Felt glides, set	14

Frame colour

Grp. 1



Black



Sandy grey



Chrome

Grp. 2



Dark petrol



Light
Sandy grey



Dusty
Olive



Terracotta



Warm
Charcoal



Satin
Chrome

PRODUCT HIGHLIGHTS

- Sound absorbing material
- Tilt glides with acoustic properties
- Can stack up to 4 high on the floor
- Easy to clean, can withstand ethanol-based disinfectants
- Soft-touch surface and solution dyed material
- Weight: Pure Bar w/backrest low 5,5 kg.
- Weight: Pure Bar w/backrest high 7,5 kg.



PURE X - CHAIR

Design: Thore Lassen Design



Frame	Frame colour Gr. 1
-------	-----------------------

PX1000	
Seat / back in PUR	
Seat / back colour gr. 1	435
Seat / back colour gr. 2	451

PX1100											
Upholstered seat (Fabric group 1: Xtreme / Camira Fabrics) / back in PUR											
Seat / back colour gr. 1	470										
Seat / back colour gr. 2	484										
Surcharge Fabric group (Fabric overview p. 89)	<table border="0"> <tr> <td>Gr. 2</td> <td>Gr. 3</td> <td>Gr. 4</td> <td>Gr. 5</td> <td>Gr. 6 *</td> </tr> <tr> <td>12</td> <td>23</td> <td>43</td> <td>72</td> <td>84</td> </tr> </table>	Gr. 2	Gr. 3	Gr. 4	Gr. 5	Gr. 6 *	12	23	43	72	84
Gr. 2	Gr. 3	Gr. 4	Gr. 5	Gr. 6 *							
12	23	43	72	84							



PXF1000	
Seat / back in PUR	
Seat / back colour gr. 1	535
Seat / back colour gr. 2	550

PXF1100											
Upholstered seat (Fabric group 1: Xtreme / Camira Fabrics) / back in PUR											
Seat / back colour gr. 1	589										
Seat / back colour gr. 2	603										
Surcharge Fabric group (Fabric overview p. 89)	<table border="0"> <tr> <td>Gr. 2</td> <td>Gr. 3</td> <td>Gr. 4</td> <td>Gr. 5</td> <td>Gr. 6 *</td> </tr> <tr> <td>12</td> <td>23</td> <td>43</td> <td>72</td> <td>84</td> </tr> </table>	Gr. 2	Gr. 3	Gr. 4	Gr. 5	Gr. 6 *	12	23	43	72	84
Gr. 2	Gr. 3	Gr. 4	Gr. 5	Gr. 6 *							
12	23	43	72	84							

* Minimum 4 chairs

Surcharge	
Glides	0
Wheels with brakes when not strained, set	14
Gas-lift XL, height 50-68 cm - PX1000 & PX1100 only	14
Tilt mechanism - not adjustable (height increased with 25 mm)	51
Loose footrest	84

Frame colour	
Grp. 1	Aluminium polished / black

- PRODUCT HIGHLIGHTS**
- Sound absorbing material
 - Chair hanger is available
 - Alu base - polished or matt black lacquered
 - Back hanger matt black lacquered
 - Tilt system is available
 - Footrest and glides are available
 - Adjustable seat height - 3 different heights
 - Easy to clean, can withstand ethanol-based disinfectants
 - Soft-touch surface and solution dyed material
 - Weight: Pure X 8 kg
 - Weight: Pure X w. footrest 9 kg

RAIL - CHAIRS

Design: Søren Nielsen & Thore Lassen

SEAT / BACK - GROUP 1



Birch

SEAT / BACK - GROUP 2



Ash
Black Lacquered

FRAME COLOURS - GROUP 1



Black
RAL 9005

FRAME COLOURS - GROUP 2



Chrome

ARMRESTS



Birch



Ash
Black Lacquered

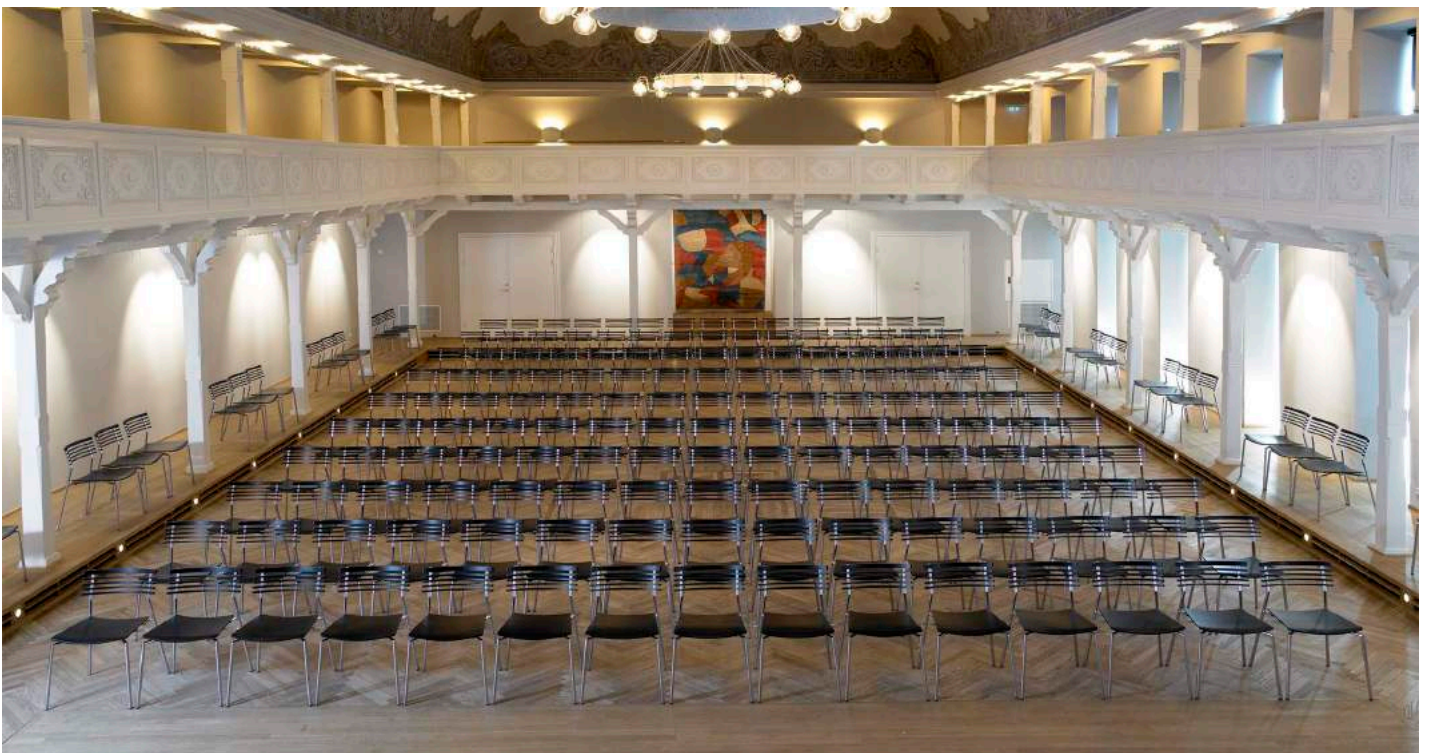





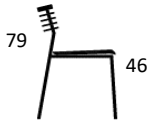

RAIL - CHAIR

Design: Søren Nielsen & Thore Lassen



Frame		Frame colour Gr. 1	Frame colour Gr. 2
R1000			
Seat / back in wood			
Seat / back in birch		386	418
Seat / back in black ash		416	449
R1100			
Upholstered seat (Fabric group 1: Xtreme / Camira Fabrics) / back in wood			
Back in birch		445	480
Back in black ash		476	511
Surcharge Fabric group (Fabric overview p. 89)	Gr. 2 12	Gr. 3 23	Gr. 4 43
	Gr. 5 72	Gr. 6 * 84	
* Minimum 4 chairs			
Surcharge			
Linking device - R1000 & R1100 only			41
Felt glides, set			8

Frame colour

Grp. 1



Black

Grp. 2



Chrome

PRODUCT HIGHLIGHTS





- Can stack up to 12 high on the floor
- Available with chair hanger
- Available with linking device
- Available with seat upholstery
- Weight: Rail 4,5 kg.

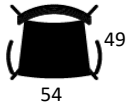
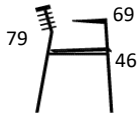

RAIL - ARMCHAIR

Design: Søren Nielsen & Thore Lassen



Frame		Frame colour Gr. 1	Frame colour Gr. 2		
R1050					
Seat / back and armrests in wood					
Seat / back in birch		537	570		
Seat / back in black ash		589	619		
R1150					
Upholstered seat (Fabric group 1: Xtreme / Camira Fabrics) / back in wood					
Back in birch		597	632		
Back in black ash		648	681		
Surcharge Fabric group (Fabric overview p. 89)	Gr. 2 12	Gr. 3 23	Gr. 4 43	Gr. 5 72	Gr. 6 * 84
* Minimum 4 chairs					
Surcharge					
Felt glides, set			8		

Frame colour

Grp. 1



Black

Grp. 2



Chrome

PRODUCT HIGHLIGHTS

- Can stack up to 6 high on the floor
- Available with seat upholstery
- Weight: Rail armchair 4,8 kg.



RAIL - BAR STOOL

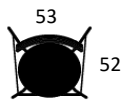
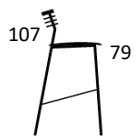

Design: Søren Nielsen & Thore Lassen



Frame	Frame colour
	Gr. 1



R1075

Seat / back

Seat / back in birch		636
Seat / back in black ash		664

R1175

Upholstered seat (Fabric group 1: Xtreme / Camira Fabrics) / back in wood

Back in birch		691
Back in black ash		718

Surcharge Fabric group (Fabric overview p. 89)	Gr. 2	Gr. 3	Gr. 4	Gr. 5	Gr. 6 *
	12	23	43	72	84

* Minimum 4 chairs

Surcharge

Felt glides, set	8
------------------	---

Frame colour

Grp. 1



Chrome

PRODUCT HIGHLIGHTS

- Can stack up to 5 high on the floor
- Available with chair hanger
- Available with seat upholstery
- Weight: Rail Bar 7,5 kg.

SCOPE - CHAIRS

Design: Hans-Thyge & Co.

SEAT / BACK



Oak Whitetinted
Lacquered



Oak
Smoked lacquered



Oak
Blacklacquered

FRAME COLOURS



Black
RAL 9005 Matt



Light Sandy Grey
NCS 2502 Y Matt

STETHOSCOPE



Black
RAL 9005 Matt



Light Sandy Grey
NCS 2502 Y Matt



Brass
Lacquered



Zinc

ARMREST (SCOPE LOUNGE & SCOPE ARMCHAIR)



Black
RAL 9005 Matt





SCOPE - CHAIR

Design: Hans-Thyge & Co.



52,5



47

Frame	Frame colour Black	Frame colour Light sandy grey			
SC1000					
Seat / back in oak					
	420	435			
SC1010-					
Upholstered seat (Fabric group 1: Xtreme / Camira Fabrics)	478	492			
Back in Oak					
Surcharge Fabric group (Fabric overview p. 89)	Gr. 2 12	Gr. 3 23	Gr. 4 43	Gr. 5 72	Gr. 6 * 84
SC1110-					
Upholstered seat and back (Fabric group 1: Xtreme / Camira Fabrics)	603	617			
Surcharge Fabric group (Fabric overview p. 89)	Gr. 2 35	Gr. 3 62	Gr. 4 123	Gr. 5 205	Gr. 6 * 238
* Minimum 4 chairs					
Surcharge					
Stethoscope in Brass / zinc, set		18			
Felt glides, set		14			

frame Colour

Gr. 1



Black

Gr. 2



Light sandy grey

PRODUCT HIGHLIGHTS

- Stethoscope 4 colours - Possibility for unique design
- Integrated felt pads - sound absorbing & protects upholstery
- Scope chair can stack 10 psc.
- Seat and back available in 3 colours
- Upholstery on seat and back
- Frame available in 2 colours
- FSC certified oak
- Metal 50 % recycled
- Approved L2 test (extreme use)
- Weight 4,5 kg.



SCOPE - ARMCHAIR

Design: Hans-Thyge & Co.



Frame	Frame colour Black	Frame colour Light sandy grey
-------	-----------------------	----------------------------------

SC1050

Seat / back in oak / armrest in PUR

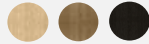

582

597

SC1060-

Upholstered seat (Fabric group 1: Xtreme / Camira Fabrics)

562

576

Back in Oak / armrest in PUR

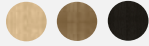

Surcharge Fabric group
(Fabric overview p. 89)

Gr. 2
12

Gr. 3
23

Gr. 4
43

Gr. 5
72

Gr. 6 *
84

SC1160-

Upholstered seat and back
(Fabric group 1: Xtreme / Camira Fabrics)

703

716

Surcharge Fabric group
(Fabric overview p. 89)

Gr. 2
35

Gr. 3
62

Gr. 4
123

Gr. 5
205

Gr. 6 *
238

* Minimum 4 chairs

Surcharge

Stethoscope in Brass / zinc, set

18

Felt glides, set

14

frame Colour

Gruppe 1



Black

Gruppe 2



Light sandy grey

PRODUCT HIGHLIGHTS

- Stethoscope 4 colours - Possibility for unique design
- Integrated felt pads - sound absorbing & protects upholstery
- Scope chair can stack 10 pcs.
- Seat and back available in 3 colours
- Upholstery on seat and back
- Frame available in 2 colours
- FSC Certified oak
- Metal 50% recycled
- Approved L2 test (extreme use)
- Weight: 5,3 kg.



SCOPE STOOL / BAR STOOL

Design: Hans-Thyge & Co.

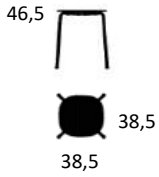

Frame	Frame colour				
	Black	Light sandy grey			
SCT1074					
Seat in oak					
	271	285			
SCT1274					
Upholstered seat (Fabric group 1: Xtreme / Camira Fabrics)					
	381	398			
Surcharge Fabric group (Fabric overview p. 89)	Gr. 2 12	Gr. 3 23	Gr. 4 43	Gr. 5 72	Gr. 6 * 84

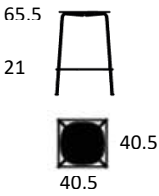

SCB1075					
Seat in oak					
	388	402			
SCB1275					
Upholstered seat (Fabric group 1: Xtreme / Camira Fabrics)					
	500	515			
Surcharge Fabric group (Fabric overview p. 89)	Gr. 2 12	Gr. 3 23	Gr. 4 43	Gr. 5 72	Gr. 6 * 84

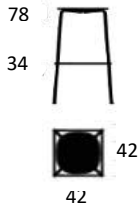

SCB1076					
Seat in oak					
	412	427			
SCB1276					
Upholstered seat (Fabric group 1: Xtreme / Camira Fabrics)					
	525	539			
Surcharge Fabric group (Fabric overview p. 89)	Gr. 2 12	Gr. 3 23	Gr. 4 43	Gr. 5 72	Gr. 6 * 84

* Minimum 4 chairs

Surcharge

Felt glides, set	14
------------------	-----------

Frame colour

Grp. 1		Black
Grp. 2		Light sandy grey

PRODUCT HIGHLIGHTS

- Stethoscope 4 colours - Possibility for unique design
- Integrated felt pads - sound absorbing & protects upholstery
- Scope Stool can stack 20 pcs. and 2 Scope bar
- Seat available in 3 colours
- Upholstery on seat
- Frame available in 2 colours
- FSC Certified oak
- Metal 50% recycled
- Approved L2 test (extreme use)
- Weight: Scope Stool 2,5 kg. Bar low 4,3 kg. Bar high 4,5 kg.



SCOPE - LOUNGECHAIR

Design: Hans-Thyge & Co.

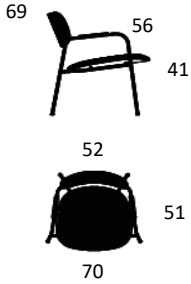

Frame	Frame colour Black	Frame colour Light sandy grey
SCL1610		
Upholstered seat (Fabric group 1: Xtreme / Camira Fabrics)	788	802
Back in Oak		
Surcharge Fabric group (Fabric overview p. 89)	Gr. 2 14	Gr. 3 25
	Gr. 4 51	Gr. 5 84
	Gr. 6 *	100
SCL1660		
Upholstered seat and back (Fabric group 1: Xtreme / Camira Fabrics)	956	970
Surcharge Fabric group (Fabric overview p. 89)	Gr. 2 41	Gr. 3 74
	Gr. 4 150	Gr. 5 246
	Gr. 6 *	287

* Minimum 4 chairs

Surcharge

Stethoscope in Brass / zinc, set	18
Felt glides, set	14

Frame colour

Grp. 1		Black
Grp. 2		Light sandy grey

PRODUCT HIGHLIGHTS

- Stethoscope 4 colours - Possibility for unique design
- Integrated felt pads - sound absorbing & protects upholstery
- Scope Stool can stack 5 pcs. on floor
- Back available in 3 colours
- Upholstery on back possible
- Frame available in 2 colours
- FSC Certified oak
- Metal 50% recycled
- Approved L2 test (extreme use)
- Weight: 6,9 kg.

TAC - CHAIRS

Design: byKATO

SEAT - MATT (PLASTIC/PA6)



White
RAL 9010



Black
RAL 9005



Grey
RAL 7030



Iceblue
NCS 3010BG

SEAT - SHINY FIBRE REINFORCED COMPOUNDS



White (Snow)
RAL 9010



Black
RAL 9005



Grey (Stone)
RAL 7030



Anthracite grey (Coal)
RAL 7016



Yellow (Lemon)
RAL 1012



Red (Coral)
RAL 3016



Turquoise (Sea)
RAL 5018

SEAT - MATT FIBRE REINFORCED COMPOUNDS



White
RAL 9010



Black
RAL 9005

LEGS



Oak
Whitepig. matt lacquer



Oak
Matt Lacquer



Oak
Black Lacquer



Walnut
Natural oil





TAC - CHAIR

Design: byKATO

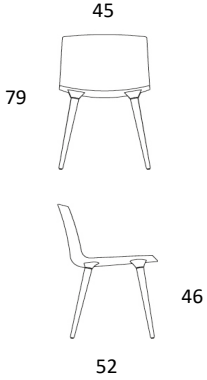

Frame	Oak Lacquered	Oak Black lacquered	Walnut Natural oil
2-3080			
Matt seat (plastic/PA6)			
	315	315	360
2-3090			
Shiny (fibre reinforced compounds) seat			
	505	505	530
CHOOSE YOUR OWN RAL-COLOUR - MINIMUM ORDER QUANTITY IS 10 CHAIRS IN THE SAME COLOUR			
2-3095			
Matt (fibre reinforced compounds) seat			
	505	505	530
Seat pad & Cover in black leather			
2-3097L111 Seat pad - 44,5x39 cm			65
2-3098L111 Cover - 74x48,5 cm			190
Felt and pvc floor protectors			
2-3089 1 set of felt and pvc floor protectors			15

Frame colour

Oak/Lacquer

Whietpigm. matt lacquer

Clear matt lacquer

Black lacquer

Walnut

Natural oil

PRODUCT HIGHLIGHTS

- W 5 kg (Model 2-3080) 6 kg (Model 2-3090/2-3095) / CBM 0,18 (Not stackable)
- Legs not mounted on delivery
- The TAC chair fulfils the requirements in EN 1022:2005 and EN 16139:2013. Furniture - Strength, durability and safety.

TONO - CHAIRS

Design: Hans-Thyge & Co.

SHELL COLOURS



Felt
Light Grey



Felt
Dark Grey

FRAME COLOURS (TONO 4-LEGS & TONO CONFERENCE)



Black
RAL 9005



Light Grey
RAL 7042

FRAME COLOURS (TONO WOOD)



Oak Whitetinted
Lacquered



Ash
Lacquered



Ash
Black Lacquered





TONO 4-LEGS - CHAIR

Design: Hans-Thyge & Co.

Frame

Frame colour

Gr. 1

T1250

Seat cushion upholstered (Fabric group 1: Xtreme / Camira Fabrics) / shell of felt

Felt gr. 1

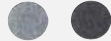

742

Surcharge Fabric group
(Fabric overview p. 89)

Gr. 2
12

Gr. 3
21

Gr. 4
41

Gr. 5
68

Gr. 6 *
117

T1350

Seat cushion and inner back upholstered

Fabric: Re-wool

997

Fabric: Hallingdal

1.044

Inner back can only be upholstered with Re-wool or Hallingdal.
The fabric on the inner back and the seat cushion must be the same.

* Minimum 4 chairs

Surcharge

Felt glides, set

14

Frame colour

Grp. 1



Black



Light Grey

PRODUCT HIGHLIGHTS

- Passed L2 (extreme use)
- The felt shell is 100% reusable
- Elegant seat cushion - non-removable
- Sound absorbing felt shell
- Ergonomic back support
- Weight: Tono 4-Legs 5,6 kg.

79



46



53

56



TONO WOOD - CHAIR

Design: Hans-Thyge & Co.

Frame

Frame colour

Gr. 1

TW1250

Seat cushion upholstered (Fabric group 1: Xtreme / Camira Fabrics) / shell of felt

Felt gr. 1

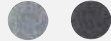

974

Surcharge Fabric group
(Fabric overview p. 89)

Gr. 2
12

Gr. 3
21

Gr. 4
41

Gr. 5
68

Gr. 6 *
117

TW1350

Seat cushion and inner back upholstered

Fabric: Re-wool

1.204

Fabric: Hallingdal

1.247

Inner back can only be upholstered with Re-wool or Hallingdal.
The fabric on the inner back and the seat cushion must be the same.

* Minimum 4 chairs

Surcharge

Felt glides, set

8

Frame colour

Grp. 1



Oak
White tinted



Ash
White tinted



Ash
Black lacq.

PRODUCT HIGHLIGHTS

- Passed L2 (extreme use)
- The felt shell is 100% reusable
- Elegant seat cushion - non-removable
- Sound absorbing felt shell
- Ergonomic back support
- Weight: Tono Wood 5 kg.

79



46



53

56



TONO CONFERENCE - CHAIR

Design: Hans-Thyge & Co.

Frame

Frame colour

Gr. 1

T1400

Seat cushion upholstered (Fabric group 1: Xtreme / Camira Fabrics) / shell of felt

Felt gr. 1



1.025

Surcharge Fabric group
(Fabric overview p. 89)

Gr. 2
12

Gr. 3
21

Gr. 4
41

Gr. 5
68

Gr. 6 *
117

T1450

Seat cushion and inner back upholstered

Fabric: Re-wool

1.253

Fabric: Hallingdal

1.296

Inner back can only be upholstered with Re-wool or Hallingdal.
The fabric on the inner back and the seat cushion must be the same.

* Minimum 4 chairs

Frame colour

Grp. 1



Black



Light grey

PRODUCT HIGHLIGHTS

- The felt shell is 100% reusable
- Swivel chair - with 360 degree swivel base
- Elegant seat cushion - non-removable
- Sound absorbing felt shell
- Ergonomic back support
- Weight: Tono Conference 8,4 kg

79



46

Ø67



53

56

CHAIR TROLLEYS

Price



D19900

Dry trolley, 20 chair capacity

1.110

Dimension LxWxH without chairs: 81x47x93 cm

Dimension LxWxH with 20 chairs (without upholstery): 118x52x140 cm



MO19900

Mood trolley, 20 chair capacity

972

Dimension LxWxH without chairs: 79x44x120 cm

Dimension LxWxH with 20 chairs (without upholstery): 117x51x190 cm



M1036

Hand truck trolley (universal)

414

CHAIR SUSPENSION

CHAIR	ITEM NO. Chair suspension	PRICE 1 pcs. suspension	TABLE			
			GRIP	TUBE FOLD	TUBE BASIC	TUBE STAY
PURE	STPURE	39	√	√	√	√
DRY	STDY	41	√	÷	÷	√
MOOD	STMOOD	39	√	√	√	√
MUST	STMUST	39	÷	√	√	√
SCOPE	STSCOPE	49	√	÷	÷	√

SOFAS - DAYBED



FABRIC/LEATHER GROUPS - SOFAS

FABRIC GROUP A

Floyd
Remix 3

FABRIC GROUP B

Canvas 2
Re-Wool

FABRIC GROUP C

Fiord 2
Hallingdal 65
Divina 3
Divina Melange
Steelcut Quartet
Steelcut Trio

All the above mentioned fabrics are from Kvadrat

LEATHER GROUP L

Sevilla S4001 (Black)
Sevilla S4003 (Cognac)





A1 - SOFA AND POUF

Design: byKATO

Upholstery

C.O.M. * Fabric gr. Fabric gr. Fabric gr. Leather
A B C L

Legs/Frame in Oak - Choose between: Whitepigmented matt lacquer / Black lacquer

3-601- W90xD55xSH44 cm

A1 Pouf

Frame: Oak Lacquered

1.125 1.255 1.335 1.490 1.570

3-602- W90xD55xSH44 cm

A1 Sofa - 2½ persons

Frame: Oak Lacquered

2.930 3.465 3.780 4.250 4.725

3-603- W90xD55xSH44 cm

A1 Sofa - 3 persons

Frame: Oak Lacquered

3.360 3.935 4.410 5.040 5.195

* Customers Own Material

Frame colour

Oak / Lacquered



PRODUCT HIGHLIGHTS

- Model 3-601: W 13 kg / CBM 0,15
- Model 3-602: W 70 kg / CBM 1,12
- Model 3-603: W 82 kg / CBM 1,35

Fabric/Leather consumption:

- Model 3-601: Fabric: 2 m / Leather: 3,5 m2
- Model 3-602: Fabric: 7 m / Leather: 14,2 m2
- Model 3-603: Fabric: 8,5 m / Leather: 17 m2

Model 3-601

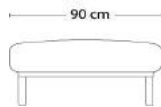

Model 3-602 / 3-603

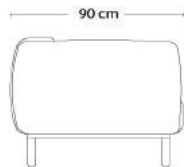

Model 3-602

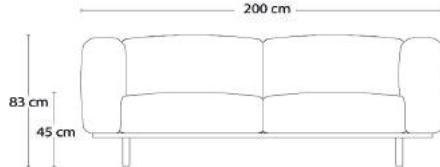

Model 3-603

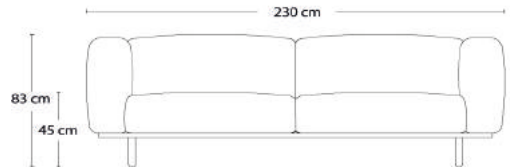



A2 - SOFA

Design: Louise Siig Nielsen

Upholstery

	C.O.M.*	Fabric gr.		
		A	B	C
3-6501- W55xD90xH78 / SH46 cm Straight modular	595	900	970	1.125
3-6502- W55xD90xH46 / SH46 cm Pouf	455	670	740	870
3-6505- W90xD90xH78 / SH46 cm Corner modular - round	955	1.400	1.500	1.770
3-6506- W90xD90xH78 / SH46 cm Corner modular - 90 degr.	1.015	1.500	1.700	1.945
3-6509- W110xD90xH78 / SH46 cm Straight modular	925	1.355	1.430	1.630

* Customers Own Material

PRODUCT HIGHLIGHTS

- Model 3-6501: W 20 kg / CBM 0,39
- Model 3-6502: W 15,5 kg / CBM 0,23
- Model 3-6505: W 27 kg / CBM 0,63
- Model 3-6506: W 36 kg / CBM 0,63

Fabric consumption:

- Model 3-6501: 3,5 m
- Model 3-6502: 2,6 m
- Model 3-6505: 5,5 m
- Model 3-6506: 6,5 m

Model 3-6501

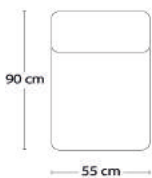
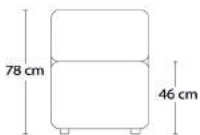

Model 3-6502

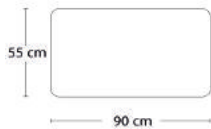

Model 3-6505

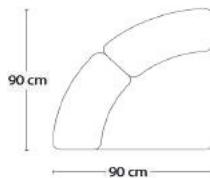
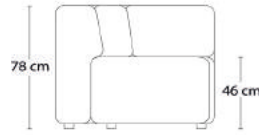

Model 3-6506

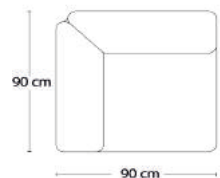
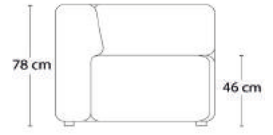

Model 3-6509

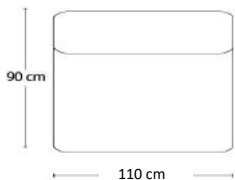



A3 - SOFA

Design: Charlotte Høncke

Upholstery

C.O.M. * Fabric gr. Fabric gr. Fabric gr.
A B C

Legs: Oak / Whitepig. matt lacquer

3-6701- 96x78xH132/SH45 cm

Sofa - High back module - Right

1.090 1.935 2.080 2.440

3-6702- 96x78xH132/SH45 cm

Sofa - High back module - Left

1.090 1.935 2.080 2.440

3-6703- 102x78xH132/SH45 cm

Chair - High back module

1.350 2.010 2.225 2.580

3-6704- 96x78xH82/SH45 cm

Sofa - Low back module - Right

1.020 1.405 1.505 1.795

3-6705- 96x78xH82/SH45 cm

Sofa - Low back module - Left

1.020 1.405 1.505 1.795

3-6706- 102x78xH82/SH45 cm

Chair - Low back module

1.105 1.580 1.720 2.010

3-6707- 90x72xH45 cm

Pouf

660 790 860 935

3-6708- 90x72xH26,5 cm

Pouf incl. top in solid oak

585 625 685 710

3-6710

Power (1 x 230 V og 2 x USB-A)

360

3-6720 32x52xH65 cm

Side table - top in oak/steel grey metal

430

* Customers Own Material

Frame colour

Oak/Lacquer



Whitepig. matt Lacquer

PRODUCT HIGHLIGHTS

- Model 3-6701: W 39 kg / CBM 0,98
- Model 3-6702: W 39 kg / CBM 0,98
- Model 3-6703: W 44 kg / CBM 1,04
- Model 3-6704: W 30,5 kg / CBM 0,62
- Model 3-6705: W 30,5 kg / CBM 0,62
- Model 3-6706: W 33 kg / CBM 0,0,65
- Model 3-6707: W 20 kg / CBM 0,37
- Model 3-6708: W 22 kg / CBM 0,21
- Model 3-6720: W 6,5 kg / CBM 0,11

Fabric consumption:

- Model 3-6701: 5,5 m
- Model 3-6702: 5,5 m
- Model 3-6703: 6,5 m
- Model 3-6704: 4 m
- Model 3-6705: 4 m
- Model 3-6706: 4,5 m
- Model 3-6707: 2 m
- Model 3-6708: 1 m

A3 - SOFA

Design: Charlotte Højncke

Model 3-6701

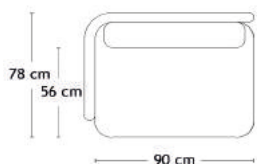
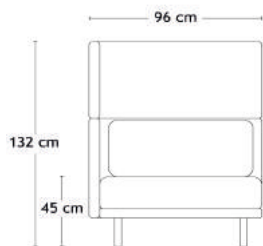

Model 3-6702

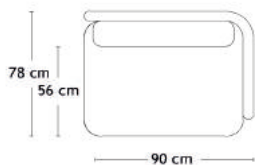
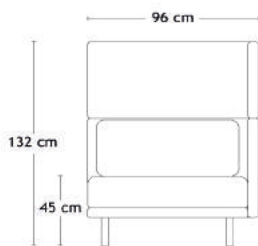

Model 3-6703

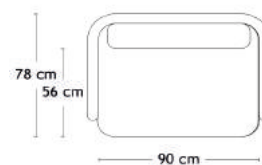
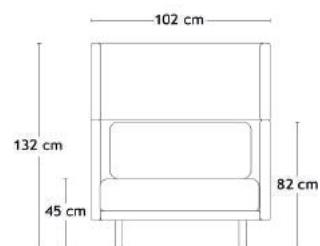

Model 3-6704

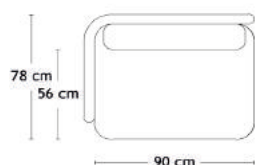
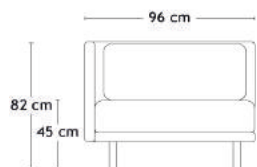

Model 3-6705

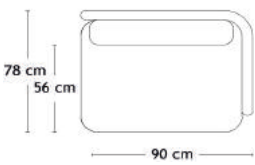
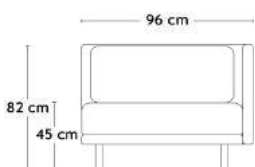

Model 3-6706

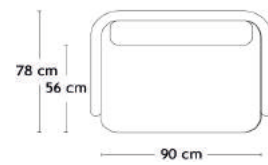
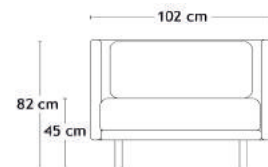

Model 3-6707

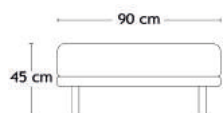

Model 3-6708

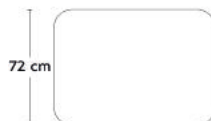
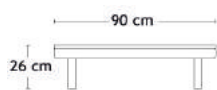

Model 3-6720

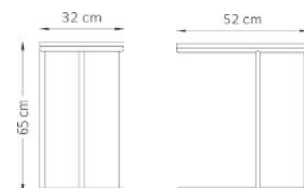



DB1 - ARCTIC DAYBED

Design: Louise Siig Nielsen

Upholstery	Black Leather	Cognac Leather
3-630 190x76xH35,5 cm		
Legs: Oak/Whitepigmented mat lacquer		2.010
Legs: Oak/Black lacquered	2.010	
Surcharge - Pillow	Black Leather	Cognac Leather
3-631 Pillow - 50x26xH7 cm	145	145

PRODUCT HIGHLIGHTS

- Model 3-631: W 32 kg / CBM 0,5

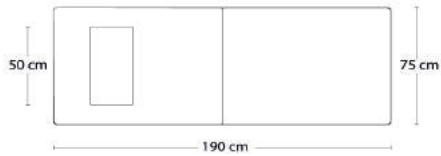

STORAGE



S1 - S2 SERIES

Design: byKATO

DOORS - LAMINATE



White (Alpino)
K1040



Kashmir
F0187



Cafe
F0903



Terril
F2297



Diamond Black
F2253



Ocean Grey
F7853



Pumice
F7858



Silver
F2791



Iron
F7902



Pale Olive
F3007



Artic Blue
F5493



Lead
F7924



Mouse
F7928

DOORS - LOUDSPEAKER FABRIC (Only for S2)



Black

TYPES OF WOOD - LEGS



Oak
Soap



Oak
White oil



Oak
Natural oil



Oak
Black lacquer



Walnut
Natural oil



S1 - SIDEBOARD

Design: byKATO

Cabinet	Oak Soap	Oak Oil*	Black Lacquer	Walnut Natural oil
5-110A L200xD50xH68 cm (incl. plinth) Incl. 4 doors + 4 shelves **	4.080	4.225	3.720	5.585
Choose between: White oil / Natural oil				
** The doors are reversible and supplied with black laminate on one side				
The other side of the door is available in a selection of different coloured laminates				
Tray		Oak Soap	Oak Oil*	Walnut Natural oil
Tray in solid wood w/tenon jointed edges 5-135T B47xD41,5xH7 cm		215	215	260
Extra shelf				Black
Shelf 5-140				90
Extra door				Laminate
Door 5-150A				245
Drilling				Surcharge
Drilling D60mm - incl. cover for drilling D60 mm Choose among standard placements as shown. Please state placements (letter ar				50

PRODUCT HIGHLIGHTS

- Model 5-110A: W 80 kg / CBM 0,6

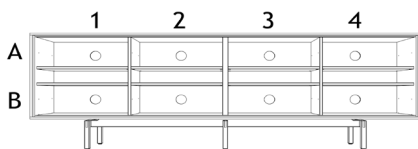
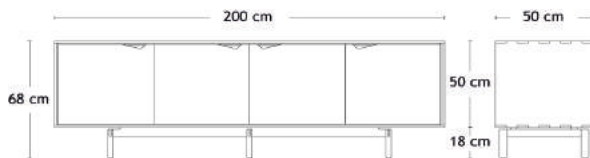

Drilling - Please state placements (letter and number)

S2 - SHELF SYSTEM (HEIGHT 32 CM)

Design: byKATO

Cabinet	Oak Soap	Oak Oil*	Black Lacquer	Walnut Natural Oil
5-303 L60xD36 cm 1-room element H32 cm	885	925	885	1.570
5-307 L118xD36 cm 2-room element H32 cm	1.140	1.215	1.140	2.145

Door Laminate

Door with laminate and black edge (Notice: Non-reversible doors) **

5-362 Door - left	225
5-367 Door - right	225

* Oak/Oil - Choose between: White oil - Natural oil

** Remember to indicate whether the door should be right hinged or left hinged

Tray ***	Laminate	Oak Soap	Oak Oil*
Tray - L56xD30xH8 cm			
5-375 Solid wood		130	130
5-370A Laminate	290		

*** Remember to order a shelf for each tray

Shelf Black

Shelf

5-348 Shelf - 56x32 cm	60
5-350 Shelf behind door - 56x30 cm	60

Legs / Mountinglist

5-380 Legs in black metal - H24 cm (4 pcs.)	245
5-382 Round wooden legs with a brass ring - H24 cm (4 pcs.)	245
5-390 Mountinglist for 1-room element	90
5-395 Mountinglist for 2-room element	100

PRODUCT HIGHLIGHTS

- Model 5-303: W 12 kg / CBM 0,10

- Model 5-307: W 22 kg / CBM 0,16





S2 - SHELF SYSTEM (HEIGHT 51 CM)

Design: byKATO

Cabinet	Oak Soap	Oak Oil*	Black Lacquer	Walnut Natural Oil
5-300 L60xD36 cm 1-room element H51 cm	925	970	925	1.570
5-305 L118xD36 cm 2-room element H51 cm	1.215	1.285	1.215	2.215
Door				Laminate
Door with laminate and black edge (Notice: Non-reversible doors) **				
5-360 Door - left				225
5-365 Door - right				225
* Oak/Oil - Choose between: White oil - Natural oil				
** Remember to indicate whether the door should be right hinged or left hinged				
Tray ***	Laminate	Oak Soap	Oak Oil*	
Tray - L56xD30xH8 cm				
5-375 Solid wood		130	130	
5-370A Laminate	290			
*** Remember to order a shelf for each tray				
Shelf				Black
Shelf				
5-348 Shelf - 56x32 cm				60
5-350 Shelf behind door - 56x30 cm				60
Legs / Mountinglist				
5-380 Legs in black metal - H24 cm (4 pcs.)				245
5-382 Round wooden legs with a brass ring - H24 cm (4 pcs.)				245
5-390 Mountinglist for 1-room element				90
5-395 Mountinglist for 2-room element				100

PRODUCT HIGHLIGHTS

- Model 5-300: W 22 kg / CBM 0,16
- Model 5-305: W 36 kg / CBM 0,27

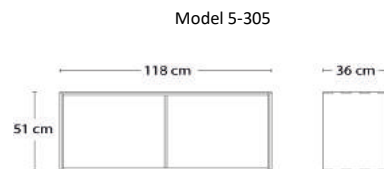
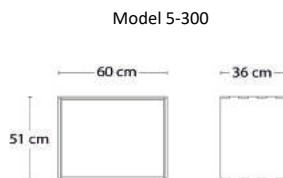

S2 - SHELF SYSTEM (TV-MODULE)

Design: byKATO

Cabinet	Oak Soap	Oak Oil*	Black Lacquer	Walnut Natural Oil
5-308 L118xD36 cm				
TV-Module H32 cm	1.140	1.215	1.140	2.145

Door		Loudspeaker fabric
Door with black loudspeaker fabric (Notice: Non-reversible doors) **		
5-364	Door - left	230
5-369	Door - right	230

* Oak/Oil - Choose between: White oil - Natural oil

** Remember to indicate whether the door should be right hinged or left hinged

Door		Laminate
Door with laminate and black edge (Notice: Non-reversible doors) *		
5-362	Door - left	225
5-367	Door - right	225

* Remember to indicate whether the door should be right hinged or left hinged

Tray ***	Laminate	Oak Soap	Oak Oil*
Tray - L56xD30xH8 cm			
5-375	Solid wood	130	130
5-370A	Laminate	290	

*** Remember to order a shelf for each tray

Shelf		Black
Shelf		
5-348	Shelf - 56x32 cm	60
5-350	Shelf behind door - 56x30 cm	60

Legs / Mountinglist

5-380	Legs in black metal - H24 cm (4 pcs.)	245
5-382	Round wooden legs with a brass ring - H24 cm (4 pcs.)	245
5-397	Mountinglist for TV-Module	100

PRODUCT HIGHLIGHTS

- Model 5-300: W 22 kg / CBM 0,16

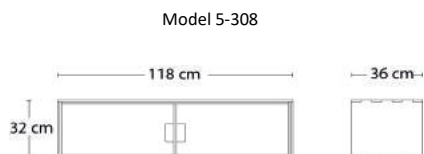







S3 - S5 - S6 - S7 - S8 SERIES

Design: byKATO

FRONTS - LAMINATE

Choose between the following fronts:

- Alpino 
White (Alpino)
K1040
- Ocean Grey 
Ocean Grey
F7853
- Kashmir 
Kashmir
F0187
- Multi Sand   
Silver Pumice Iron
F2791 F7858 F7902

TYPES OF WOOD - LEGS



Oak
Soap



Oak
White Oil



Oak
Natural oil



Oak
Black Lacquer



Walnut
Natural Oil



S3 - S5 STORAGE

Design: byKATO

Cabinet	Oak Soap	Oak Oil*	Black Lacquer	Walnut Natural Oil
5-505 B130xD43xH132 cm S3 storage incl. 3 shelves	4.295	4.440	4.150	5.655

5-515 B83xD43xH132 cm S5 storage incl. 1 shelf	3.720	3.865	3.580	5.010
---	--------------	--------------	--------------	--------------

* Oak/Oil - Choose between: White oil - Natural oil

Shelf		Black
5-510H307	B31xD38 cm	50
5-510H467	B47xD38 cm	55

Brushed steel rings to mount on legs		Surcharge
5-511	4 pcs. Brushed steel rings	25

Choose between the following front:

Alpino

Ocean Grey

Kashmir

Multi Sand

PRODUCT HIGHLIGHTS

- Model 5-505: W 85 kg / CBM 1,61

- Model 5-515: W 75 kg / CBM 0,68

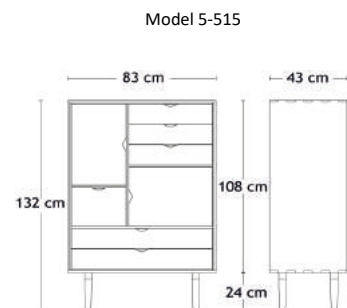
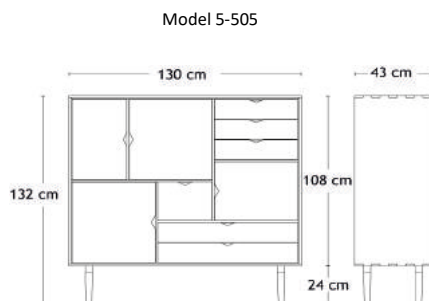



S6 - S7 SIDEBOARD

Design: byKATO

Cabinet	Oak Soap	Oak Oil*	Black Lacquer	Walnut Natural Oil
5-525 B163xD43xH80 cm S6 sideboard incl. 2 shelves	3.290	3.435	3.150	5.300



5-530 B163xD43xH80 cm S7 sideboard incl. 4 shelves	2.720	2.860	2.575	4.725
--	--------------	--------------	--------------	--------------

* Oak/Oil - Choose between: White oil - Natural oil

Shelf	Black
-------	-------

Shelf		
5-510H307	B31xD38 cm	50
5-510H467	B47xD38 cm	55

Brushed steel rings to mount on legs	Surcharge
--------------------------------------	-----------

5-511 4 pcs. Brushed steel rings	25
----------------------------------	-----------

Choose between the following front:

Alpino 

Ocean Grey 

Kashmir 

Multi Sand   

PRODUCT HIGHLIGHTS

Model 5-525: W 77 kg / CBM 0,46

Model 5-530: W 60 kg / CBM 0,46

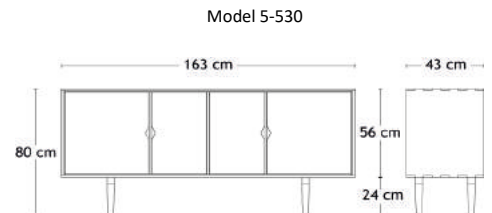
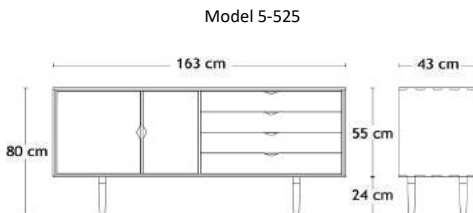



S8 - STORAGE

Design: byKATO

Cabinet	Oak Soap	Oak Oil	Black Lacquer	Walnut Natural Oil
5-520 B83xD43xH107 cm				
S8 storage	3.150	3.290	3.005	4.725

* Oak/Oil - Choose between: White oil - Natural oil

Brushed steel rings to mount on legs				Surcharge
5-511 4 pcs. Brushed steel rings				25

Choose between the following front:

Alpino 

Ocean Grey 

Kashmir 

Multi Sand 

PRODUCT HIGHLIGHTS

- Model 5-520: W 60 kg / CBM 0,42

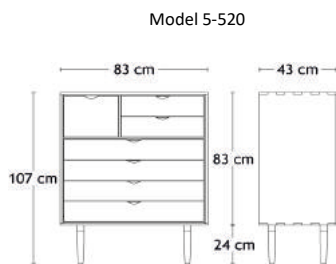



S10 - SIGNATURE CABINETS

Design: Andersen Design Team

		Oak veneer Whitepig. matt lack
7-140020	B38xD30xH38 cm Cabinet with door	260
7-140021	B38xD30xH38 cm Cabinet without door	200
Shelf		Oak veneer
Shelf		
7-140022	B35,5xD26xH1,3 cm	55

Material

Oak/Veneer



Whitepig.
matt lacquer

PRODUCT HIGHLIGHTS

- Model 7-140020: W 6,2 kg / CBM 0,043
- Model 7-140021: W 5 kg / CBM 0,043
- Model 7-140022: W 1 kg / CBM 0,001

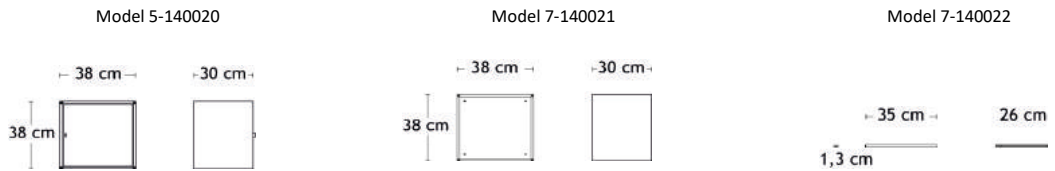



UNIQUES SIDEBOARD - HIGHBOARD

Design: byKATO

Cabinet - Sideboard	Oak veneer Black lacquer	Oak veneer Whitepig. matt lack
7-111001 B163xD43xH80 cm Oak veneer doors Sideboard incl. 4 shelves	2.145	
7-111020 B163xD43xH80 cm Oak veneer doors Sideboard incl. 4 shelves		2.145



Cabinet - Highboard	Oak veneer Black lacquer	Oak veneer Whitepig. matt lack
7-115001 B131xD43xH132 cm Oak veneer doors Highboard incl. 3 shelves	2.860	
7-115020 B131xD43xH132 cm Oak veneer doors Highboard incl. 3 shelves		2.860

Cabinet

Oak/Veneer



Front

Oak/Veneer



PRODUCT HIGHLIGHTS

- Model 7-111001 / 7-111020: W 46 kg / CBM 0,43
- Model 7-115001 / 7-115020: W 82 kg / CBM 0,75

Model 7-111001 / 7-111020

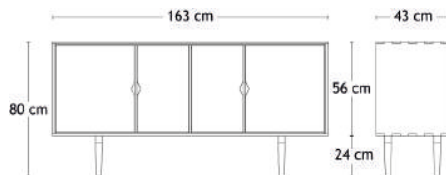

Model 7-115001 / 7-115020

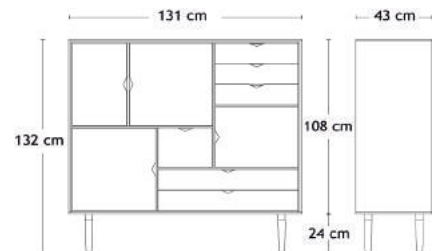

RUGS



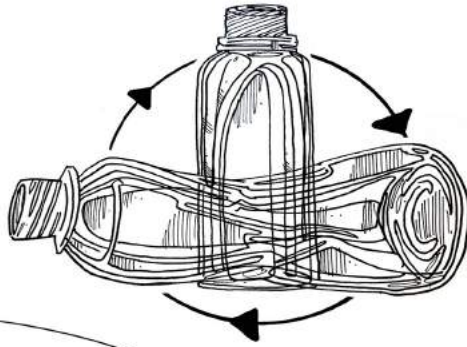

The felt material on the back of the rug is made from recycled plastic bottles

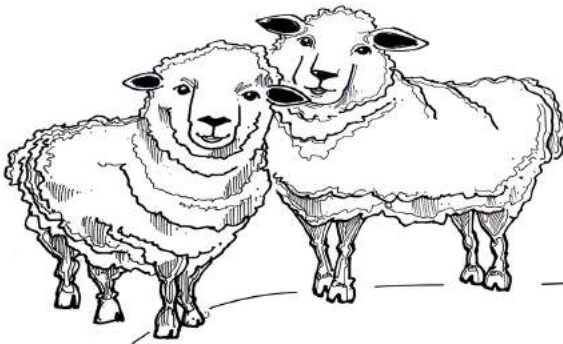

Flow consists of 80% high-quality wool from New Zealand sheep - the remaining 20% is polyamide

Cradle to Cradle certified – based on that the product must not have a negative impact on the planet

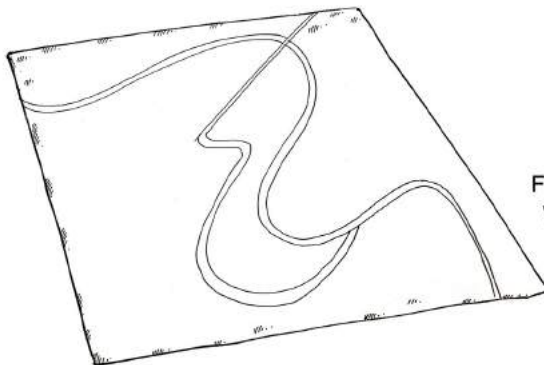

Flow Rug
Warmth and contrast for the home
- with a clear conscience



FLOW - RUG

Design: Raket Villesen

Rugs

80% Wool
20% Polyamide



7-510001

Rug 140x200 cm

720

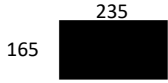

7-510002

Rug 165x235 cm

860



7-510003

Rug 200x300 cm

1.290



Design Concept Denmark A/S | Zeta 1 | DK-8382 Hinnerup | +45 27 40 08 08
info@designconceptdenmark.dk | andersen-furniture.dk